

Surgiforce
Instruments

Page
535-551

▪ Micro Instruments



www.surgiforce.com

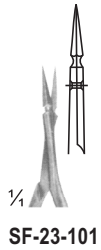
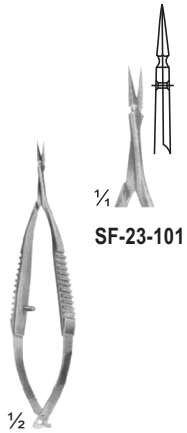

SF-23-101



SF-23-102



SF-23-103

SF-23-101 - SF-23-103
VANNAS
85 mm



SF-23-104

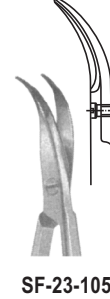

SF-23-105

SF-23-104 - SF-23-105
CASTROVIEJO
95 mm

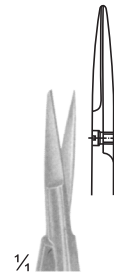
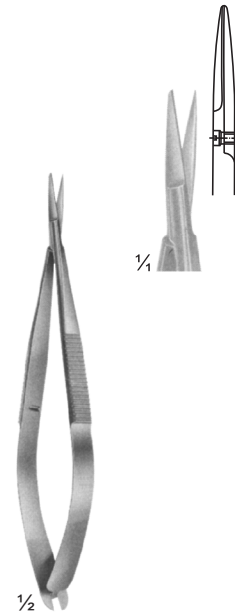

1/4

SF-23-106
NOYES
125 mm

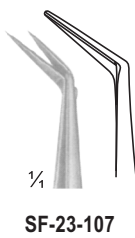
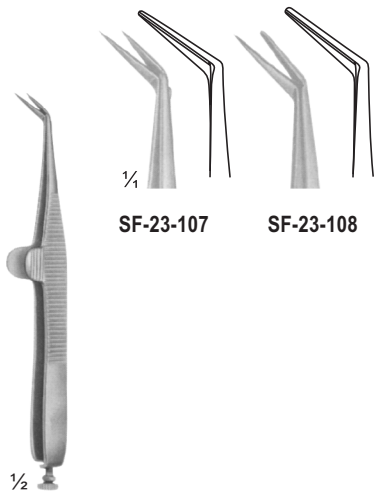

SF-23-107

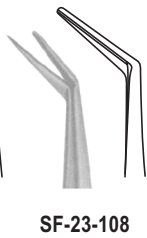

SF-23-108

SF-23-107 - SF-23-108
WECKER
Eye Scissor
110 mm

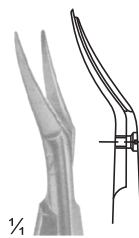
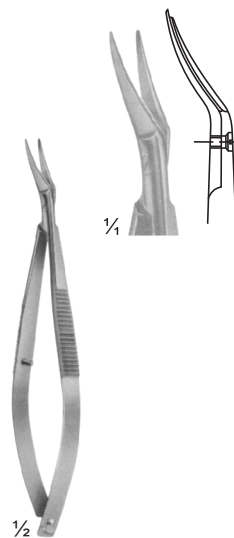

1/4

SF-23-109
CASTROVIEJO
Eye Scissor
115 mm

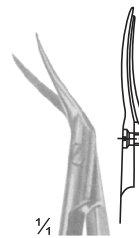
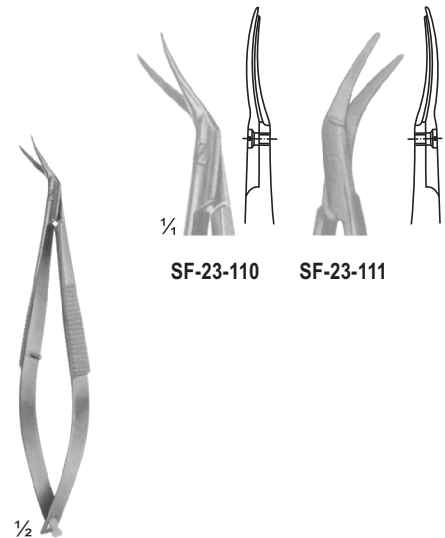

1/4

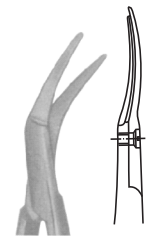

SF-23-111

SF-23-110 - SF-23-111
CASTROVIEJO
Eye Scissor
110 mm

MICRO SCISSORS "SPRING TYPE" FLAT HANDLES

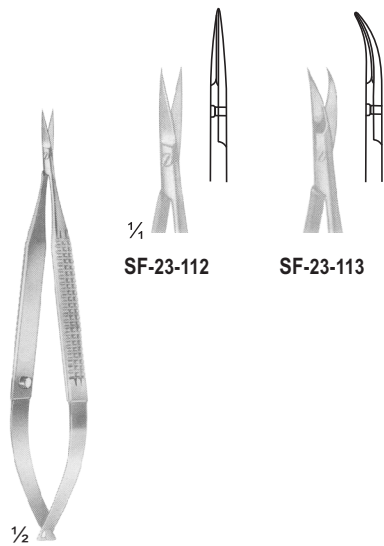

SF-23-112 - SF-23-113
120 mm

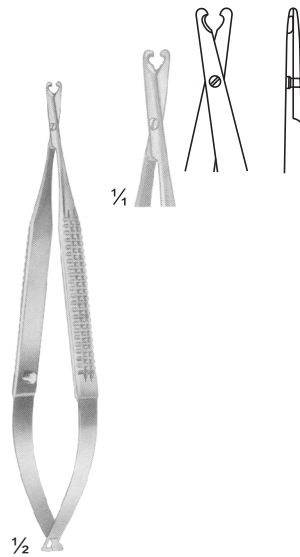

SF-23-114
BIEMER
Vein Scissor
130 mm

SF-23-115
160 mm

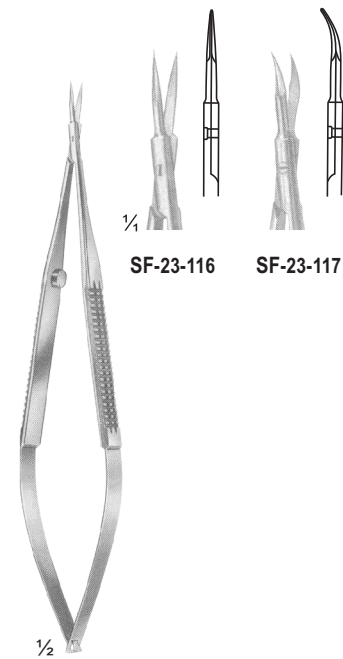

SF-23-116 - SF-23-117
VANNAS
160 mm

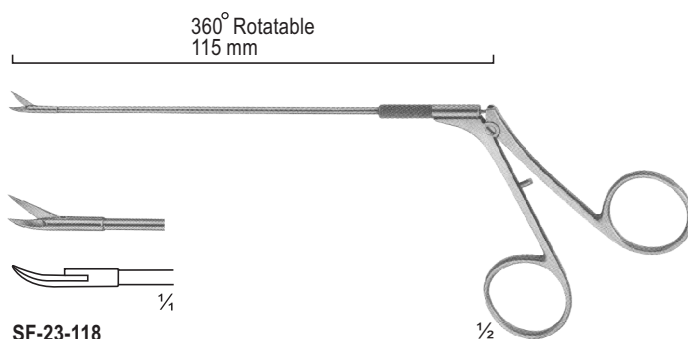

SF-23-118
CASPAR
Micro Scissor Curved
115 mm

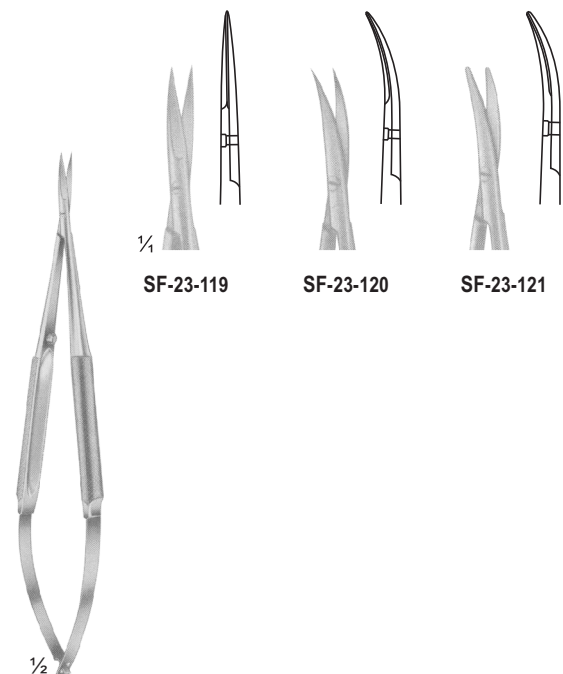

SF-23-119 - SF-23-121
Micro Dissecting Scissor
145 mm

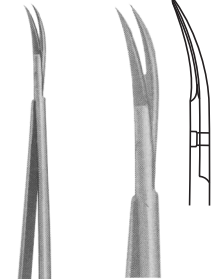

1/2
SF-23-122
YASARGIL
245 mm

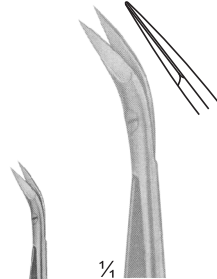

1/4
SF-23-123

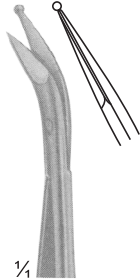

1/4
SF-23-124



1/2
SF-23-123 - SF-23-124
Laterally Angled
200 mm

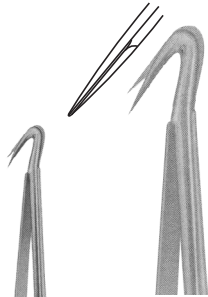

1/2
SF-23-125
Laterally Angled
190 mm

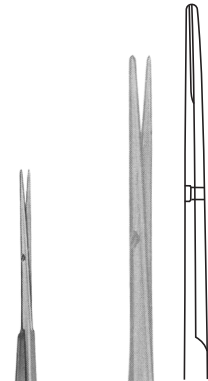

1/4
SF-23-126

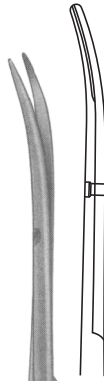

1/4
SF-23-127



1/2
SF-23-126 - SF-23-127
YASARGIL
225 mm

MICRO SPRING SCISSORS

www.surgiforce.com



SF-23-128



SF-23-129



SF-23-130



SF-23-131



SF-23-132



SF-23-133



SF-23-134



SF-23-135

SF-23-128 - SF-23-129
CASTROVIEJO
Spring Scissors
15, 18 cm

SF-23-130 - SF-23-132
STREAMLINE
Micro Coronary
Scissors
15, 18, 21, 23 cm

SF-23-133
STREAMLINE
Spring Scissors
23 cm

SF-23-134 - SF-23-135
STREAMLINE
Spring Scissors
23 cm



SF-23-136



SF-23-137

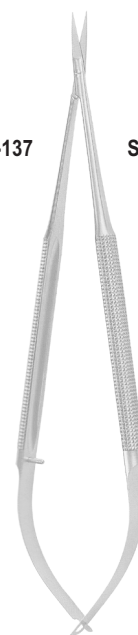

SF-23-138



SF-23-139

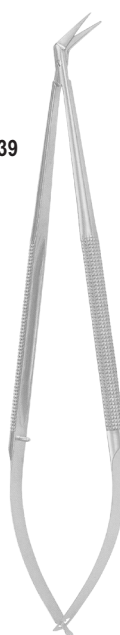

SF-23-140

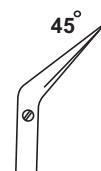

SF-23-141

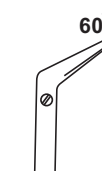

SF-23-142

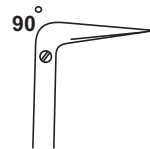

SF-23-143

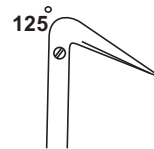

SF-23-144



SF-23-145



SF-23-146



SF-23-147

SF-23-136 - SF-23-137
TOLEDO
Spring Scissors
16.5 cm

SF-23-138 - SF-23-139
BARRAQUER
Spring Scissors
12, 15, 18 cm

SF-23-140 - SF-23-144
BARRAQUER
Spring Scissors
18 cm

SF-23-145 - SF-23-147
BARRAQUER
Spring Scissors
Bayonet
22 cm

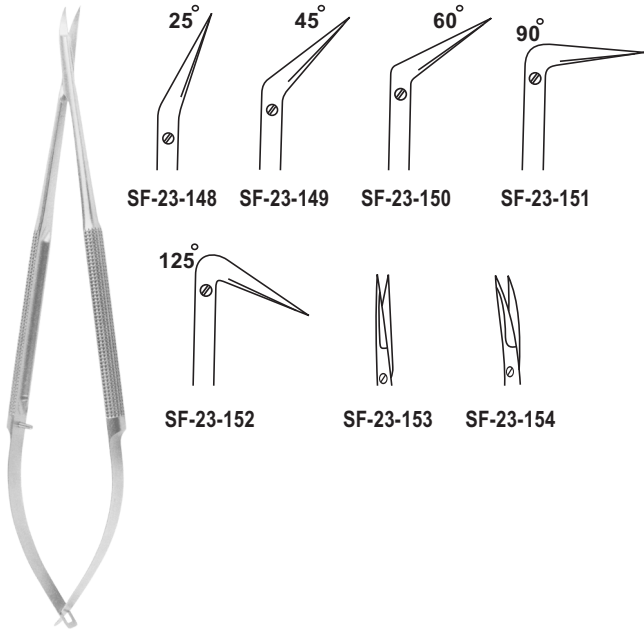

SF-23-148 - SF-23-154
STREAMLINE
Spring Scissors
18, 21 cm

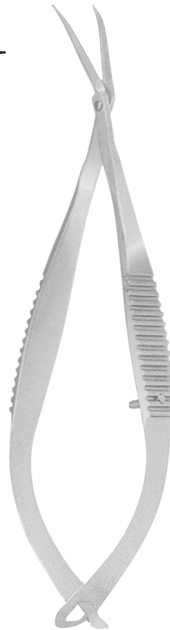

SF-23-155
ONG-TREUMER
Capsulotomy Scissors
8 cm



SF-23-156
VANNAS-TUBINGEN
After-Cataract Scissors
8 cm
8 mm



SF-23-157
WESTCOTT
Tenotomy Scissors
11 cm

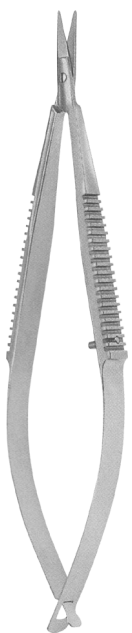

SF-23-158
WESTCOTT
Micro-Tenotomy
Scissors
10.5 cm



SF-23-159
Micro Spring
Scissors
10.5 cm
12 mm



SF-23-160
CASTROVIEJO
Corneal Scissors
10.5 cm

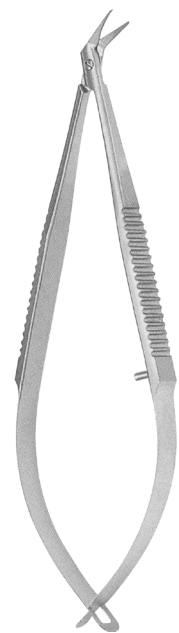

SF-23-161
TROUTMAN
Corneal Scissors
10 cm



SF-23-162
BONN
Eye Scissors
9 cm



SF-23-163
Eye Scissors
10.6 cm

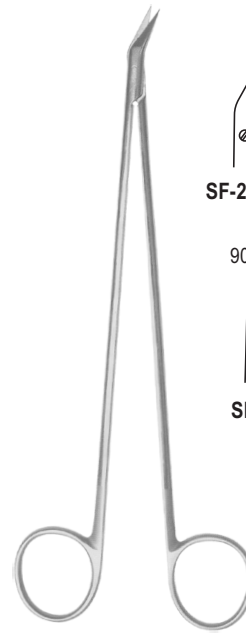

SF-23-164 - SF-23-168
HEGEMANN
Ring Scissors
18 cm

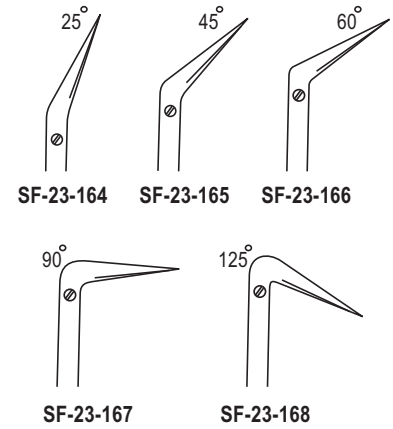

SF-23-169 - SF-23-173
TOLEDO
Forceps Heavy
18, 21 cm

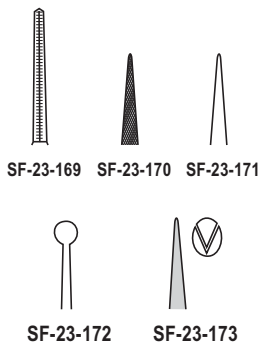

SF-23-174 - SF-23-178
TOLEDO
Forceps
15, 18 cm

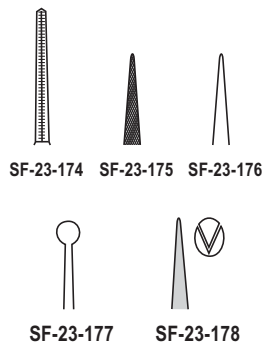

SF-23-179 - SF-23-183
TOLEDO
Forceps
18, 21 cm

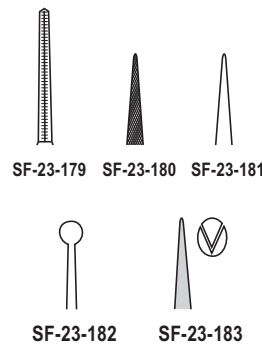

SF-23-184 - SF-23-188
TOLEDO
Forceps
15, 18, 21 cm

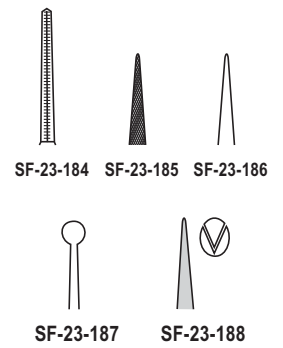

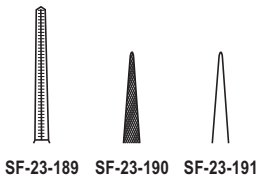

SF-23-189 SF-23-190 SF-23-191



SF-23-192 SF-23-193

SF-23-189 - SF-23-193
Forceps
15, 18, 21 cm

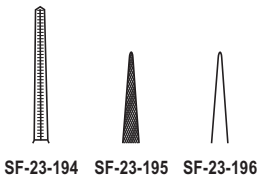

SF-23-194 SF-23-195 SF-23-196

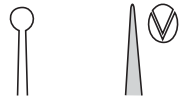

SF-23-197 SF-23-198

SF-23-194 - SF-23-198
15, 18, 21 cm

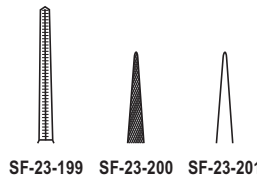
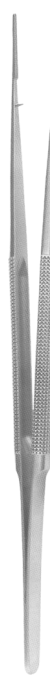

SF-23-199 SF-23-200 SF-23-201



SF-23-202 SF-23-203

SF-23-199 - SF-23-203
Forceps
15, 18, 21 cm

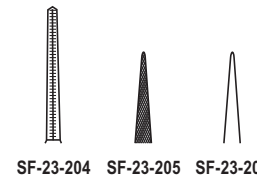

SF-23-204 SF-23-205 SF-23-206

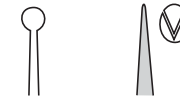

SF-23-207 SF-23-208

SF-23-204 - SF-23-208
Forceps
15, 18, 21 cm

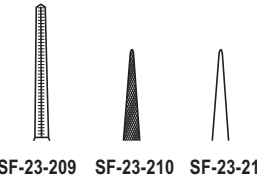

SF-23-209 SF-23-210 SF-23-211



SF-23-212 SF-23-213

SF-23-209 - SF-23-213
Forceps Counter
Balance
15, 18, 21 cm

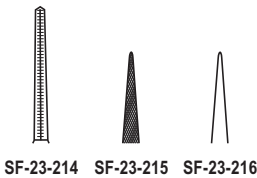

SF-23-214 SF-23-215 SF-23-216

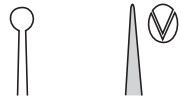

SF-23-217 SF-23-218

SF-23-214 - SF-23-218
Forceps Counter
Balance
15, 18, 21,
23, 25 cm

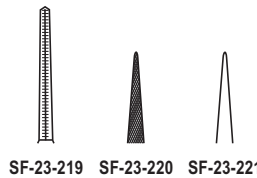

SF-23-219 SF-23-220 SF-23-221



SF-23-222 SF-23-223

SF-23-219 - SF-23-223
Forceps
15, 21, 23 cm

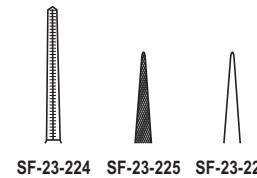

SF-23-224 SF-23-225 SF-23-226

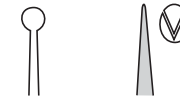

SF-23-227 SF-23-228

SF-23-224 - SF-23-228
Forceps
18, 21 cm

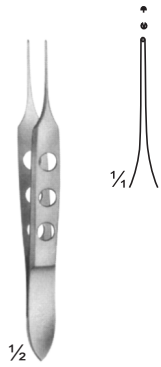

BISHOP-HARMON
SF-23-229
8.5 cm

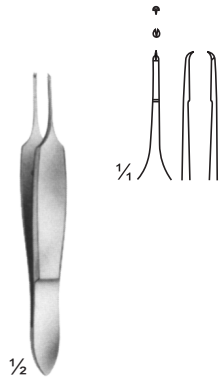

ST.MARTIN
SF-23-230
8 cm

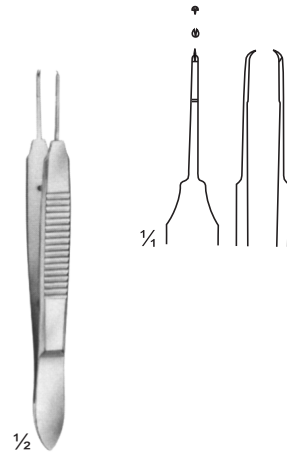

CASTROVIEJO
SF-23-231
teeth 0.9 mm
10 cm

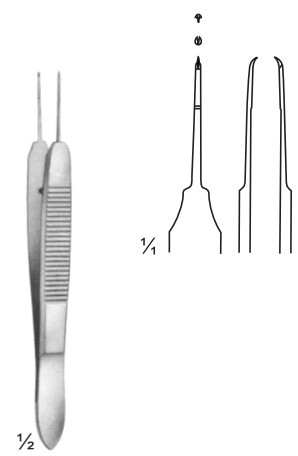

CASTROVIEJO
SF-23-232
teeth 0.5 mm
10 cm

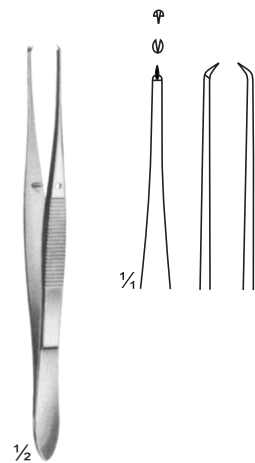

ELSCHING
SF-23-233
11 cm

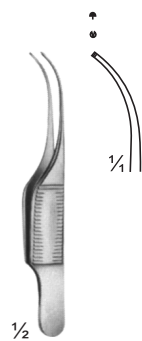

GILL
SF-23-234
7.5 cm

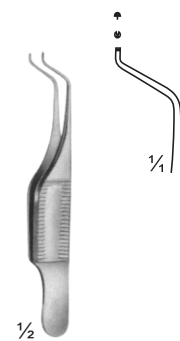

GILL - HESS
SF-23-235
7.5 cm

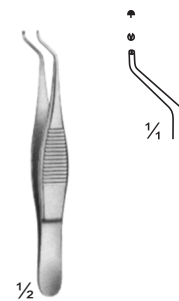

HESS
SF-23-236
7 cm

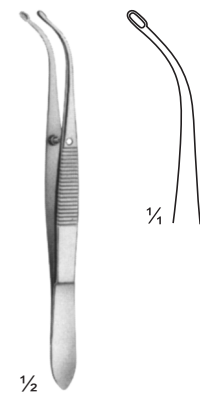

ARRUGA
SF-23-237
10 cm

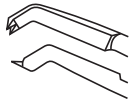

SF-23-238

SF-23-238
Colibri Forceps With
Tying Platform
8 cm

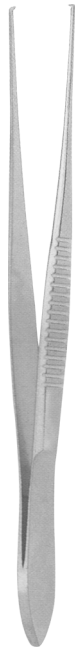

SF-23-239
Utility Forceps
10 cm

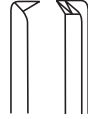
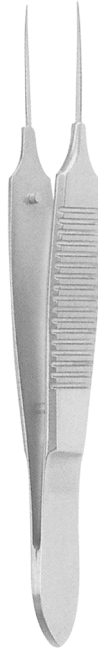

SF-23-240

SF-23-240 - 141
TUBINGEN
Suture Forceps
8.5, 11 cm

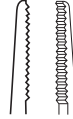

SF-23-241



SF-23-242
BONN
Suture Forceps
7.5 cm



SF-23-243
BONN
Iris Forceps
8 cm



SF-23-244
McDonalds-Spaleck
Lense Implantation
Forceps Crossaction
10 cm
5, 6 mm



SF-23-245
FAULKNER
Holding Forceps
10 cm
5, 6, 11 mm



SF-23-246
Spaleck-microma
Lense Implantation
Forceps
10 cm
5.6, 6.6 mm



SF-23-247
Hook



SF-23-248
JAMESON
Strabismus Hook

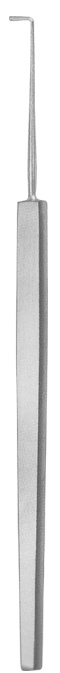

SF-23-249
GRAEFE
Strabismus Hook
13, 14 cm



SF-23-250
GRAEFE
Iris Hook



SF-23-251
GILLES
Skin Hook



SF-23-252
GUTHRIE
Fixation Hook,
double



SF-23-253
MEYHOFER
Spoon



SF-23-254
KUHNT
Corneal Scarifier



SF-23-255
GRAEFE
Scarifier



SF-23-256
Foreign Body
Needle



SF-23-257
HAMBURG
Air Keratome

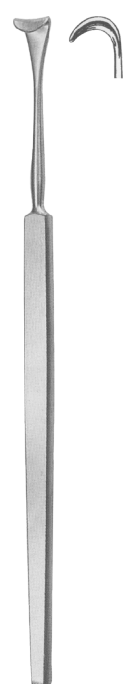

SF-23-258
DESMARRES
Eye Retractor



SF-23-259
BOWMAN
Lachrymal
Probes



SF-23-260
WILDER
Lachrymal
Probes



SF-23-261
WEISS
Eye Speculum



SF-23-262
CASTROVIEJO
Eye Speculum

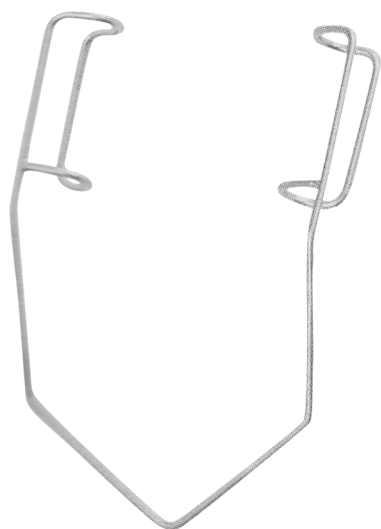

SF-23-263
BARRAQUER
Eye Speculum

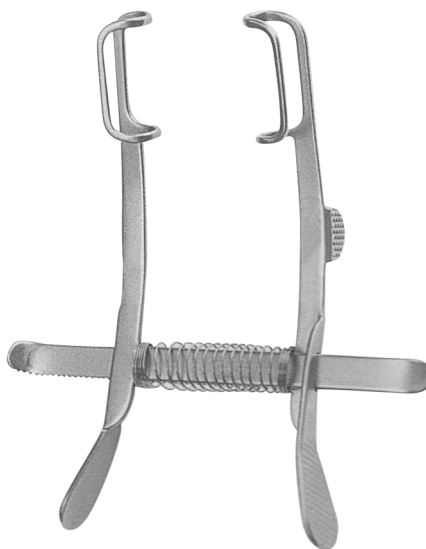

SF-23-264
MELLINGER
Eye Speculum

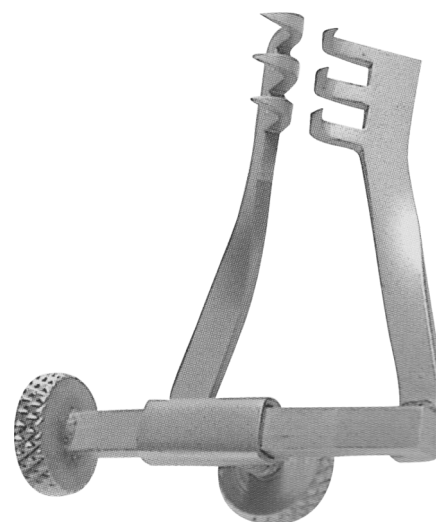

SF-23-265
MINIGOLDSTEIN
Self-Retaining Retractors
3 Teeth
2 cm

SELF RETAINING RETRACTORS

www.surgiforce.com

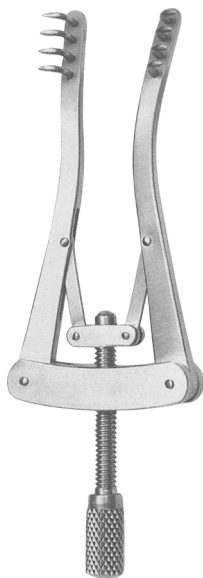

SF-23-266
ALM
Self-Retaining Retractors
4 Teeth
7 cm



SF-23-267
ALM
Self-Retaining Retractors
4 Teeth
10 cm



SF-23-268
HOLTZHEIMER
Self-Retaining Retractors
4 Teeth
10 cm



SF-23-269
HOLTZHEIMER
Self-Retaining Retractors
4 Teeth
10 cm

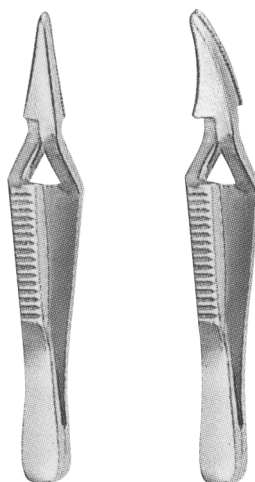

SF-23-270
Cross Action
Forceps
28 mm

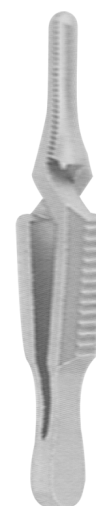

SF-23-271
Cross Action
Forceps
35 mm

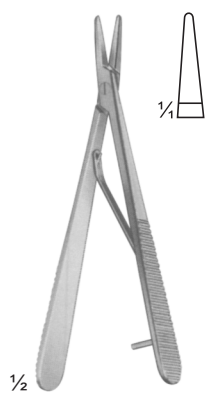

SF-23-272
ROHRSCHEIDER
With copper inserts
100 mm



SF-23-273
KALT
With catch
135 mm

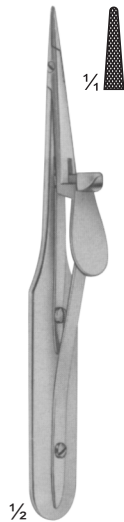

SF-23-274
ARRUGA
With catch
135 mm



SF-23-275 - 176
CASTROVIEJO
With catch
145 mm



SF-23-277 - 178
CASTROVIEJO
Without Catch
160 mm

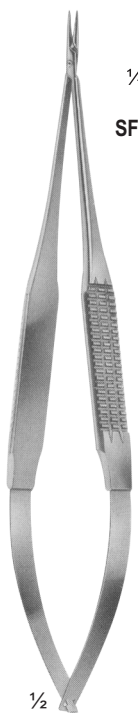

$\frac{1}{4}$
SF-23-279

$\frac{1}{4}$
SF-23-280

SF-23-279 - SF-23-280
Without catch
185 mm

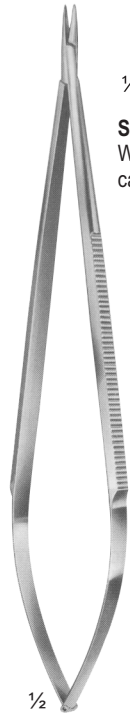

$\frac{1}{4}$
SF-23-281
Without
catch

$\frac{1}{4}$
SF-23-282
With catch

SF-23-281 - SF-23-282
JACOBSON
185 mm



SF-23-283
Without catch
195 mm

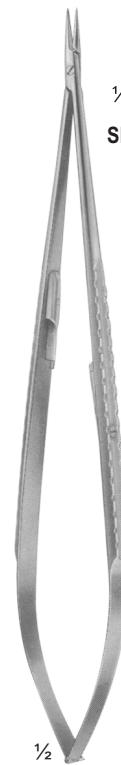

$\frac{1}{4}$ SF-23-284 $\frac{1}{4}$ SF-23-285

SF-23-284 - SF-23-285
YASARGIL
With catch
200 mm



SF-23-286 - SF-23-287
BARRAQUER
Without catch



SF-23-286
115 mm



SF-23-287
135 mm



SF-23-288 - SF-23-289
BARRAQUER
Without catch
120 mm



SF-23-288



SF-23-289



SF-23-290 - SF-23-291
BARRAQUER
Without catch
120 mm



SF-23-290



SF-23-291



SF-23-292 - SF-23-293
BARRAQUER
Without Catch
150 mm



SF-23-292



SF-23-293

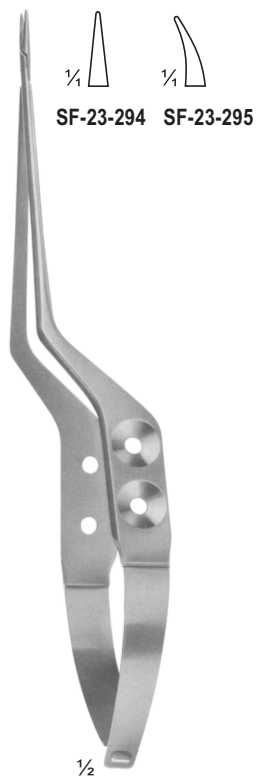

SF-23-294 - SF-23-295
YASARGIL
200 mm



SF-23-296 - SF-23-297
YASARGIL
225 mm



SF-23-298
YASARGIL
245 mm

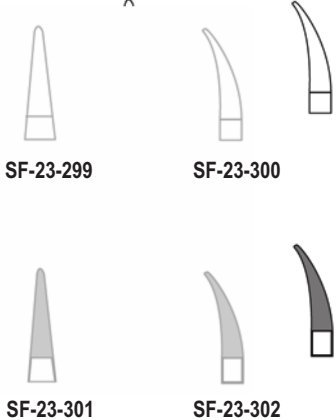

CASTROVIEJO
SF-23-299 - SF-23-302
145 mm

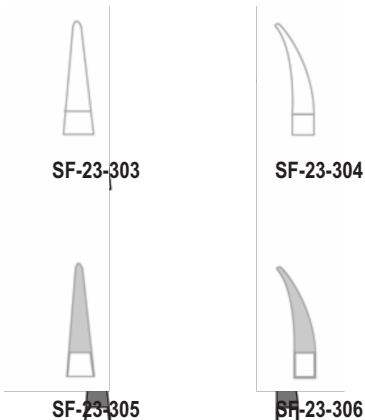

CASTROVIEJO
SF-23-303 - SF-23-306
180 mm

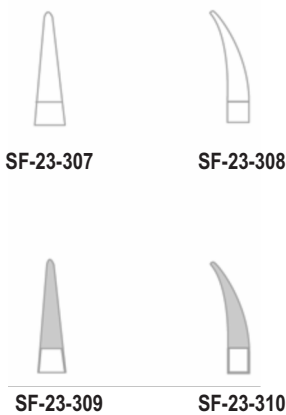

BARRAQUER
SF-23-307 - SF-23-310
145 mm

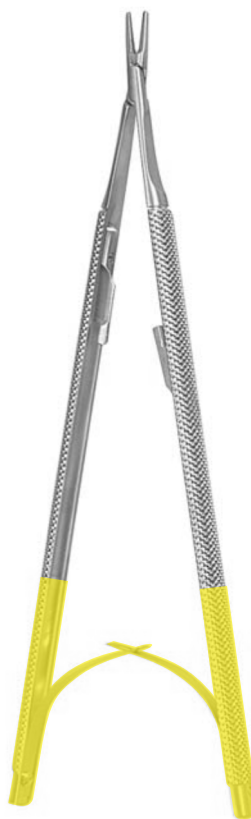

HEPP SCHEIDEL
SF-23-311
180 mm



Surgiforce Instruments



Opposite Surgical Association,
Malkay Kalan, Marala Road,
Sialkot-51050 Pakistan.



+92 523 559131



info@surgiforce.com
sales@surgiforce.com



www.surgiforce.com



Our Certifications:

ISO 9001

ISO 7151

CE Certified

ISO 17664:2004

EN 13485:2012

ISO 13402

ISO 7153-1

ISO 15223

