

Page  
407-463

- Mallets
- Tempers, Chisels, Gouges
- Bone Holding Forceps
- Rongeurs
- Bone Cutting Forceps
- Meniscus Instruments
- Wire Extension
- Hand Drills, Awls
- Reamers
- Bone Biopsy Instruments
- Finger Nail Instruments

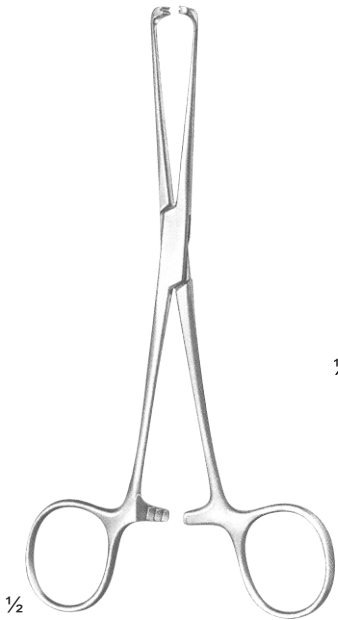

STEINMANN  
SF-19-101  
160 mm

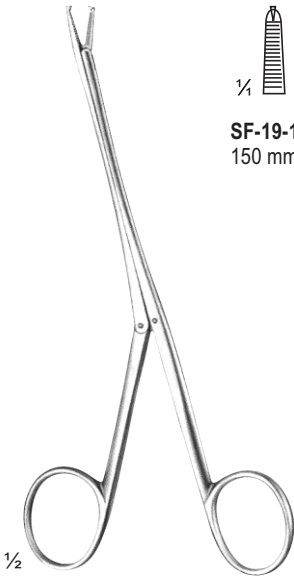
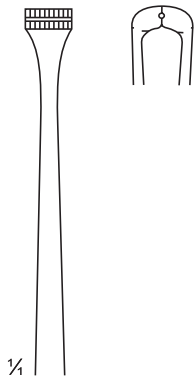

BRAND  
SF-19-102 - SF-19-104

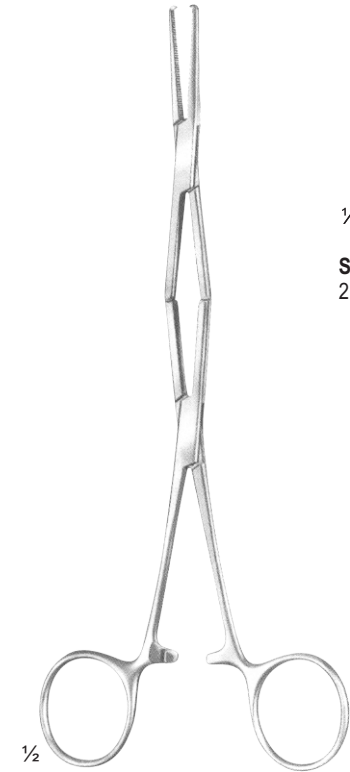
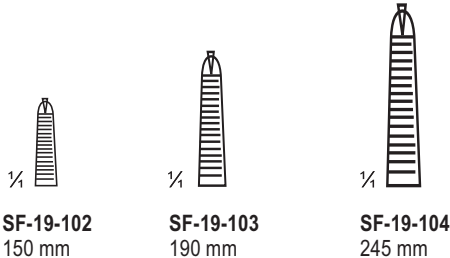

SF-19-105 - SF-19-106

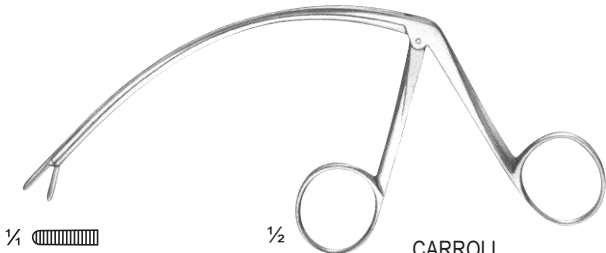
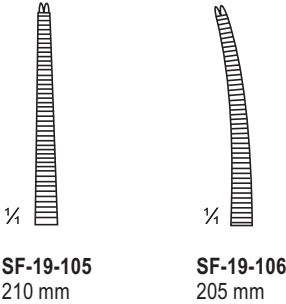

CARROLL  
SF-19-107  
115 mm

TENDON HOLDING FORCEPS, TENDON INTERLACING FORCEPS

[www.surgiforce.com](http://www.surgiforce.com)

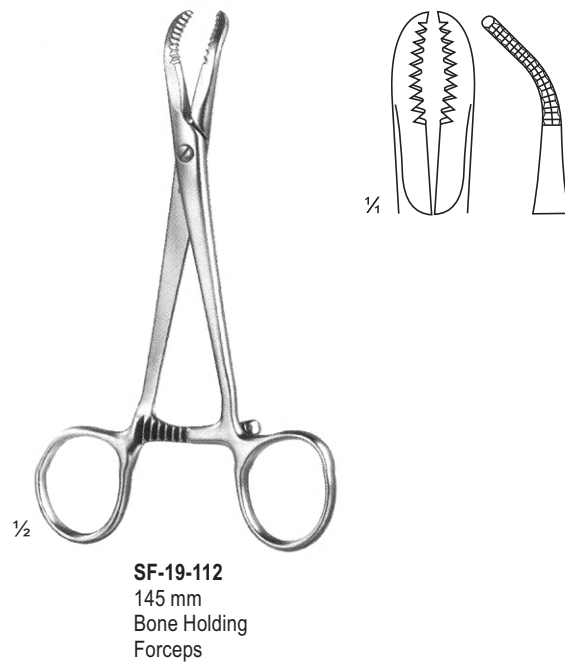
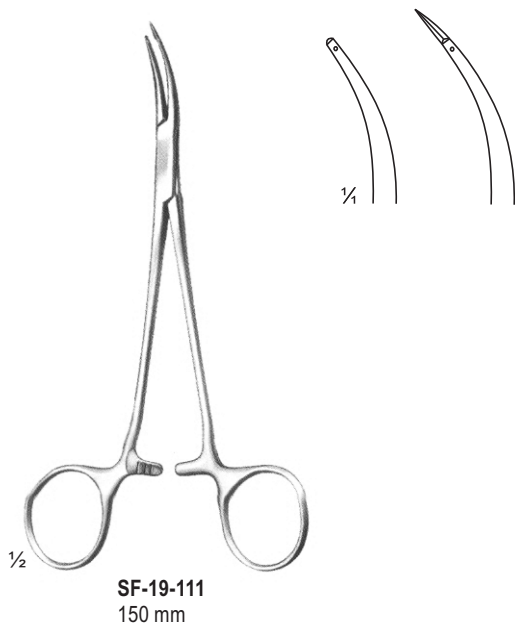
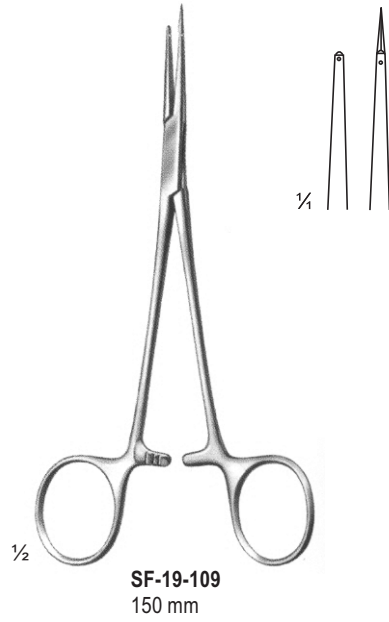
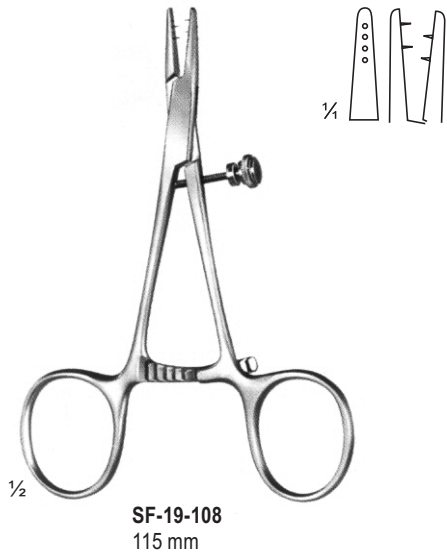



Repositioning forceps,  
for small fragments  
**SF-19-113**  
135 mm

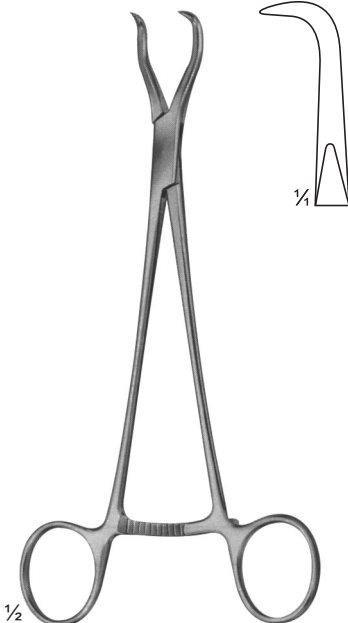

**HAASE**  
Repositioning forceps,  
for mandibular  
fractures  
**SF-19-114**  
165 mm

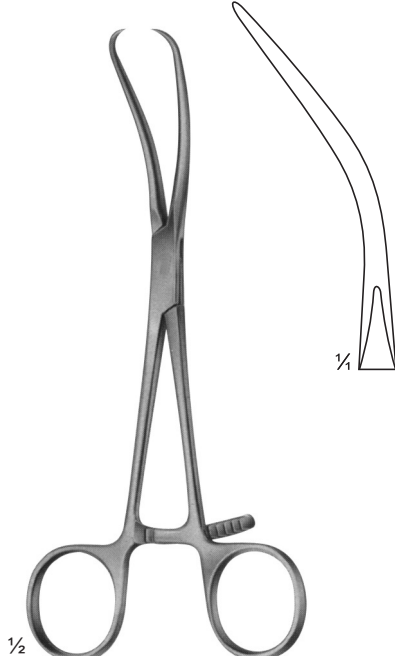

**REILL**  
Repositioning forceps,  
**SF-19-115**  
170 mm

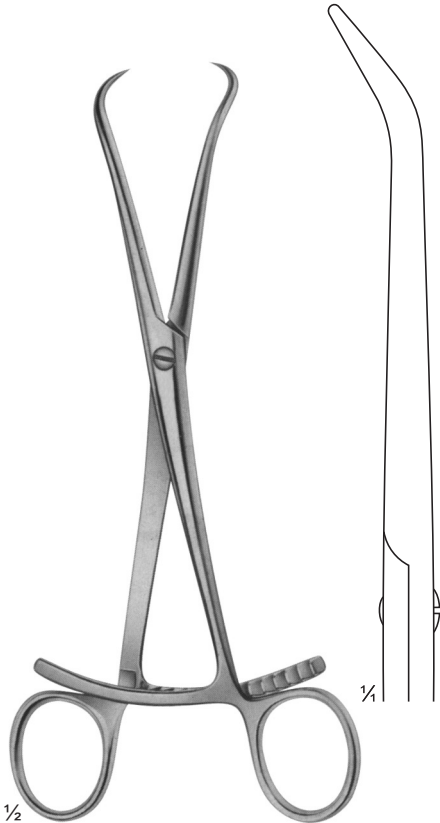

Repositioning forceps  
**SF-19-116**  
205 mm

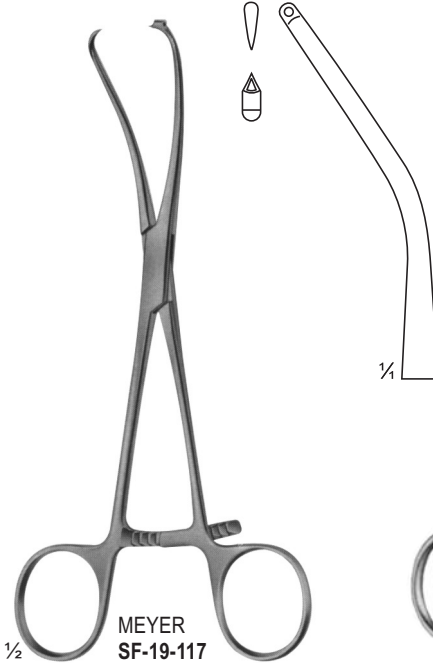

**MEYER**  
**SF-19-117**  
Repositioning forceps  
for fingers, with drill  
guide for **KIRSCHNER**  
wires up to daim.1.0 mm  
17 cm

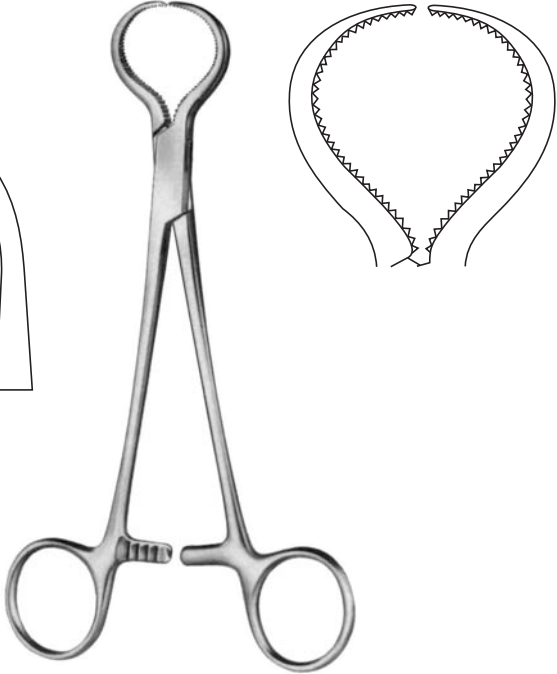

**LEWIN**  
**SF-19-118**  
180 mm



**PATELLA FORCEPS**  
**SF-19-119**  
185 mm

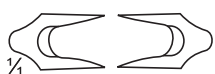

**Forceps with ratchet fixation**  
**SF-19-120**  
140 mm



**SF-19-121**  
120 mm

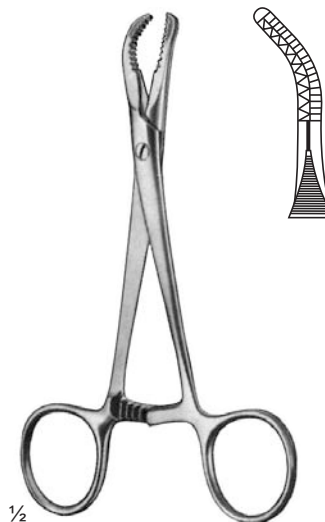

**SETTER**  
**SF-19-122**  
135 mm

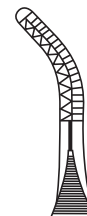

**SETTER**  
**SF-19-123**  
170 mm



**SETTER**  
**SF-19-124**  
235 mm

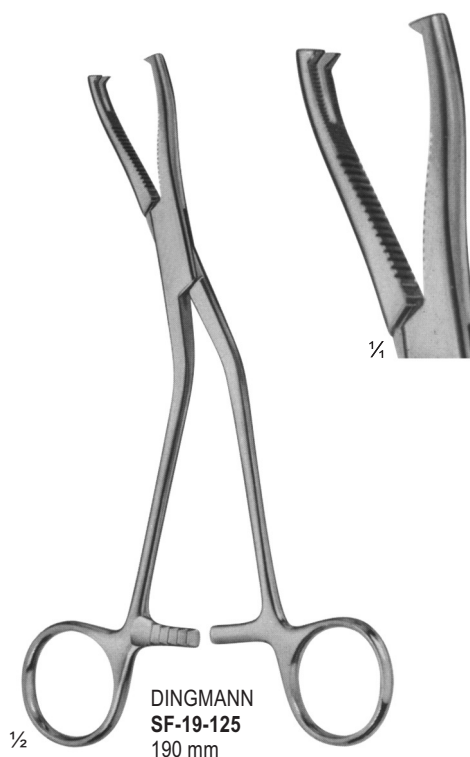

**DINGMANN**  
**SF-19-125**  
190 mm



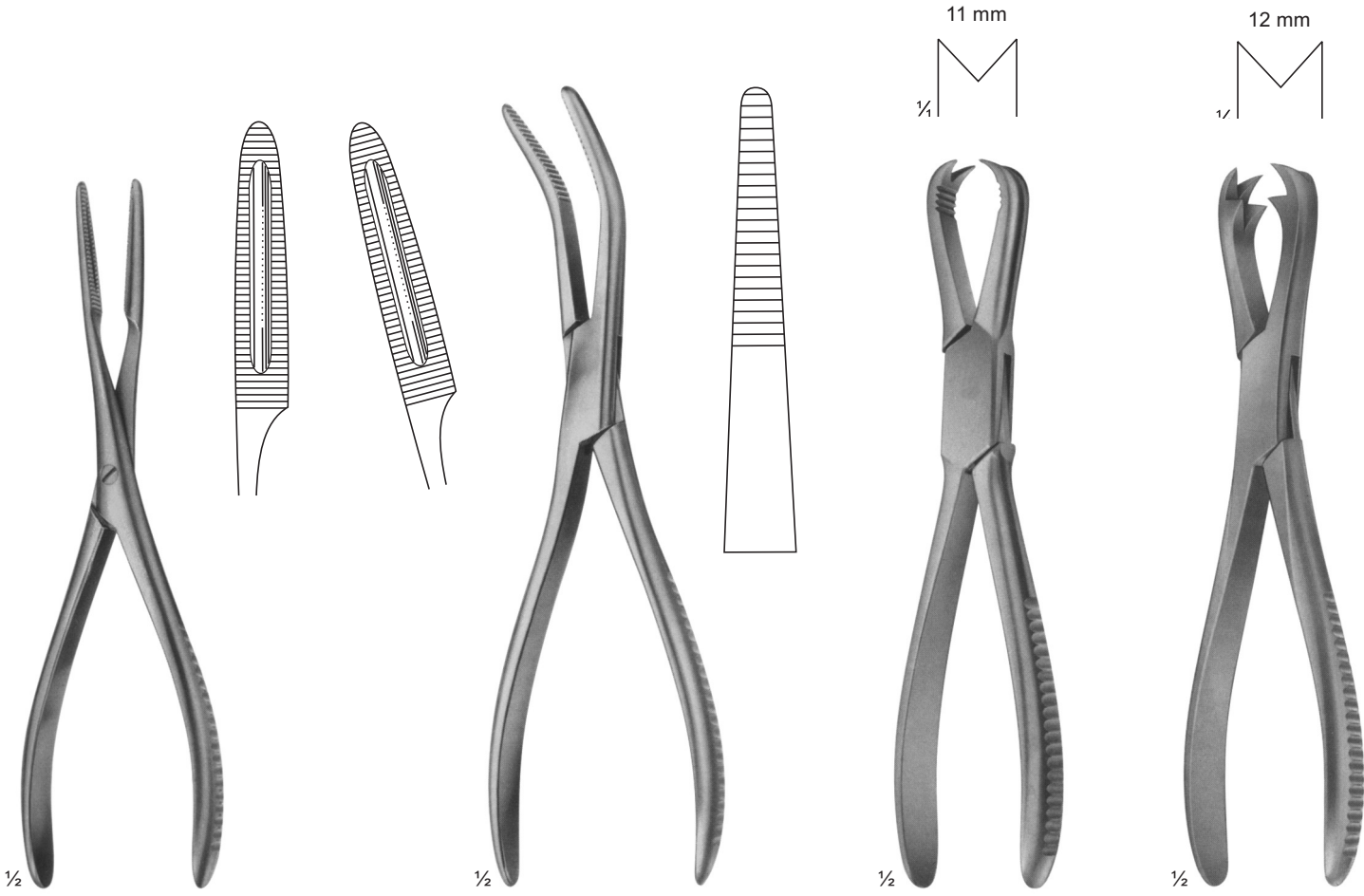

Sequestrum  
forceps  
**SF-19-126**  
200 mm

VAN BUREN  
Sequestrum  
forceps  
**SF-19-127**  
230 mm

LANGENBECK  
Sequestrum  
forceps  
**SF-19-128**  
205 mm

FERGUSON  
**SF-19-129**  
205 mm

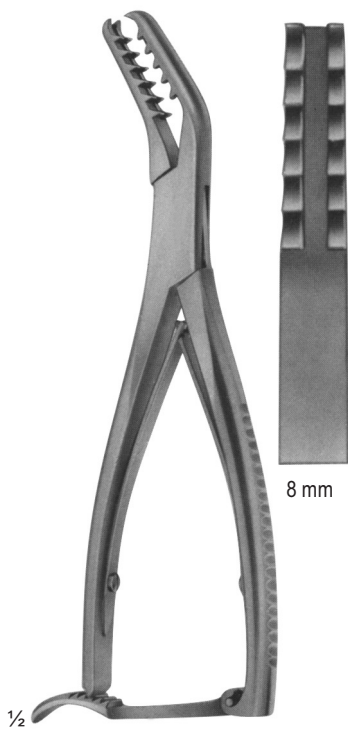

SEM B  
SF-19-130  
190 mm

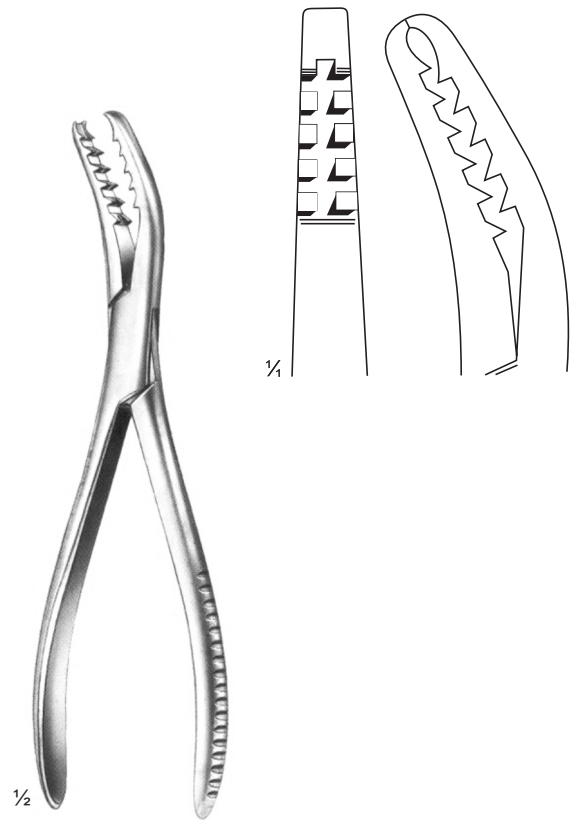
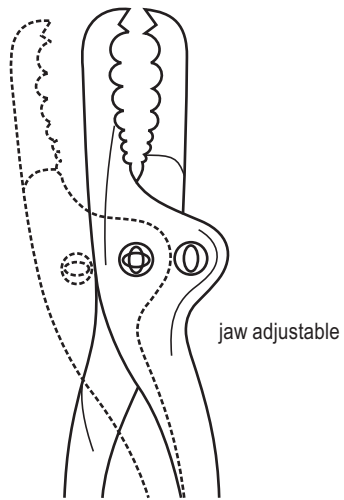

SEM B  
SF-19-131  
195 mm

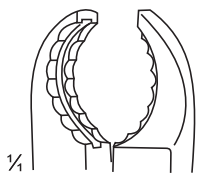
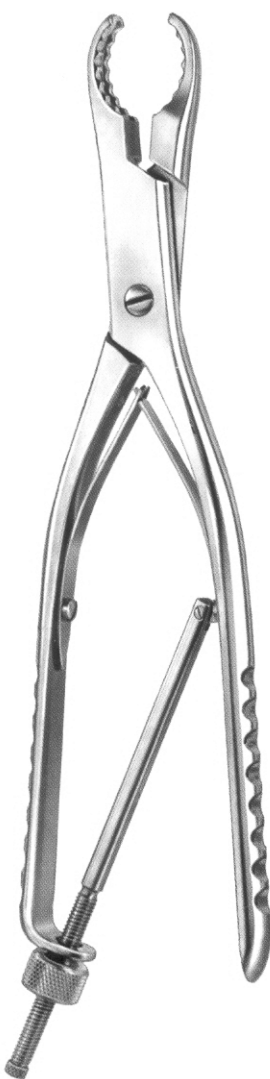
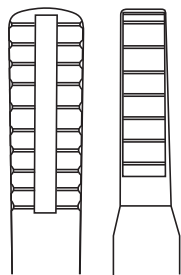
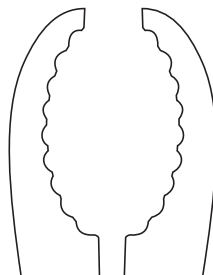
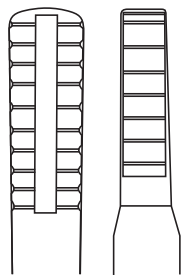
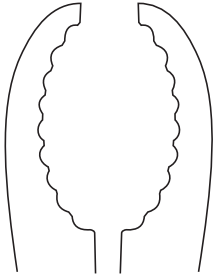

**SF-19-132**  
230 mm

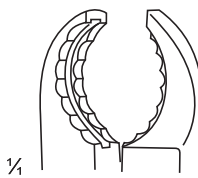

**SF-19-135**  
230 mm

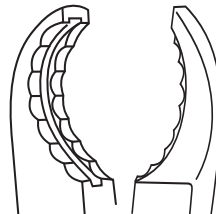

**SF-19-133**  
250 mm

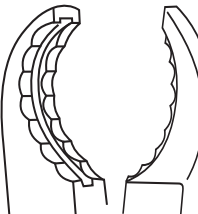

**SF-19-136**  
250 mm

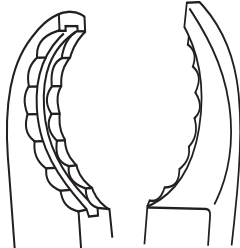

**SF-19-134**  
280 mm

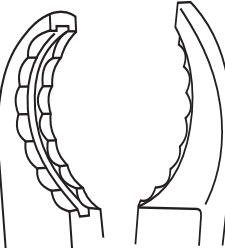

**SF-19-137**  
270 mm

$\frac{1}{2}$   
**ULRICH**  
**SF-19-132 - SF-19-134**  
With thread Fixation

$\frac{1}{2}$   
**ULRICH**  
**SF-19-135 - SF-19-137**  
With thread Fixation





**FARABEUF**  
**SF-19-138**  
230 mm



**FARABEUF**  
**SF-19-139**  
255 mm



**FARABEUF-LAMBOTTE**  
**SF-19-140**  
255 mm

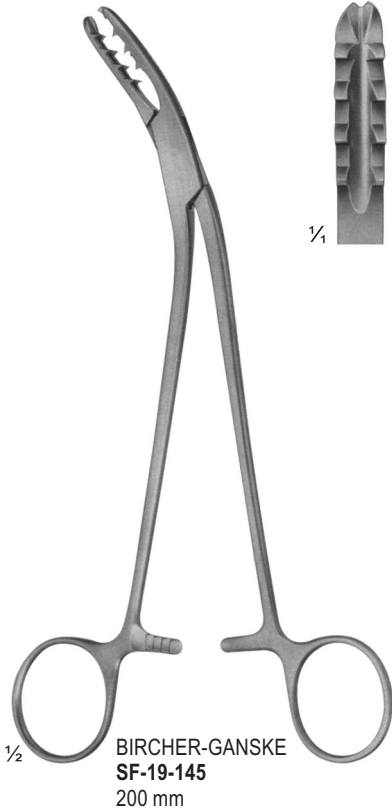
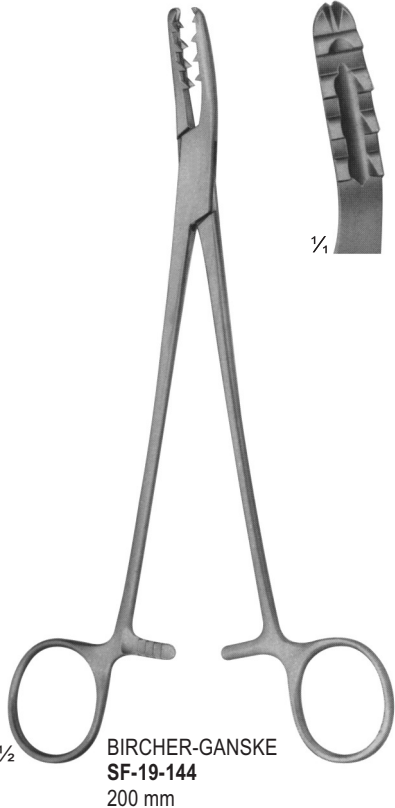
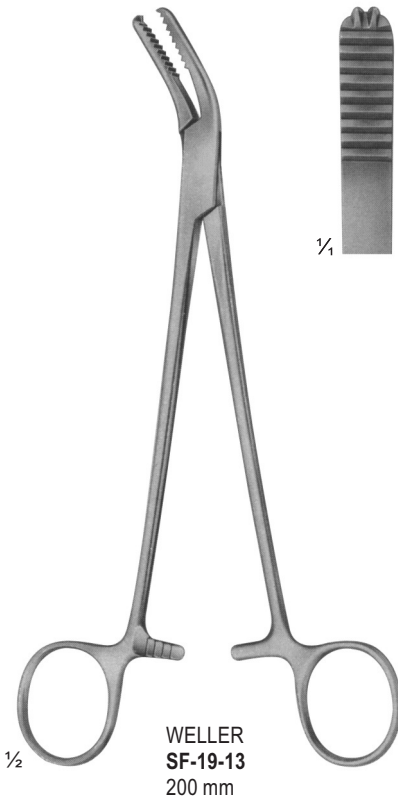
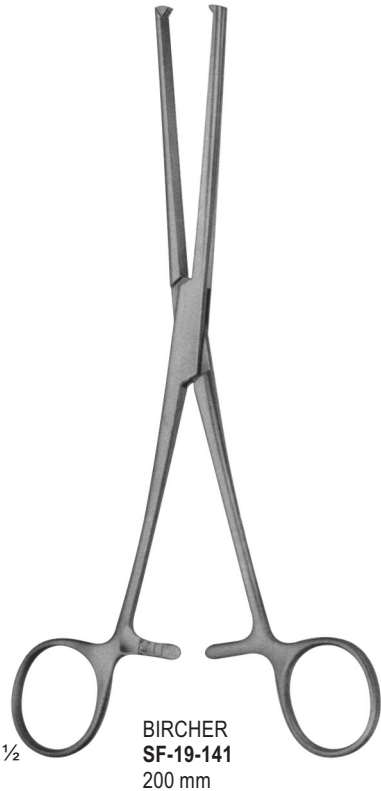

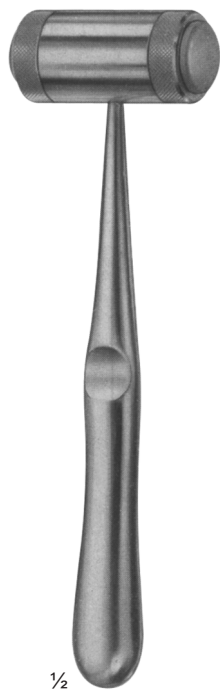

∅ 20 mm

1/2

**SF-19-147**  
**MEAD**  
 185 g  
 with interchangeable  
 plastic disks  
 190 mm  
 pair of spare disks

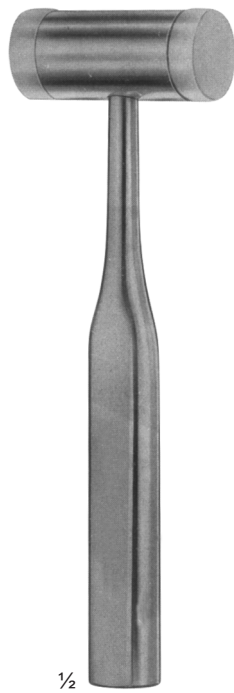

1/2

**SF-19-148**  
 140 g  
 with interchangeable  
 plastic disks  
 185 mm  
**SF-19-149**  
 pair of spare disks



∅ 25 mm

1/2

**SF-19-150**  
**COTTLE**  
 140 g  
 1 Seite convex  
 1 Side convex  
 185 mm



∅ 22 mm

1/2

**SF-19-151**  
 165 g  
 lead filled head  
 190 mm



HAJEK  
140 g  
SF-19-152  
215 mm



ST-053  
215 g  
with interchangeable  
plastic disks  
245 mm  
ST-054  
pair of spare disks

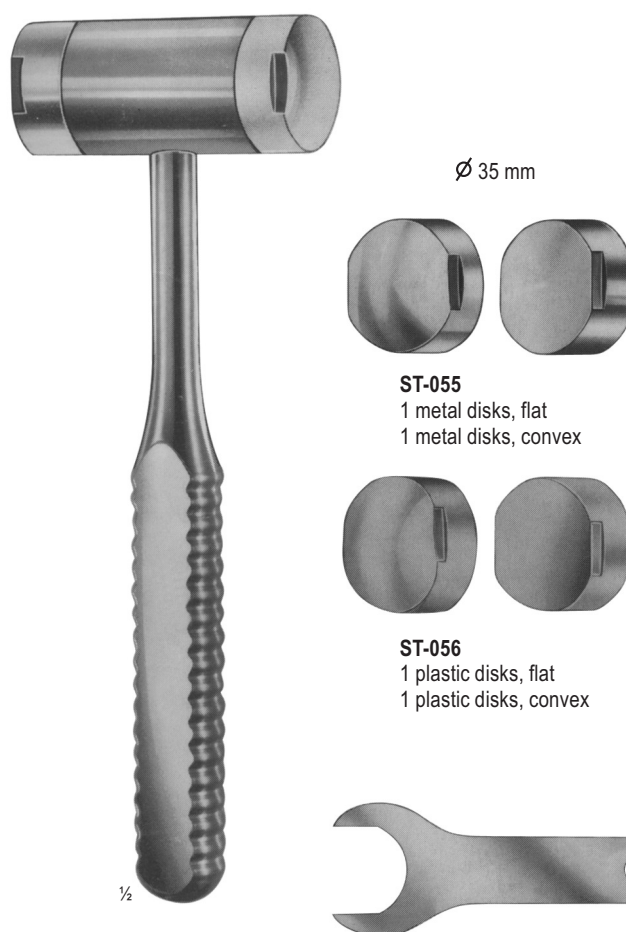

WAGNER  
complete with:  
1 pair of metal disks and  
1 pair of plastic disks and  
1 wrench 566  
ST-055 - ST-057  
235 mm

Wrench  
ST-057  
  
Mallet without disks 130 g



BERGMANN  
SF-19-158  
245 mm



BERGMANN  
SF-19-159  
235 mm



OMBREDANNE  
SF-19-160  
240 mm

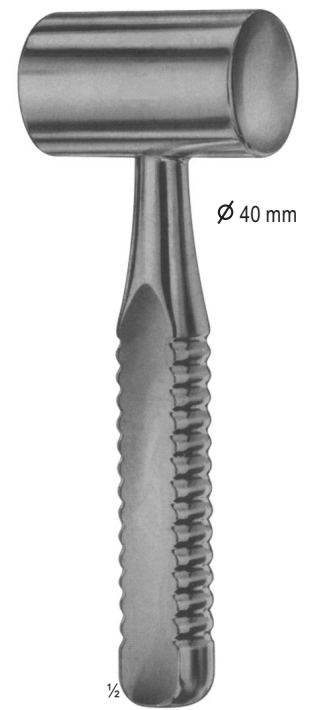

HEATH  
copper filled head  
700 g  
SF-19-161  
185 mm



**WILLIGER**  
**SF-19-162 - SF-19-164**  
Lead Filled

<b>SF-19-162</b>	
Weight	Head
275 g	∅ 26 mm
<b>SF-19-163</b>	
Weight	Head
320 g	∅ 28 mm
<b>SF-19-164</b>	
Weight	Head
340 g	∅ 30 mm



**DOYEN**  
**SF-19-165 - SF-19-167**

<b>SF-19-165</b>	
Weight	Head
120 g	∅ 25 mm
<b>SF-19-166</b>	
Weight	Head
180 g	∅ 30 mm
<b>SF-19-167</b>	
Weight	Head
260 g	∅ 35 mm



1/2

**PARTSCH**  
**SF-19-168**  
With Hollow Handle  
190 mm

Weight Head  
175 g Ø27 mm



**VIKERS**  
**SF-19-169**  
190 mm

Weight Head  
185 g Ø25 mm



**HERBERT**  
**SF-19-170**  
For Ulna Head Prosthesis  
190 mm

Weight Head  
215 g Ø25 mm



Fig. 000  
**SF-19-171**  
36 mm

Fig. 00  
**SF-19-172**  
44 mm

Fig. 0  
**SF-19-173**  
5.2 mm

CASPAR  
**SF-19-171 - SF-19-173**  
220 mm



Fig. 000  
**SF-19-174**  
3.6 mm

Fig. 00  
**SF-19-175**  
4.4 mm

Fig. 0  
**SF-19-176**  
5.2 mm

CASPAR  
**SF-19-174 - SF-19-176**  
220 mm



**SF-19-177**  
Ø 3 mm

**SF-19-178**  
Ø 5 mm

**SF-19-179**  
Ø 8 mm

CASPER  
**SF-19-177 - SF-19-179**  
200 mm



**SF-19-180**  
Ø 12 mm

**SF-19-181**  
Ø 14 mm

**SF-19-182**  
Ø 16 mm

CASPER  
**SF-19-180 - SF-19-182**  
200 mm



6 mm

**SF-19-183**

TESSIER  
**SF-19-183**  
220 mm



**SF-19-184**  
4 mm

**SF-19-185**  
5 mm

**SF-19-186**  
6 mm

CASPAR  
toothed  
**SF-19-184 - SF-19-186**  
220 mm



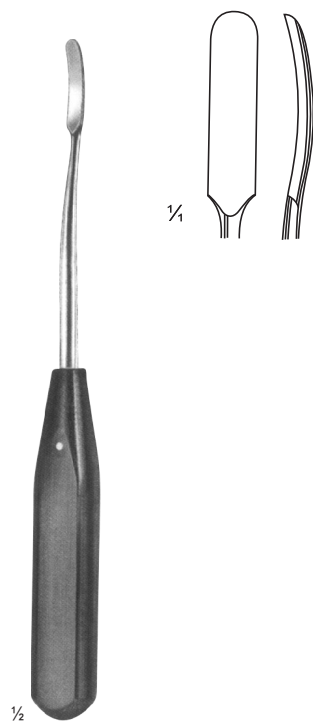

SF-19-187  
180 mm  
6 mm

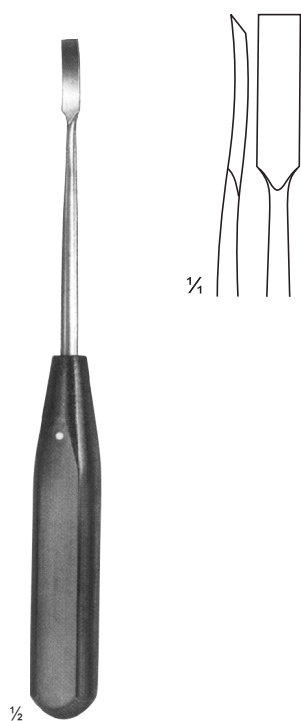

SF-19-188  
180 mm  
6 mm

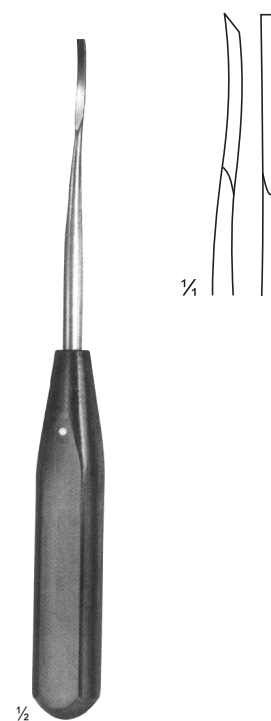

SF-19-189  
180 mm  
3 mm

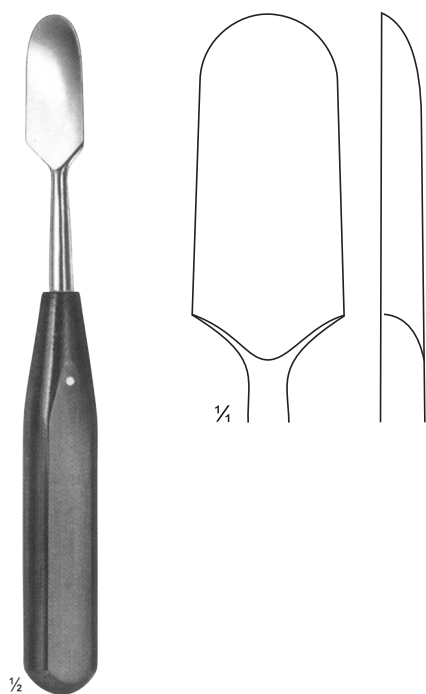

SF-19-190  
180 mm  
20 mm

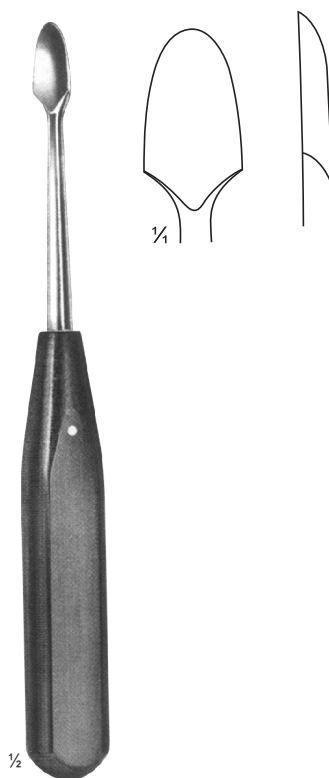

SF-19-191  
200 mm  
14 mm

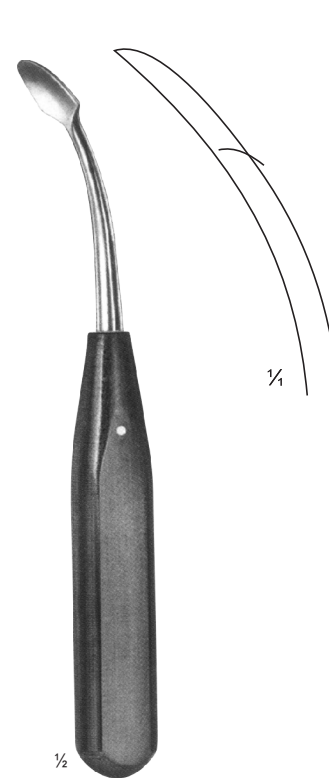

SF-19-192  
190 mm  
14 mm

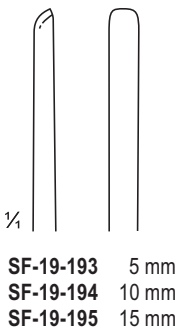

LEXER  
SF-19-193 - SF-19-195  
245 mm

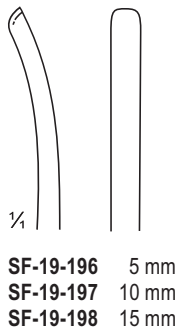

LEXER  
SF-19-196 - SF-19-198  
245 mm

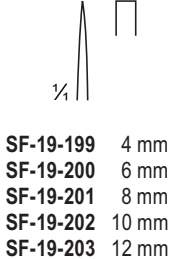

LEXER-MINI  
SF-19-199 - SF-19-203  
180 mm

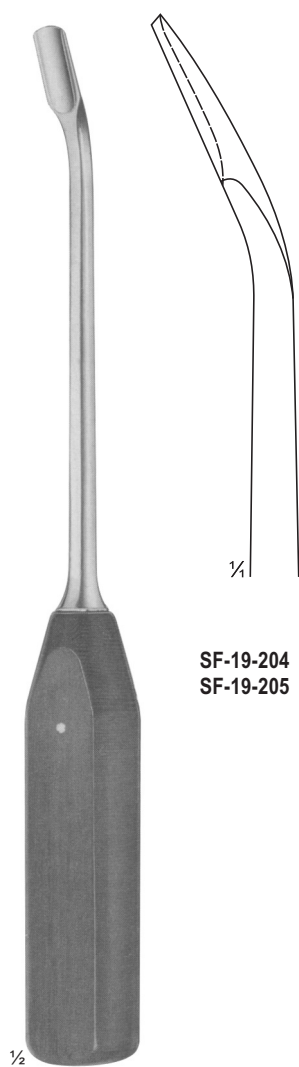

SF-19-204 10 mm  
SF-19-205 15 mm

LEXER  
SF-19-204 - SF-19-205  
Gouges,  
angled  
275 mm

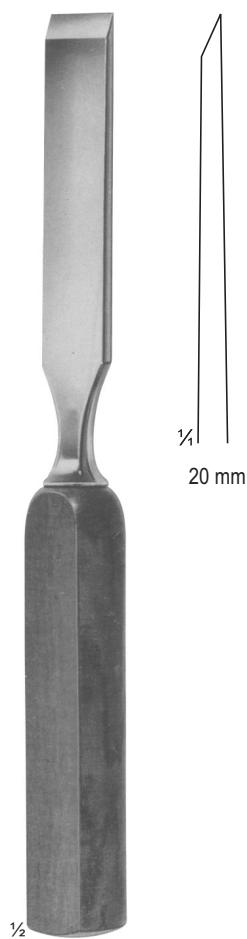

Chisel  
SF-19-206  
245 mm

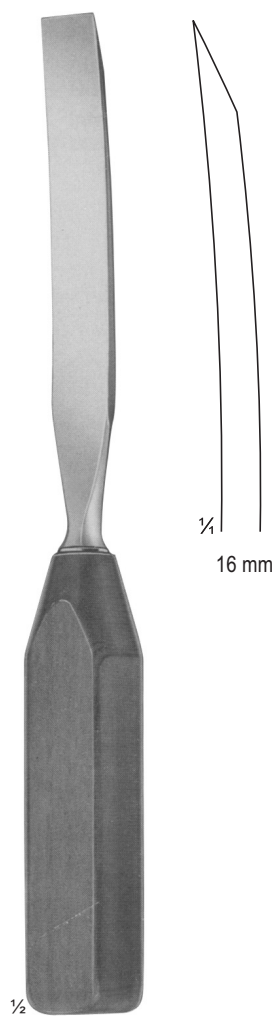

Chisel  
curved  
SF-19-207  
265 mm

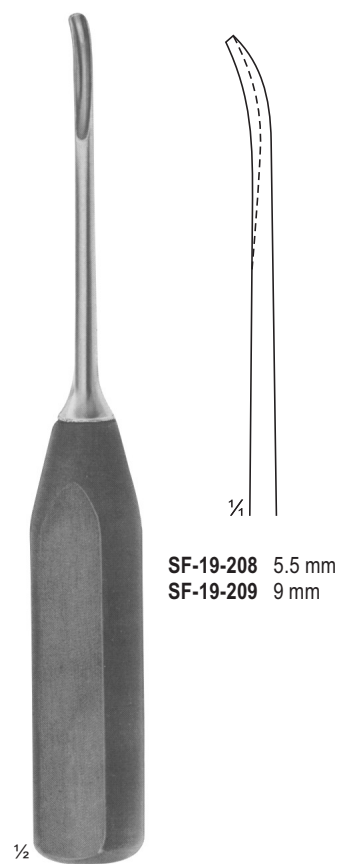

SF-19-208 5.5 mm  
SF-19-209 9 mm

ZIELKE  
SF-19-208 - SF-19-209  
Gouge for  
scoliose-operations  
230 mm



1/2

**SF-19-210 - SF-19-213**  
270 mm

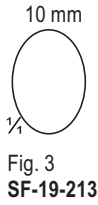
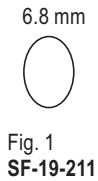
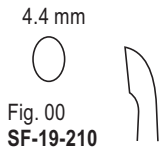

1/2

**SYPERT**  
**SF-19-214 - SF-19-221**  
380 mm

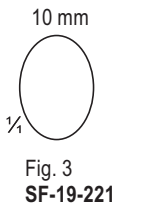
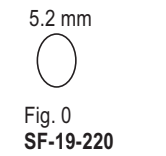
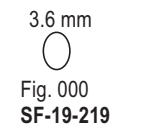
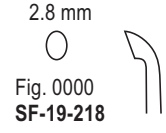
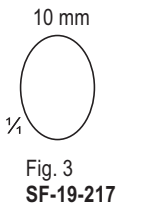
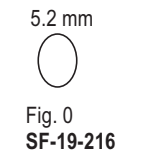
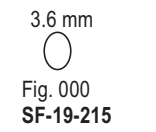
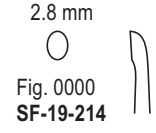



LANGENBECK  
SF-19-222 - SF-19-223



SF-19-222  
200 mm



SF-19-223  
200 mm



QUERVAIN  
SF-19-224  
200 mm

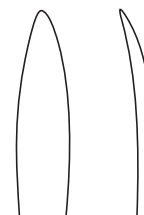

COBB  
SF-19-225 - SF-19-227



SF-19-225  
28 cm



SF-19-226  
280 mm



SF-19-227  
280 mm



SF-19-228 - SF-19-233  
SF-19-228 170 mm  
SF-19-229 170 mm  
SF-19-230 170 mm  
SF-19-231 170 mm  
SF-19-232 190 mm  
SF-19-233 190 mm



HOKE  
SF-19-234 - SF-19-238  
170 mm

- SF-19-234  
3 mm
- SF-19-235  
5 mm
- SF-19-236  
6 mm
- SF-19-237  
8 mm
- SF-19-238  
9 mm



HIBBS  
SF-19-239 - SF-19-243  
245 mm

- SF-19-239  
6 mm
- SF-19-240  
13 mm
- SF-19-241  
19 mm
- SF-19-242  
25 mm
- SF-19-243  
32 mm



HIBBS  
SF-19-244 - SF-19-248  
245 mm

- SF-19-244  
6 mm
- SF-19-245  
13 mm
- SF-19-246  
19 mm
- SF-19-247  
25 mm
- SF-19-248  
32 mm



SMITH-PETERSEN  
SF-19-249 - SF-19-255  
205 mm



- SF-19-249  
6 mm
- SF-19-250  
9 mm
- SF-19-251  
13 mm
- SF-19-252  
16 mm
- SF-19-253  
19 mm
- SF-19-254  
25 mm
- SF-19-255  
32 mm



SMITH-PETERSEN  
SF-19-256 - SF-19-262  
205 mm



- SF-19-256  
6 mm
- SF-19-257  
9 mm
- SF-19-258  
13 mm
- SF-19-259  
16 mm
- SF-19-260  
19 mm
- SF-19-261  
25 mm
- SF-19-262  
32 mm



SMITH-PETERSEN  
SF-19-263 - SF-19-266  
205 mm



- SF-19-263  
9 mm
- SF-19-264  
14 mm
- SF-19-265  
19 mm
- SF-19-266  
25 mm



SMITH-PETERSEN  
SF-19-267 - SF-19-270  
205 mm



- SF-19-267  
9 mm
- SF-19-268  
14 mm
- SF-19-269  
19 mm
- SF-19-270  
25 mm

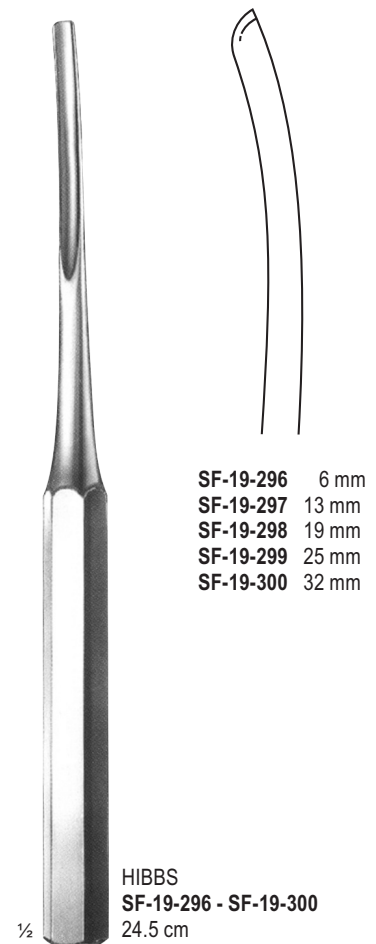
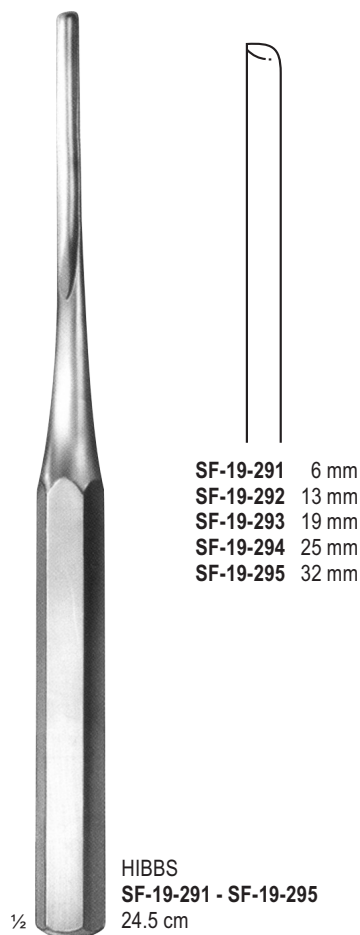
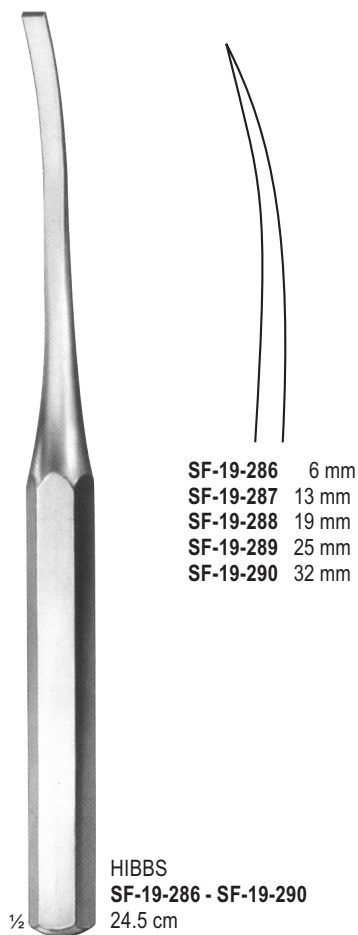
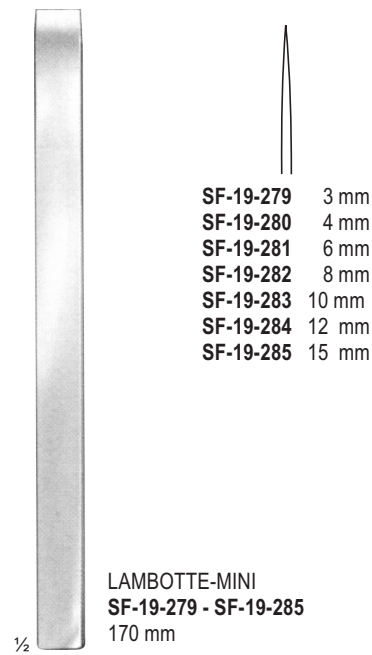
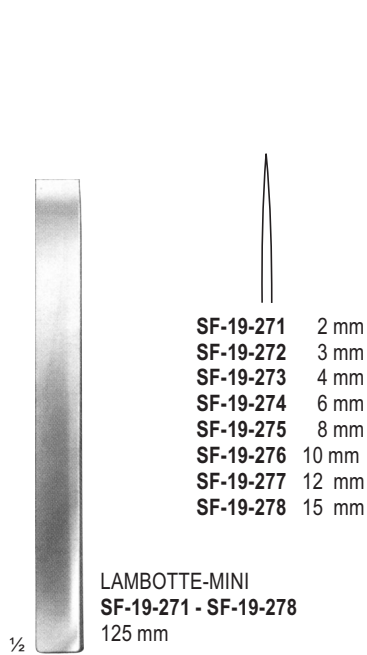



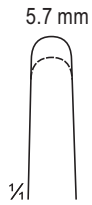

Haase  
SF-19-301  
100 mm



$\frac{1}{4}$  □  
SF-19-302  
5.7 mm  
 $\frac{1}{4}$  □  
SF-19-303  
3.5 mm

PASSOW  
SF-19-302 - SF-19-303  
120 mm



FREER  
Chisel  
SF-19-304  
160 mm



FREER  
Chisel, curved  
SF-19-305  
160 mm

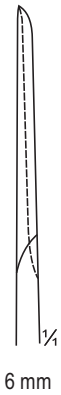

FREER  
Gouge  
SF-19-306  
150 mm



Scaphoid gouge,  
downwards curved  
SF-19-307  
135 mm



Scaphoid gouge,  
upwards curved  
SF-19-308  
135 mm



Mannerfelt  
SF-19-309 - SF-19-311  
SF-19-309 4 mm  
SF-19-310 6 mm  
SF-19-311 8 mm  
155 mm

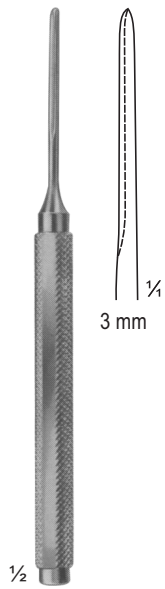

**SF-19-312**  
Mannerfelt  
155 mm

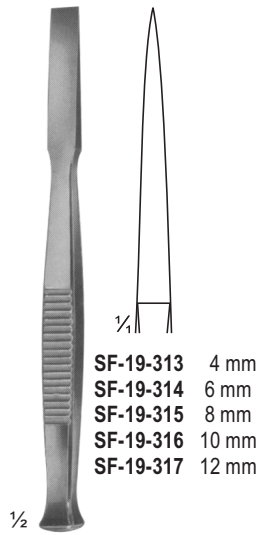

**SF-19-313 - SF-19-317**  
Osteotome  
140 mm

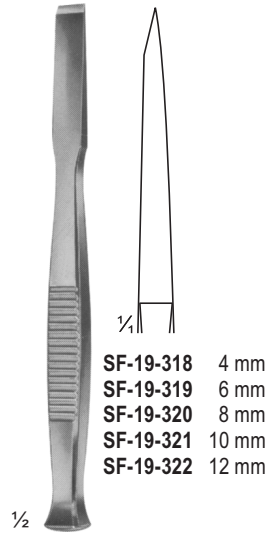

**SF-19-318 - SF-19-322**  
Chisels  
140 mm

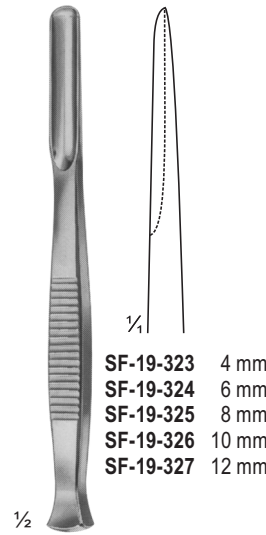

**SF-19-323 - SF-19-327**  
Gouges  
140 mm

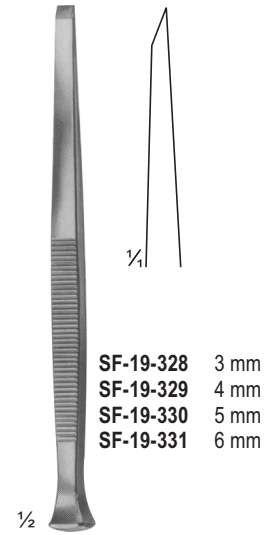

**PARTSCH**  
**SF-19-328 - SF-19-331**  
CHISELS  
140 mm

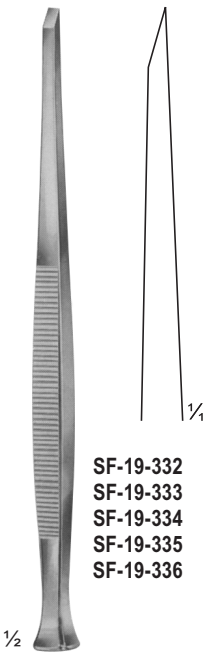

**PARTSCH**  
**SF-19-332 - SF-19-336**  
Chisels  
170 mm

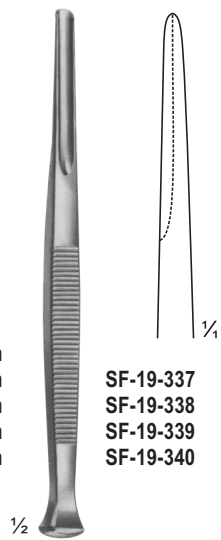

**PARTSCH**  
**SF-19-337 - SF-19-340**  
Gouges  
140 mm

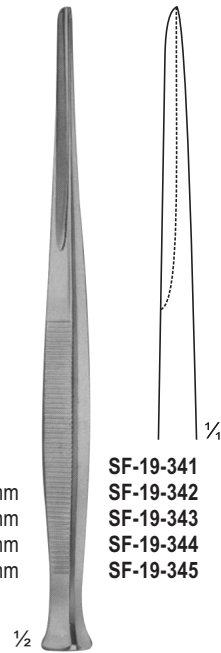

**PARTSCH**  
**SF-19-341 - SF-19-345**  
Gouges  
170 mm

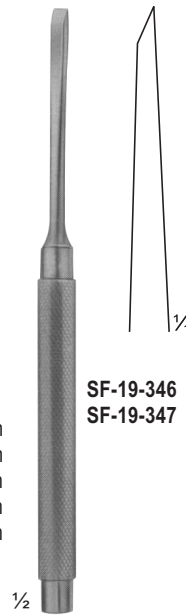

**LUCAS**  
**SF-19-346 - SF-19-347**  
Chisels  
160 mm

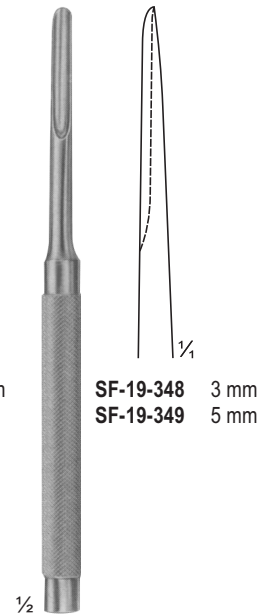

**LUCAS**  
**SF-19-348 - SF-19-349**  
Gouges  
160 mm

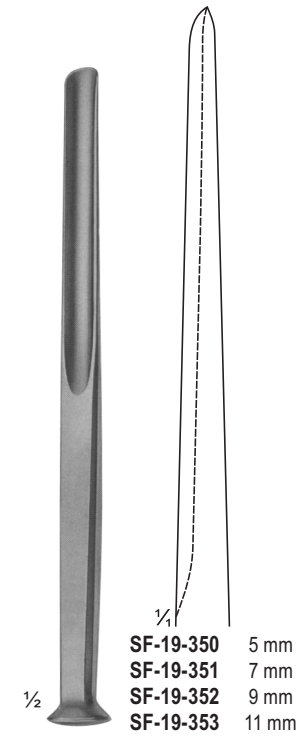

**ALEXANDER**  
SF-19-350 - SF-19-353  
Gouges  
170 mm

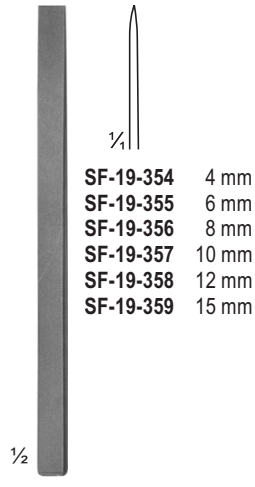

**LAMBOTTE**  
SF-19-354 - SF-19-359  
Osteotome  
125 mm

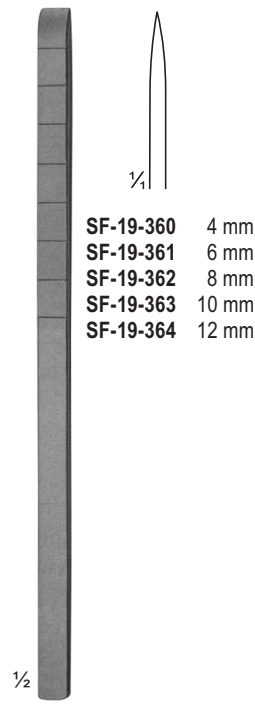

**COTTLE**  
SF-19-360 - SF-19-364  
Osteotome with depth markings  
180 mm

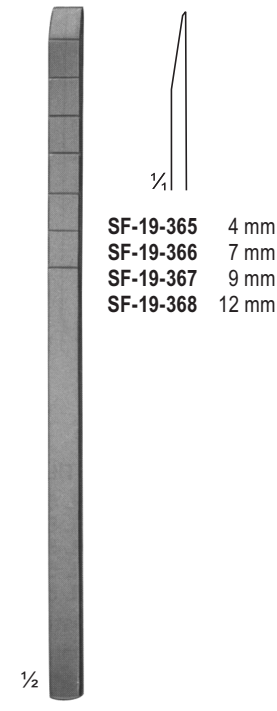

**COTTLE**  
SF-19-365 - SF-19-368  
Chisel-Osteotomes with depth markings  
180 mm

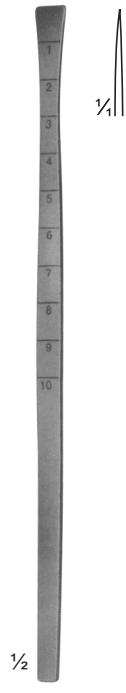

**COTTLE**  
SF-19-369  
Fishtail Chisel, with protected ends  
180 mm

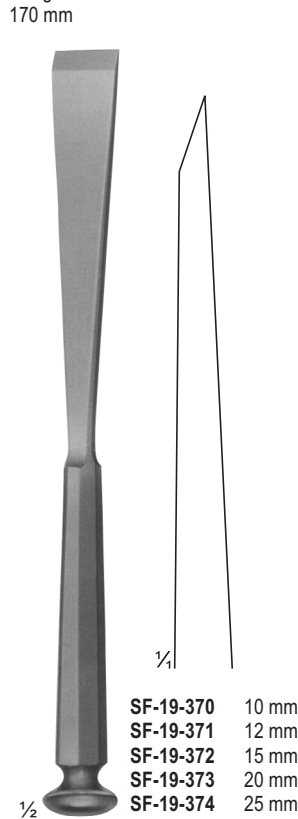

**STILLE**  
SF-19-370 - SF-19-374  
Chisels  
205 mm

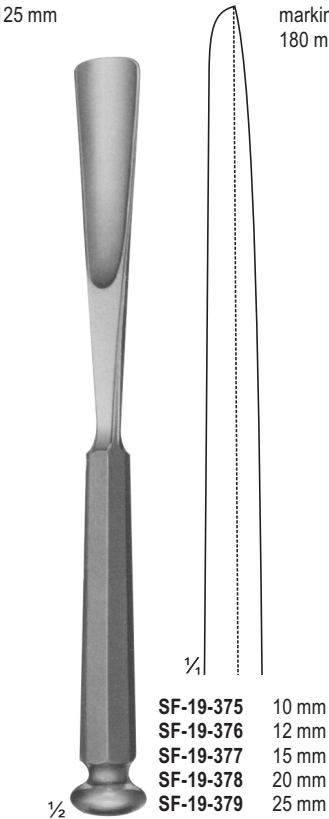

**STILLE**  
SF-19-375 - SF-19-379  
Gouges  
205 mm

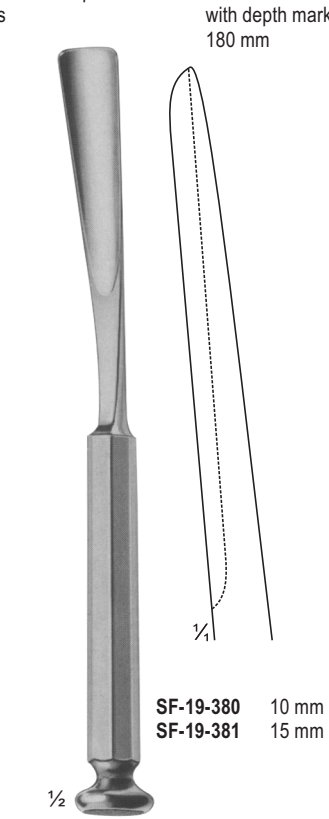

**WALTER**  
SF-19-380 - SF-19-381  
Osteotomes gouges for taking grafts from the rib  
205 mm

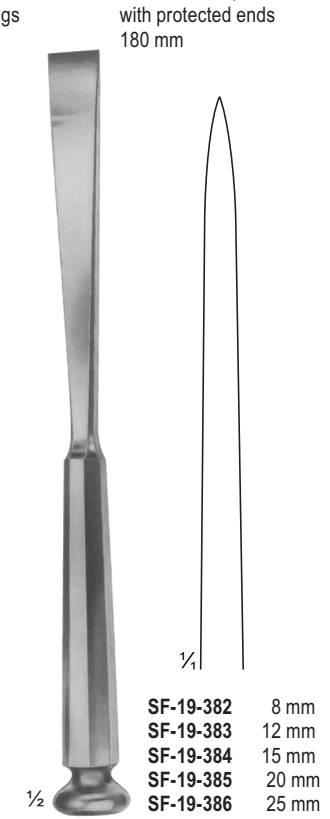

**STILLE**  
SF-19-382 - SF-19-386  
Osteotomes  
205 mm

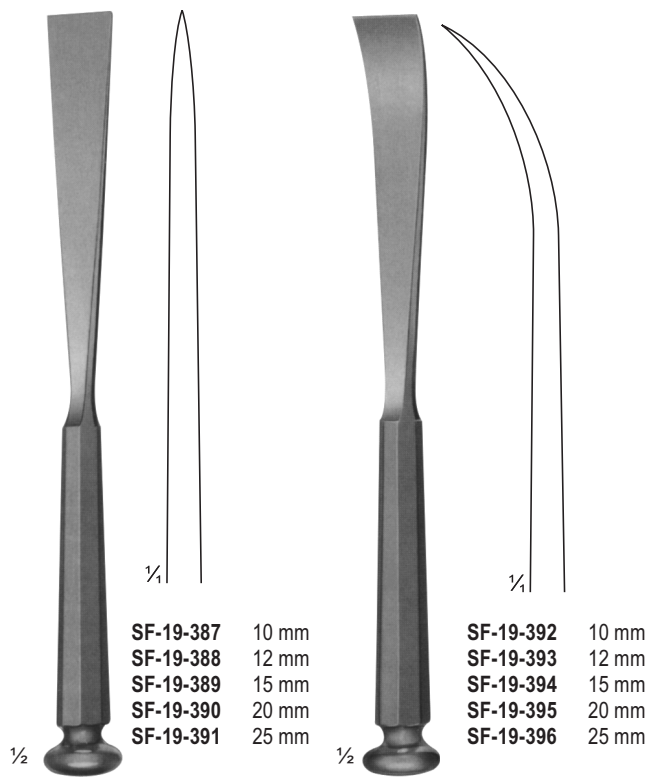

**STILLE**  
**SF-19-387 - SF-19-391**  
Osteotomes  
205 mm

**STILLE**  
**SF-19-392 - SF-19-396**  
Osteotomes, curved  
205 mm

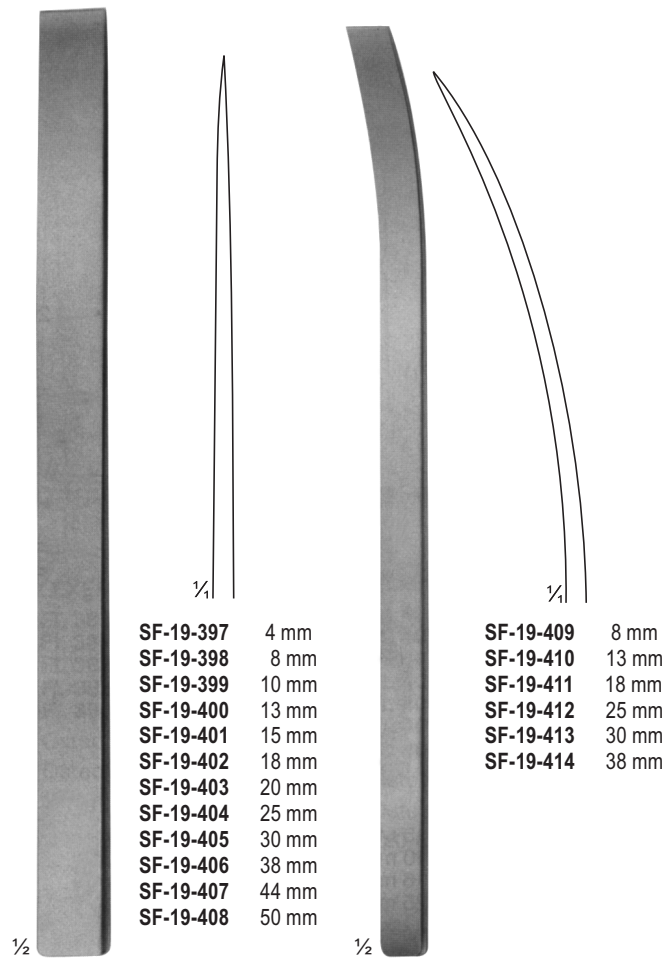

**LAMBOTTE**  
**SF-19-397 - SF-19-408**  
Osteotomes  
245 mm

**LAMBOTTE**  
**SF-19-409 - SF-19-414**  
Osteotomes, curved  
245 mm

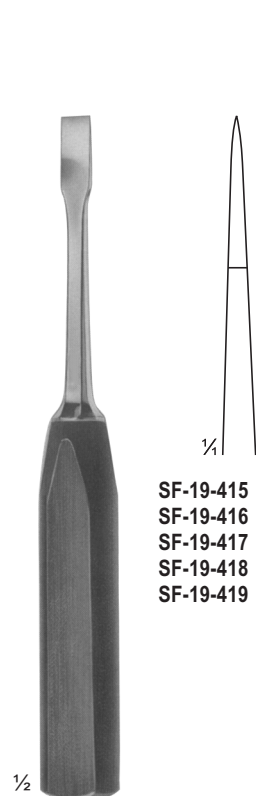

SF-19-415 4 mm  
 SF-19-416 6 mm  
 SF-19-417 8 mm  
 SF-19-418 10 mm  
 SF-19-419 12 mm

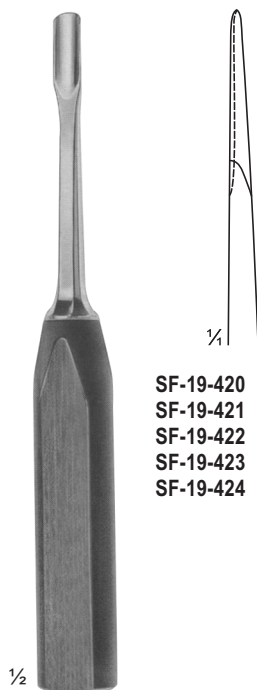

SF-19-420 4 mm  
 SF-19-421 6 mm  
 SF-19-422 8 mm  
 SF-19-423 10 mm  
 SF-19-424 12 mm

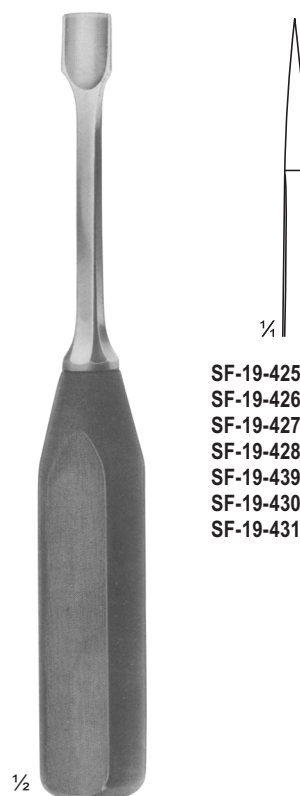

SF-19-425 5 mm  
 SF-19-426 7 mm  
 SF-19-427 10 mm  
 SF-19-428 15 mm  
 SF-19-439 20 mm  
 SF-19-430 25 mm  
 SF-19-431 30 mm

LEXER-MINI  
 SF-19-415 - SF-19-419  
 Osteotomes  
 180 mm



LEXER-MINI  
 SF-19-420 - SF-19-424  
 Gouges  
 180 mm

LEXER  
 SF-19-425 - SF-19-431  
 Osteotomes  
 220 mm



SF-19-432 5 mm  
 SF-19-433 7 mm  
 SF-19-434 10 mm  
 SF-19-435 15 mm  
 SF-19-436 20 mm  
 SF-19-437 25 mm  
 SF-19-438 30 mm

LEXER  
 SF-19-432 - SF-19-438  
 Gouges  
 220 mm

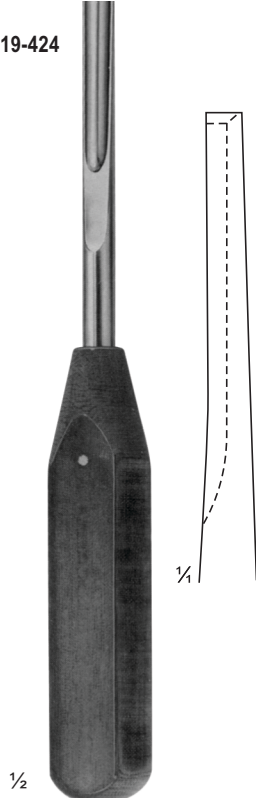

LEXER  
 SF-19-439  
 Gouge for  
 removing broken  
 screws  
 220 mm



SF-19-440 5,5 mm  
 SF-19-441 9,0 mm

ZIELKE  
 SF-19-440 - SF-19-441  
 Gouge for  
 scoliose-operations  
 230 mm

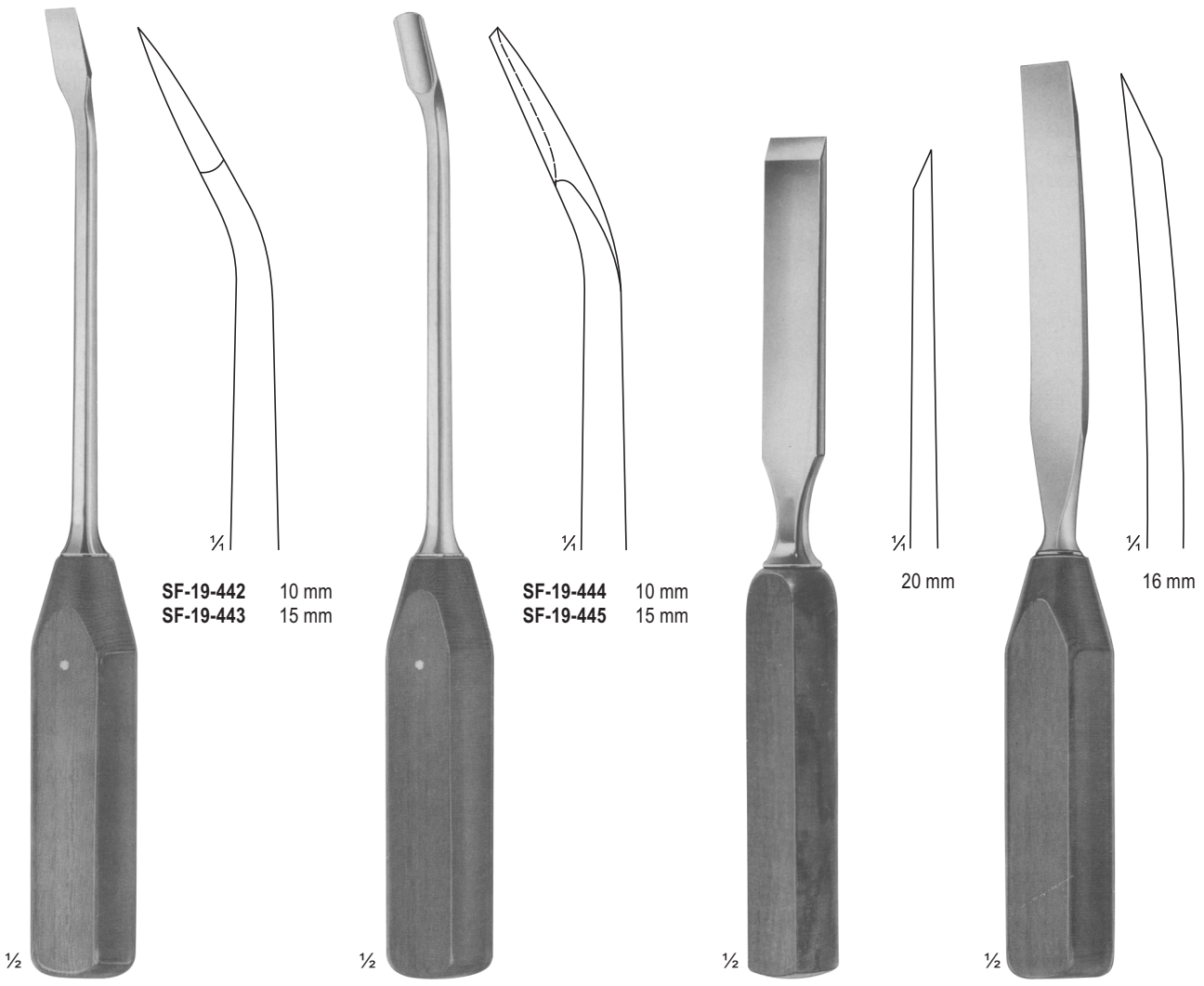

**SF-19-442** 10 mm  
**SF-19-443** 15 mm

**SF-19-444** 10 mm  
**SF-19-445** 15 mm

20 mm

16 mm

LEXER  
**SF-19-442 - SF-19-443**  
Osteotomes,  
angled  
275 mm

LEXER  
**SF-19-444 - SF-19-445**  
Gouges,  
angled  
275 mm

**SF-19-446**  
Chisel  
245 mm

**SF-19-447**  
Chisel, curved  
265 mm

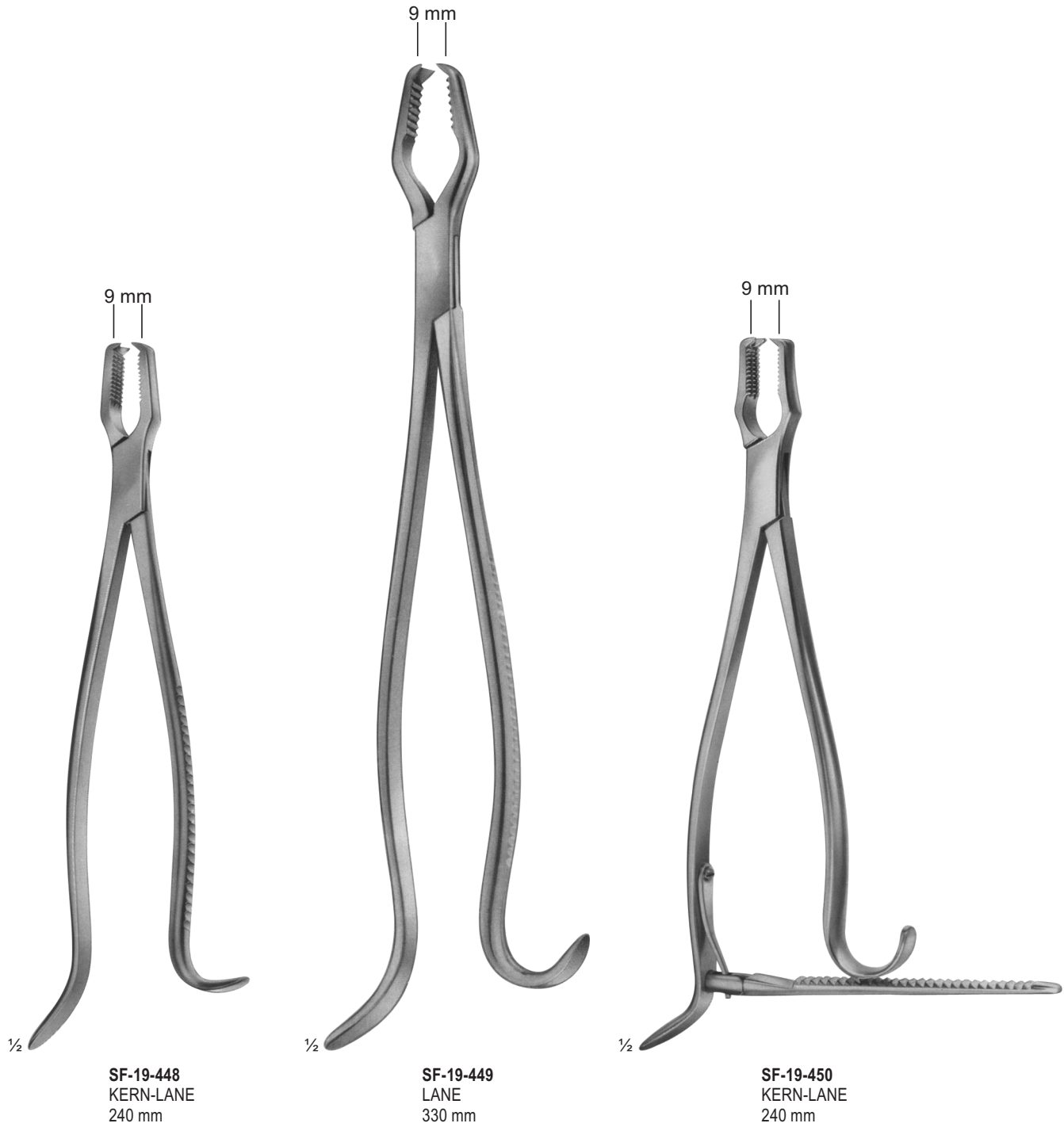

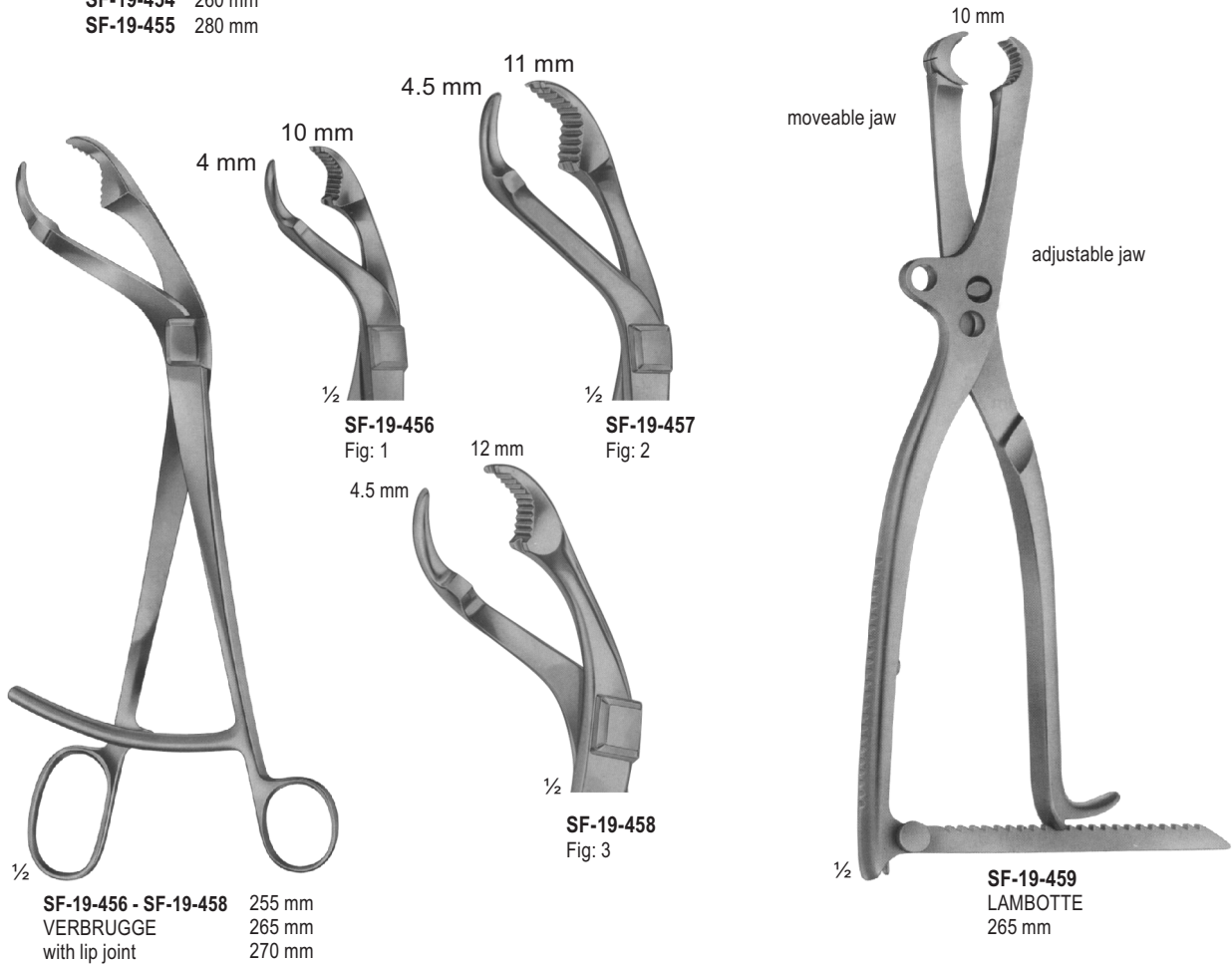
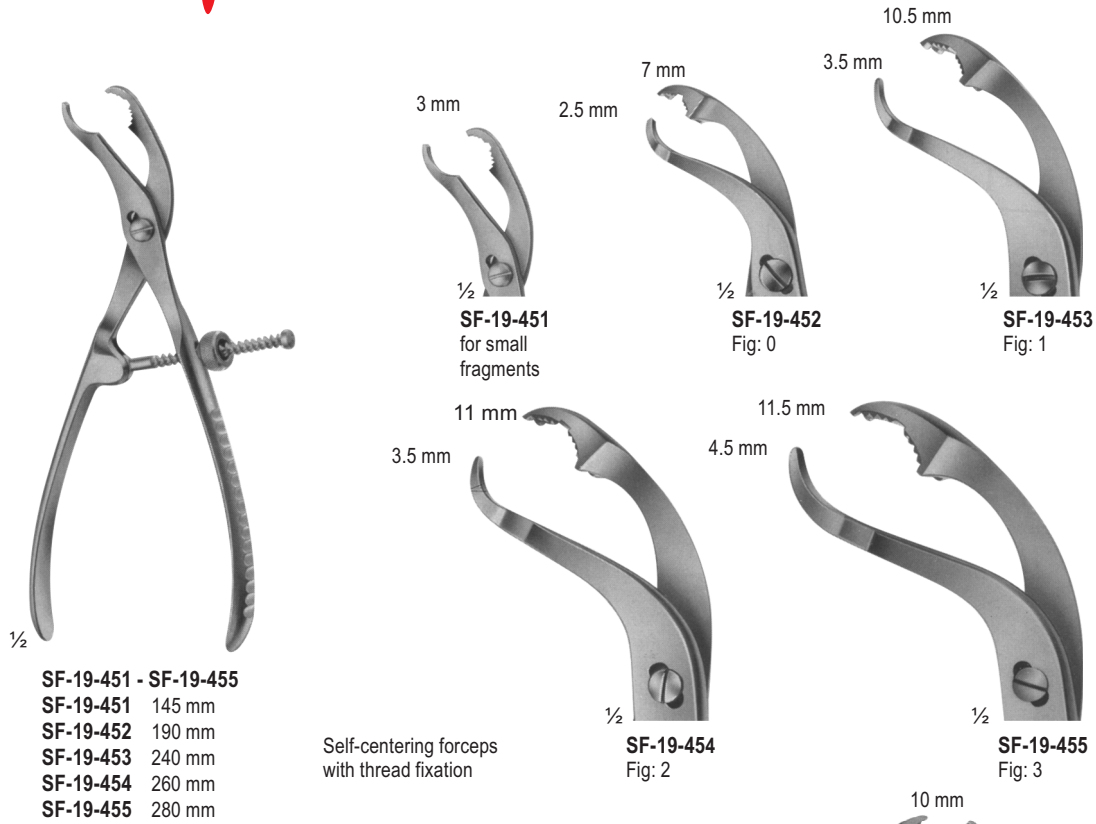



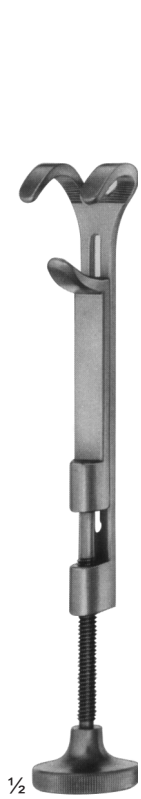

**SF-19-460 - SF-19-461**  
LOWMAN  
**SF-19-460** 170 mm  
**SF-19-461** 205 mm



**SF-19-462**  
LOWMAN-GERSTER  
210 mm



**SF-19-463**  
LOWMAN-HOGLUND  
175 mm

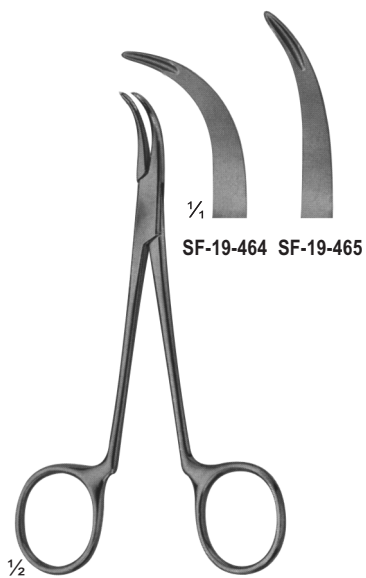

**SF-19-464 - SF-19-465**  
Synovectomy rongeur  
width of jaws 1.2 mm  
130 mm

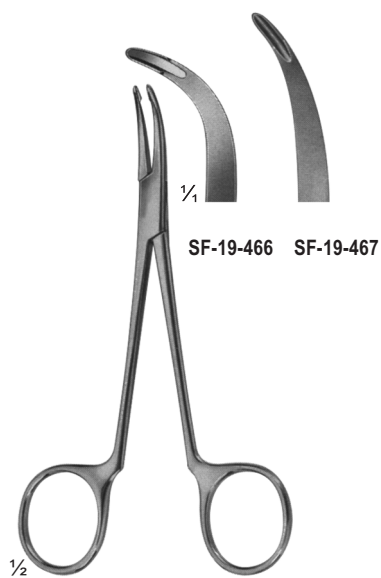

**SF-19-466 - SF-19-467**  
Synovectomy rongeur  
width of jaws 2.0 mm  
130 mm

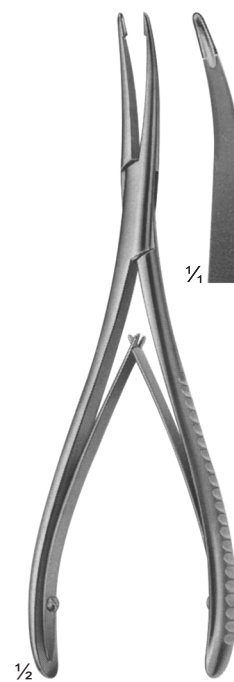

**SF-19-468**  
STELLBRINK  
Synovectomy rongeur  
175 mm

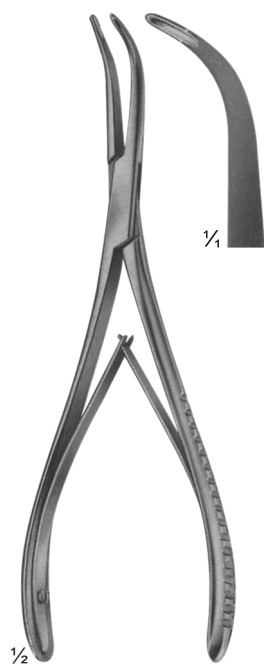

**SF-19-469**  
STELLBRINK  
Synovectomy rongeur  
170 mm

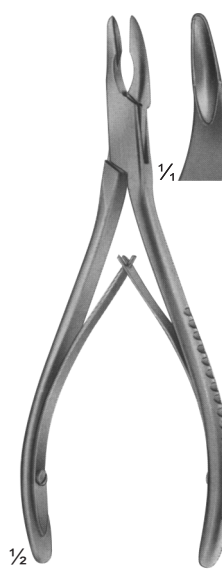

**SF-19-470**  
LURE-FRIEDMANN  
145 mm

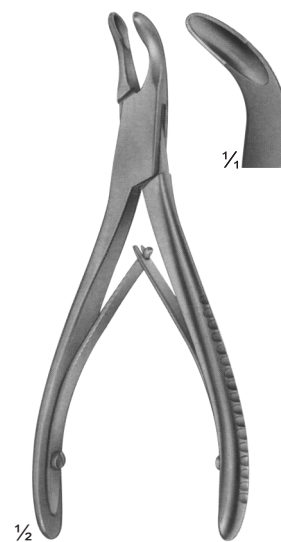

**SF-19-471**  
140 mm



**SF-19-472**  
LURE  
150 mm

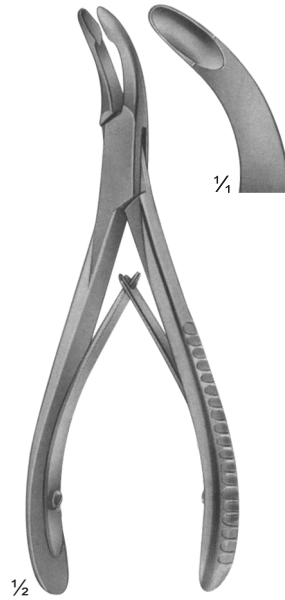

**SF-19-473**  
LURE  
155 mm

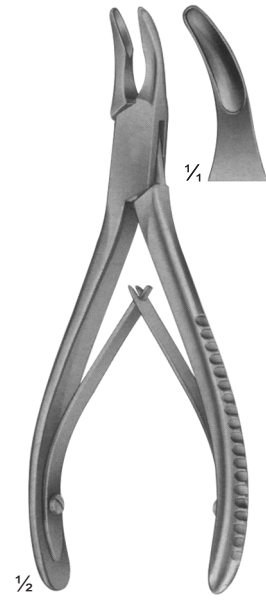

**SF-19-474**  
BLUMENTHAL  
155 mm

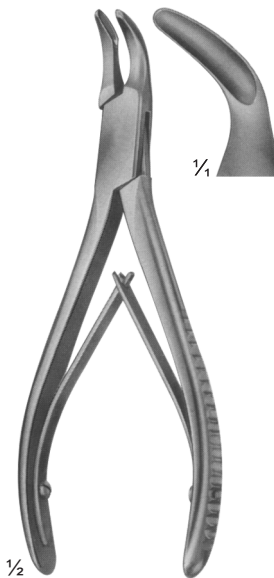

**SF-19-475**  
BLUMENTHAL  
150 mm

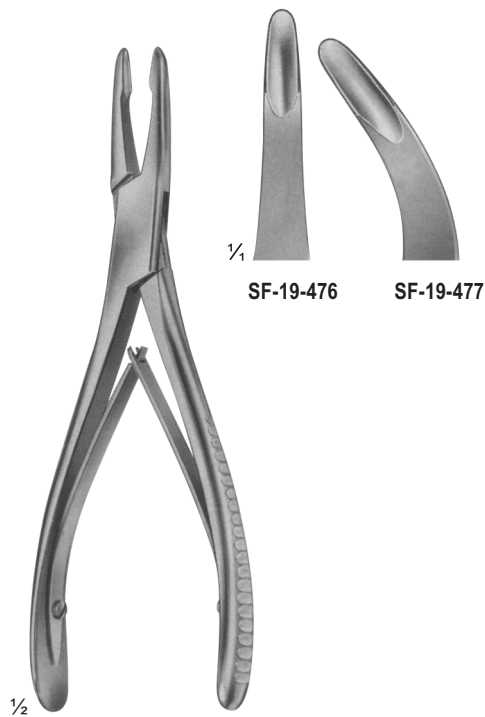

**SF-19-476 - SF-19-477**  
JANSEN  
175 mm

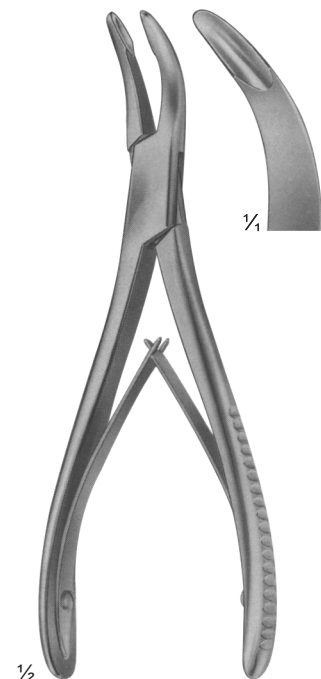

**SF-19-478**  
BANE-HARTMANN  
175 mm

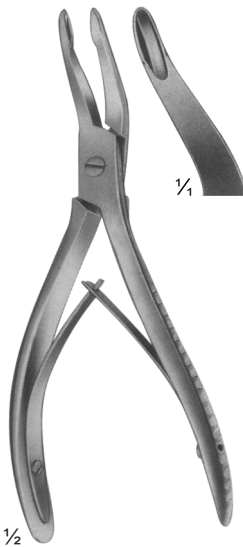

**SF-19-479**  
ALEXANDER  
140 mm

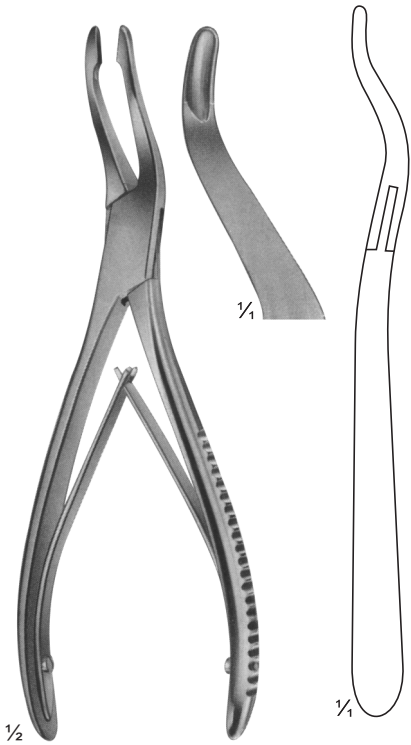

**SF-19-480**  
JANSEN  
190 mm

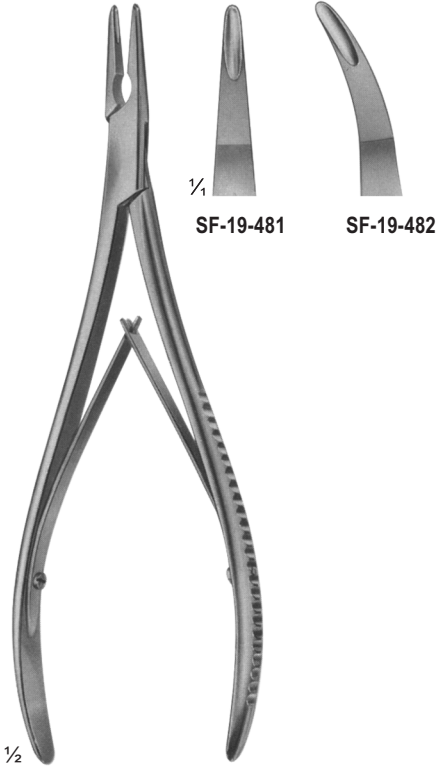

**SF-19-481 - SF-19-482**  
LEMPERT  
200 mm

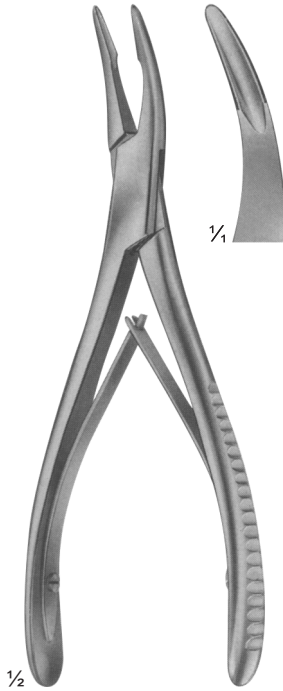

**SF-19-483**  
BEYER  
180 mm

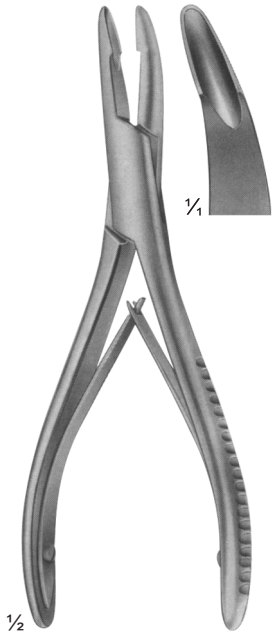

**SF-19-484**  
MEAD  
165 mm

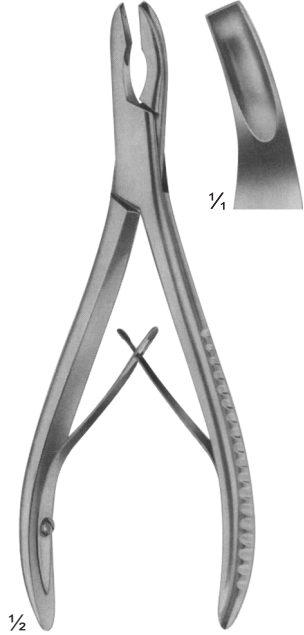

**SF-19-485**  
MEAD  
165 mm

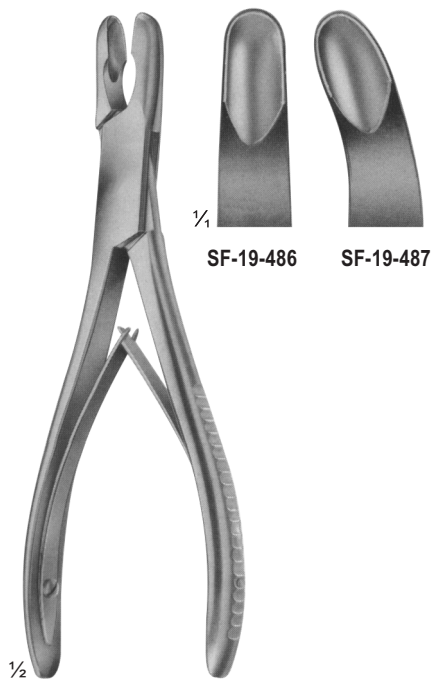

SF-19-486 SF-19-487

SF-19-486 - SF-19-487  
LURE  
175 mm

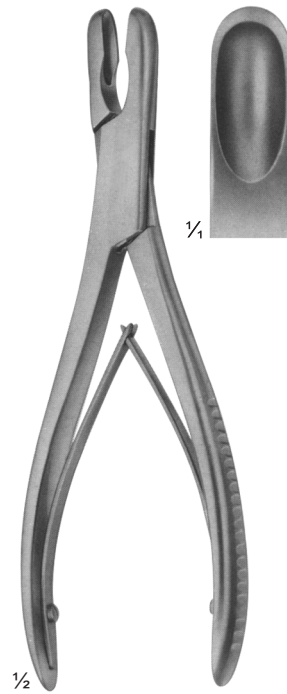

SF-19-488  
LURE  
180 mm

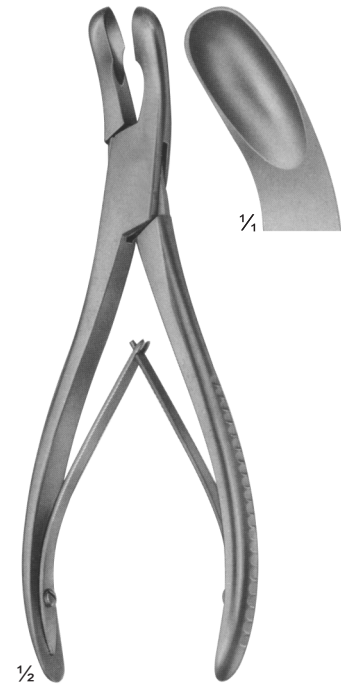

SF-19-499  
LURE  
180 mm

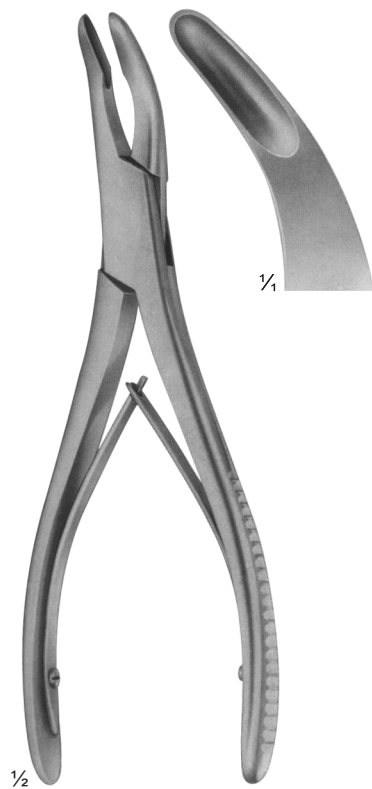

SF-19-490  
OLIVECRONA  
205 mm



SF-19-491 - SF-19-492  
BOHLER  
155 mm

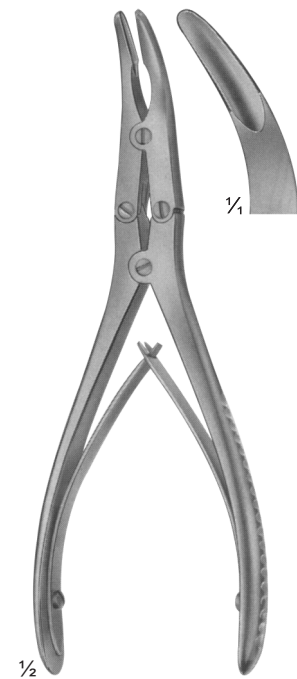

SF-19-493  
MARQUARTD  
200 mm

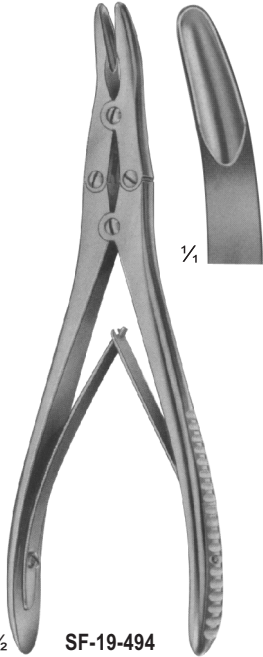

1/2 **SF-19-494**  
RUSKIN  
190 mm

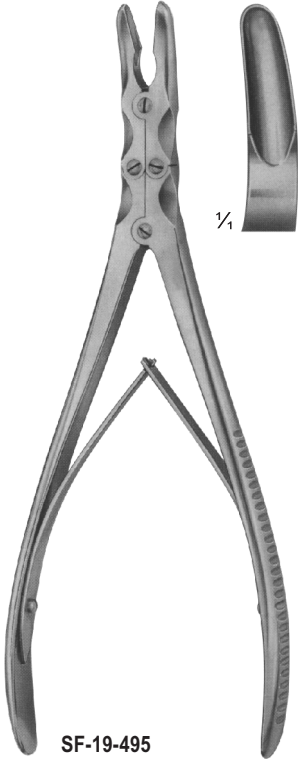

1/2 **SF-19-495**  
ROTTGEN-RUSKIN  
240 mm

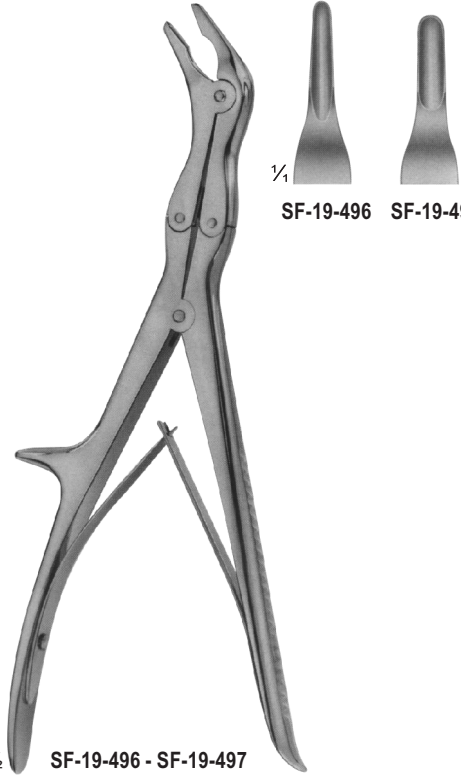

1/2 **SF-19-496 - SF-19-497**  
ECHLIN  
230 mm



1/2 **SF-19-498**  
STILLE  
235 mm



1/2 **SF-19-499**  
LEKSELL-STILLE  
240mm

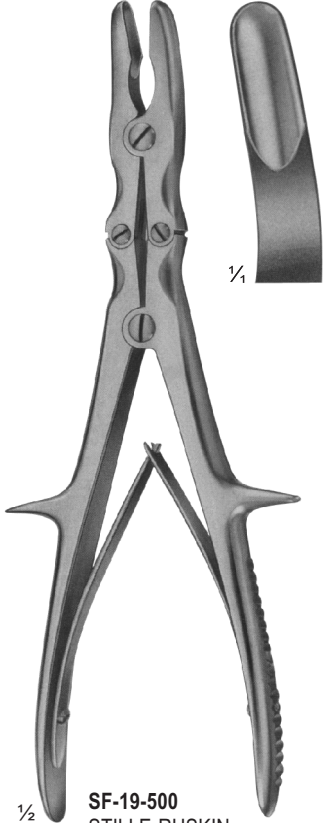

1/2 **SF-19-500**  
STILLE-RUSKIN  
240mm

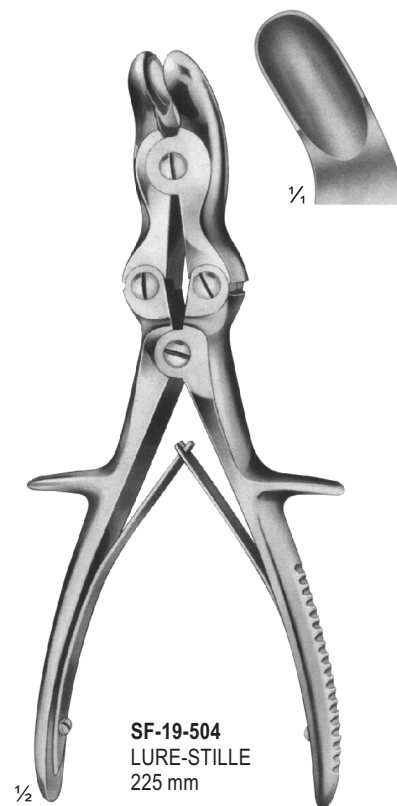
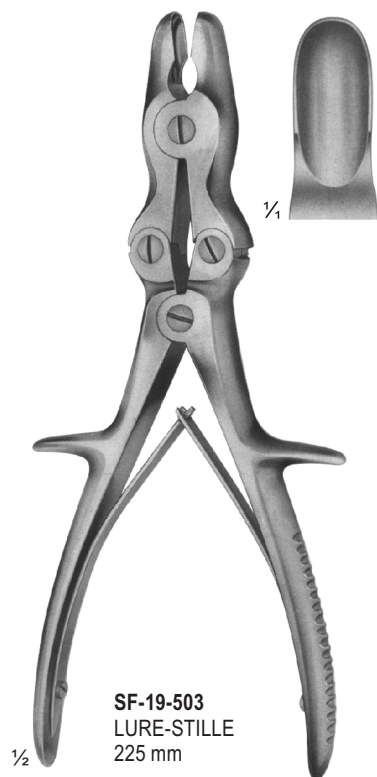
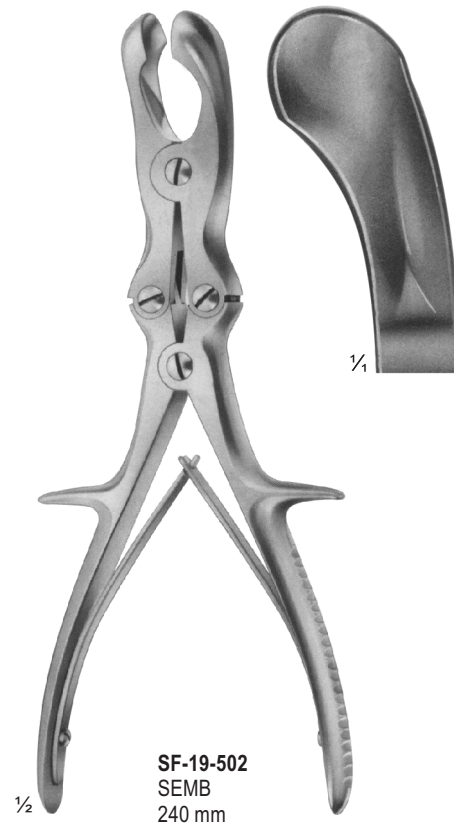
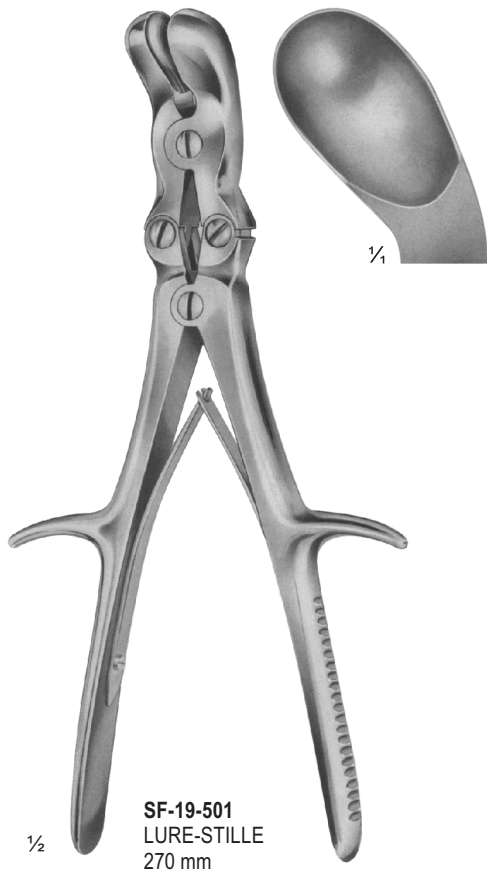

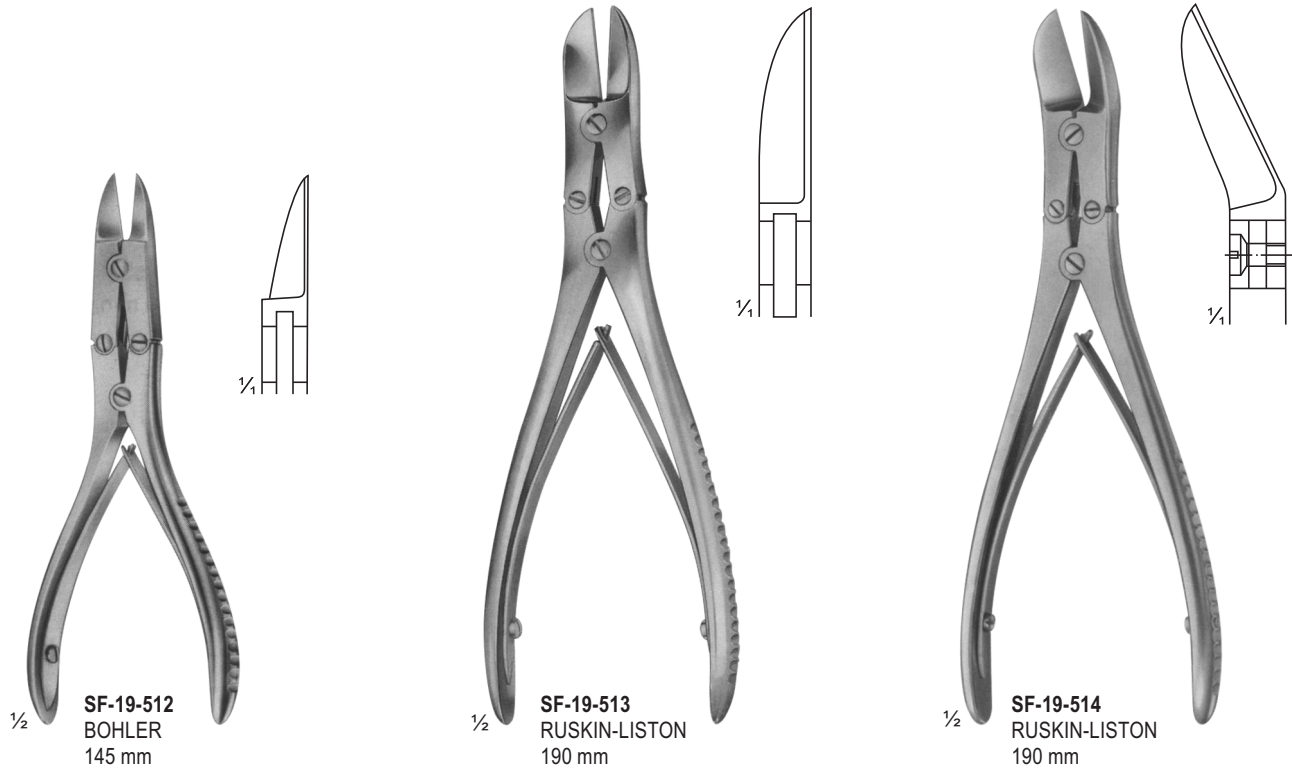
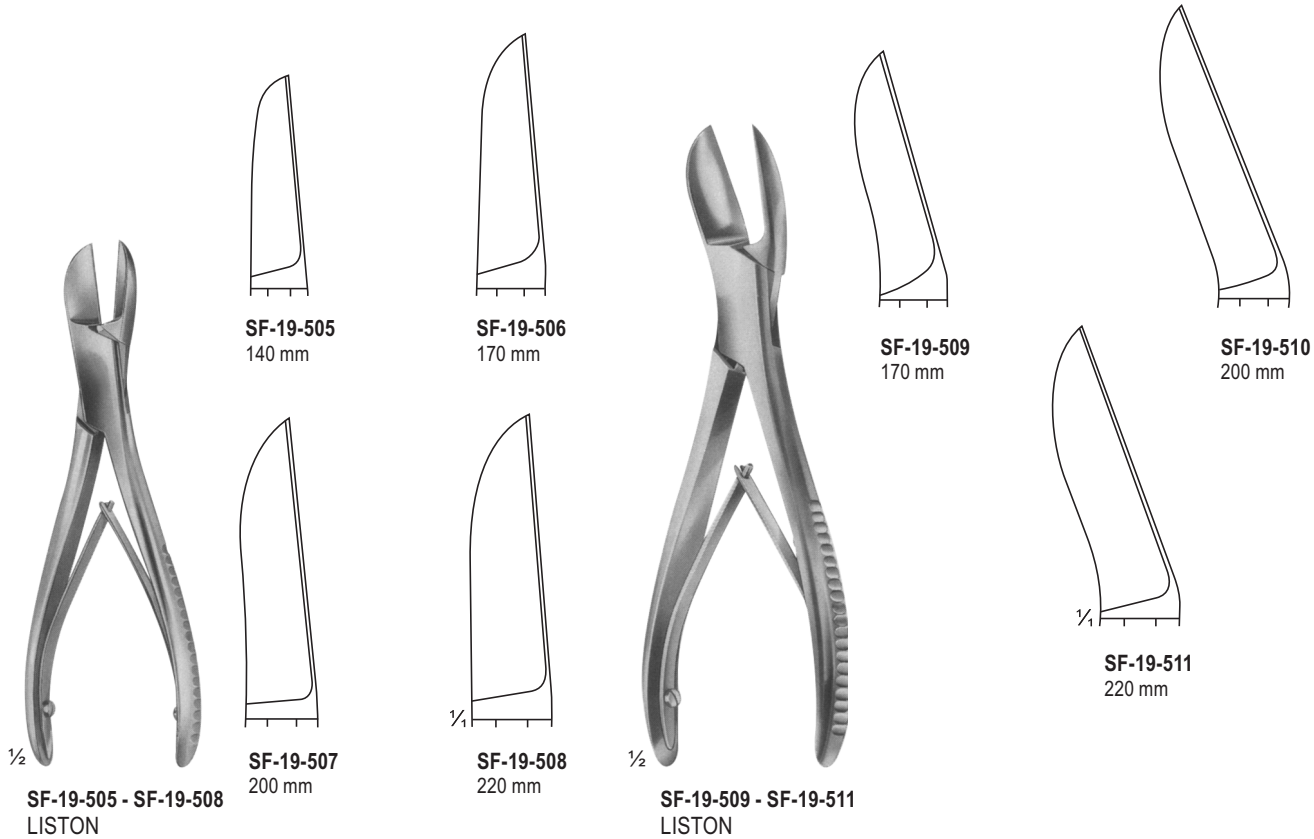



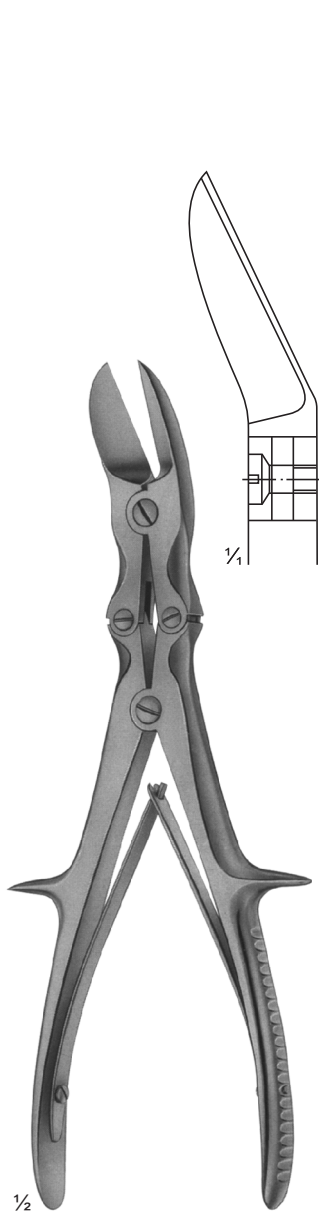

**SF-19-515**  
LISTON  
curved on flat  
240 mm

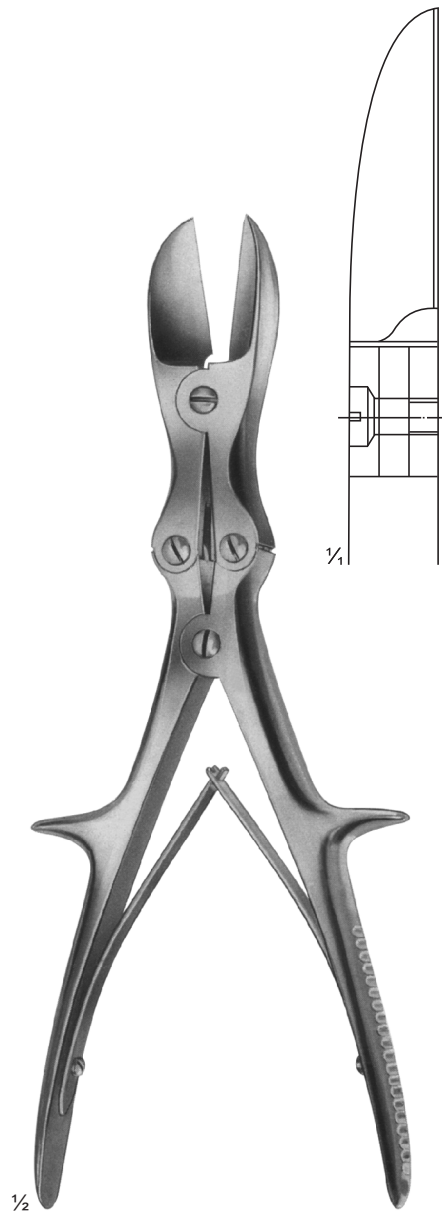

**SF-19-516**  
LISTON  
straight  
280 mm

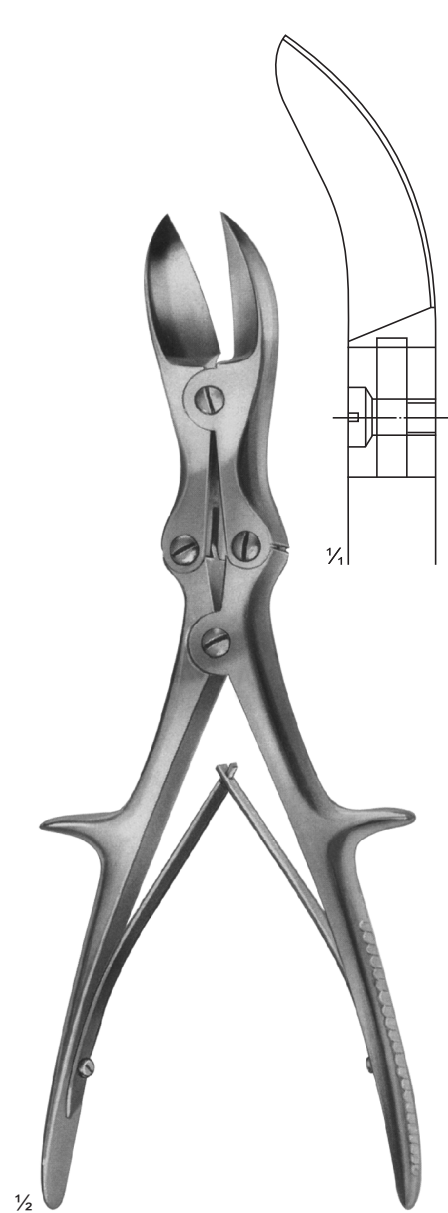

**SF-19-517**  
LISTON  
curved on flat  
280 mm

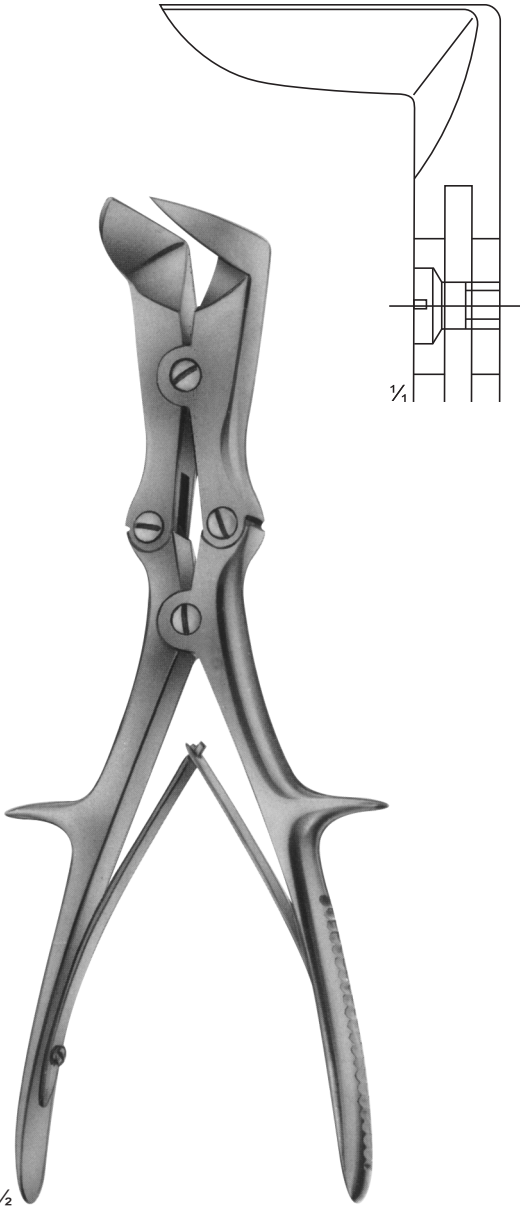

**SF-19-518**  
LISTON-STILLE  
265 mm

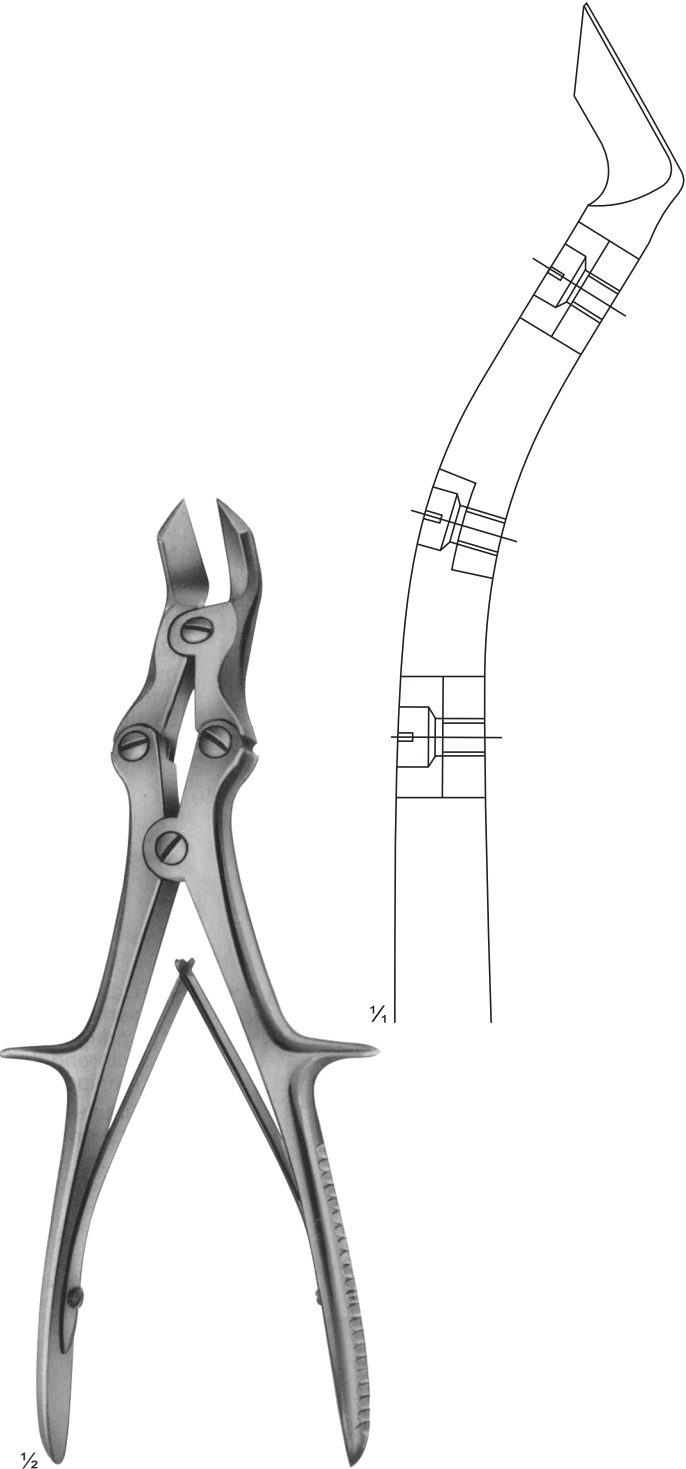

**SF-19-519**  
LISTON-KEY-HORSLEY  
(TUDOR EDWARDS)  
255 mm

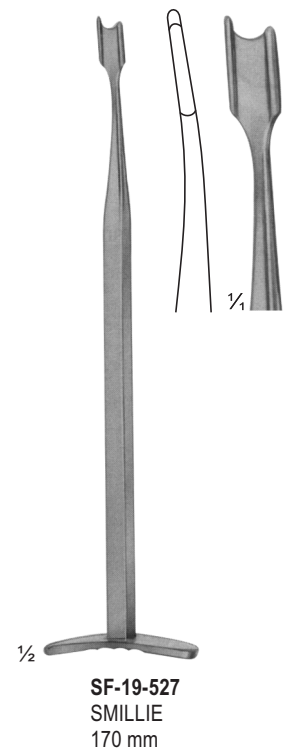
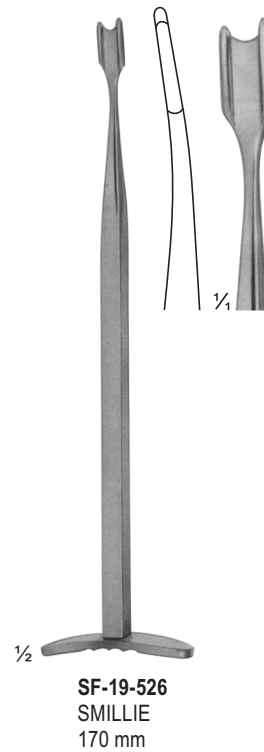
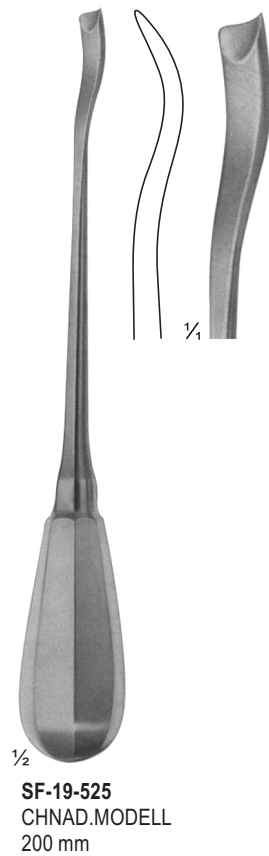
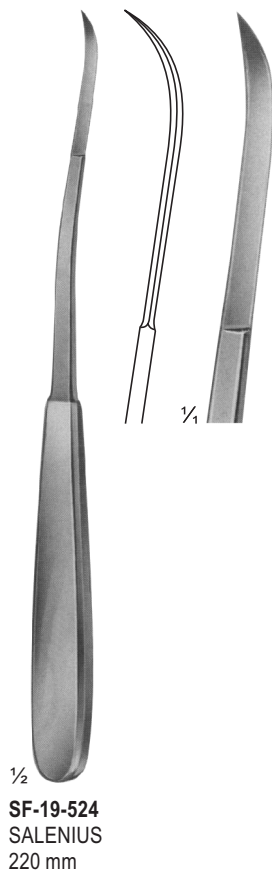
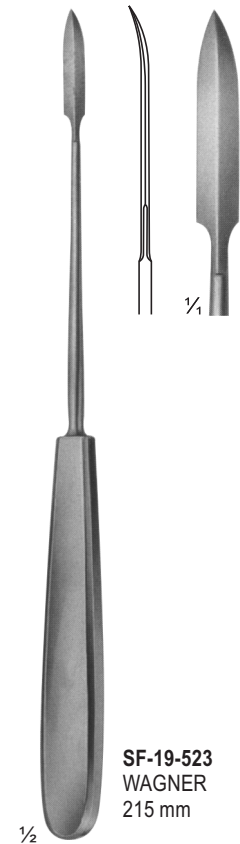
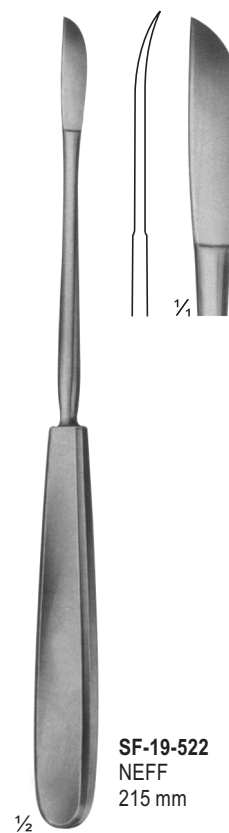
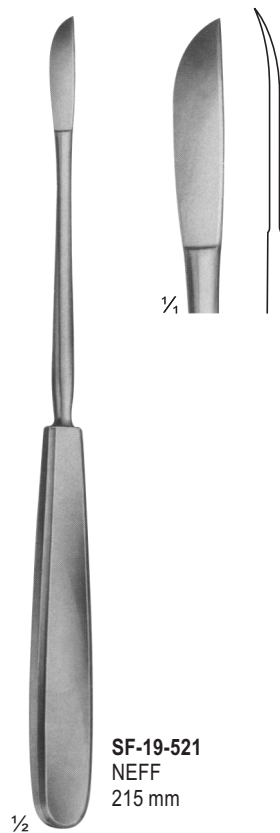
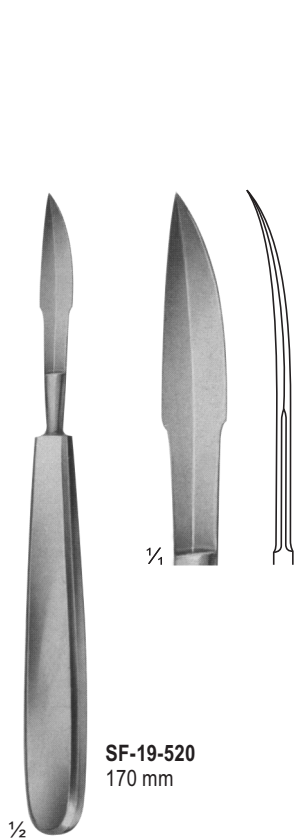

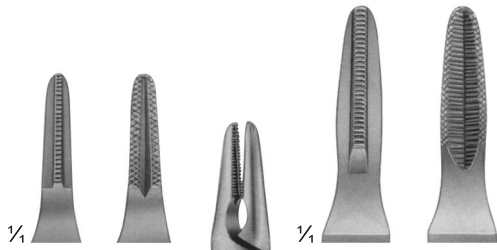

**SF-19-528**  
130 mm

**SF-19-529**  
180 mm



Extraction pliers  
for boring wires  
**SF-19-528 - SF-19-529**



Flat-nosed pliers,  
parallel  
**SF-19-530**  
185 mm

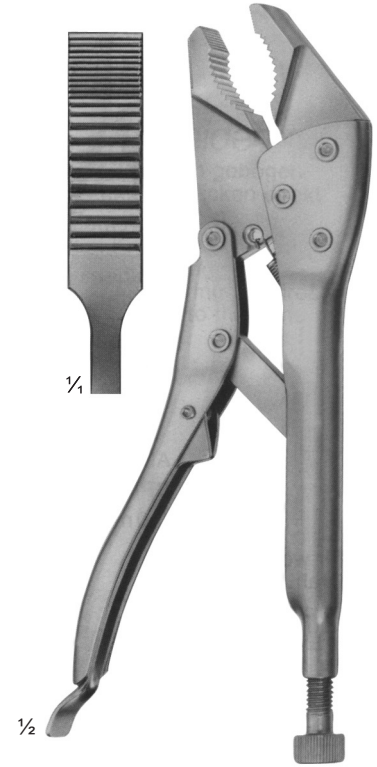
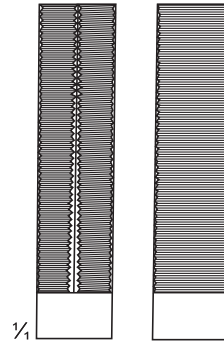

Vise grip  
**SF-19-531**  
200 mm

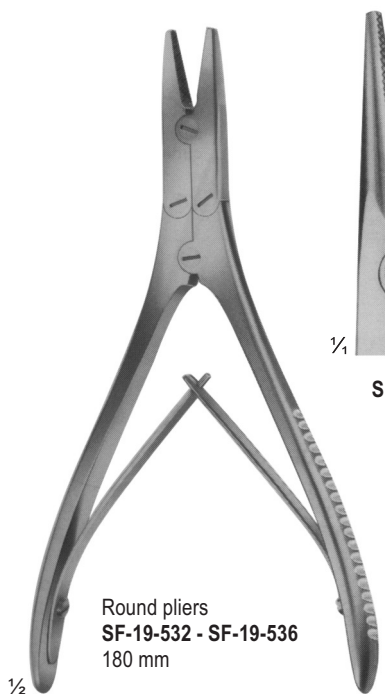

Round pliers  
**SF-19-532 - SF-19-536**  
180 mm

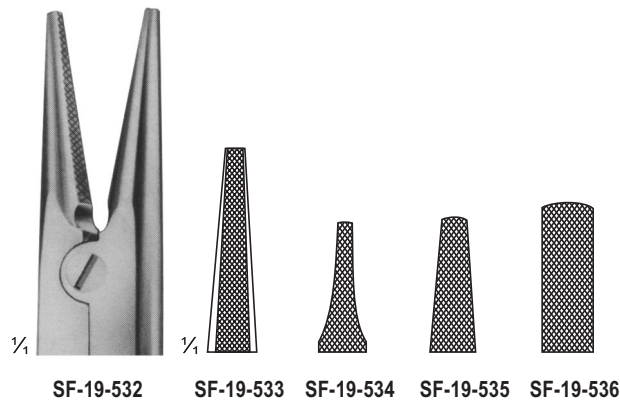

**SF-19-533**  
**SF-19-534** 14.5 cm  
**SF-19-535** 18 cm  
**SF-19-536** 18 cm  
Extraction pliers for wires

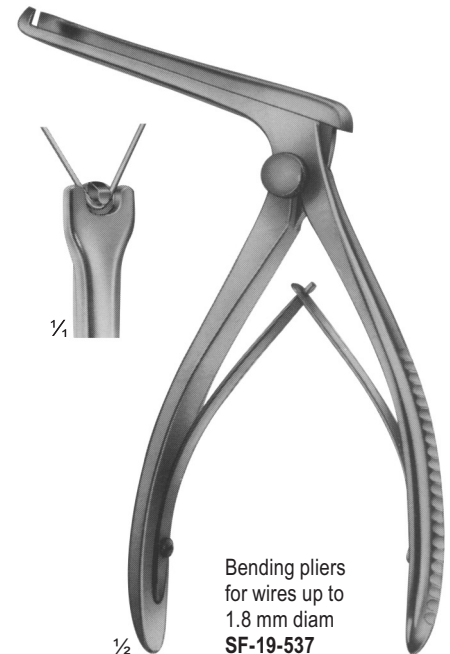

Bending pliers  
for wires up to  
1.8 mm diam  
**SF-19-537**



**BOHLER**  
**SF-19-538**  
145 mm

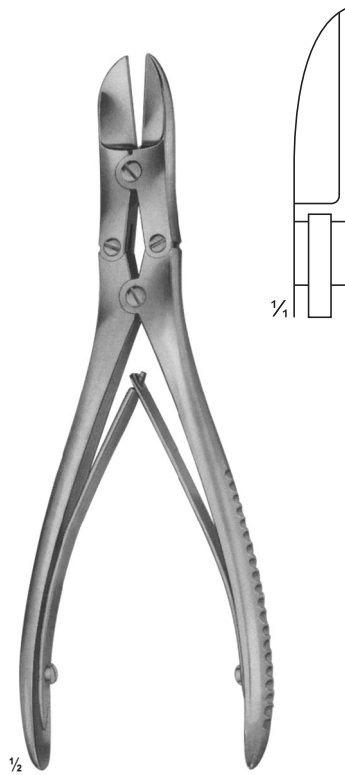

**RUSKIN-LISTON**  
**SF-19-539**  
190 mm

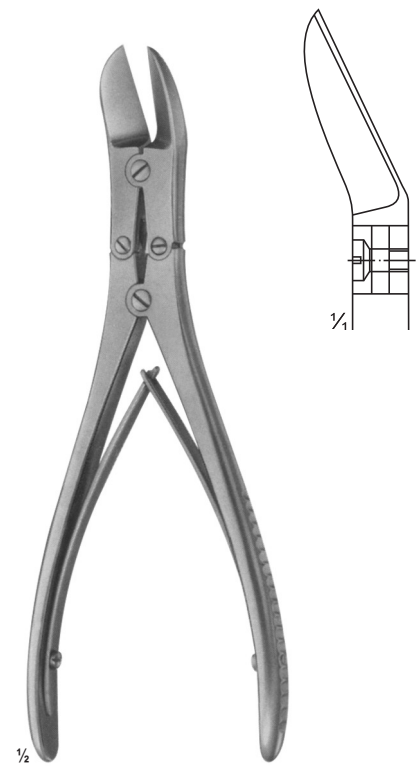

**RUSKIN-LISTON**  
**SF-19-540**  
190 mm

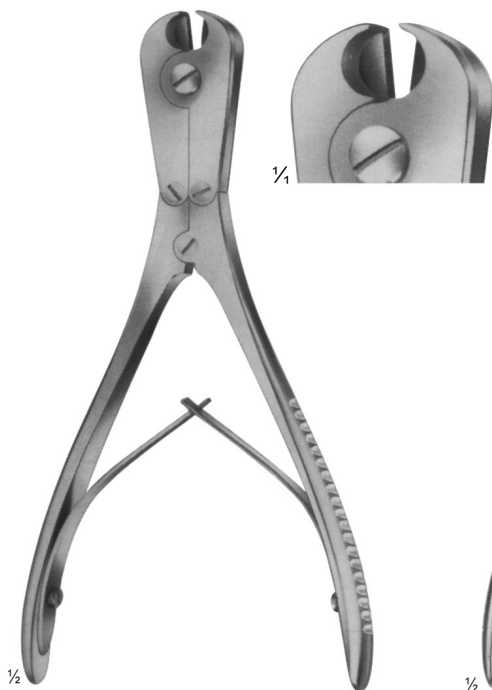

**SF-19-541**  
180 mm

for soft wire  
up to diam. 2,0 mm  
For hard wire 1,5 mm  
up to diam  
specially hardened  
cutting edges, front  
and lateral cutting  
action



**REILL**  
**SF-19-542**  
175 mm

for soft wire  
up to diam. 2,0 mm  
For hard wire 1,6 mm  
up to diam  
specially hardened  
cutting edges, for  
cutting off wires close  
to the bone



**SF-19-543**  
235 mm

for soft wire  
up to diam. 3,0 mm  
For hard wire 2,2 mm  
up to diam



**SF-19-544**  
240 mm

for soft wire up to diam. 2 mm  
For hard wire up to diam. 1.6 mm

**SF-19-545**  
140 mm

for soft wire up to diam. 1.5 mm  
For hard wire up to diam. 1 mm

**SF-19-546**  
145 mm

for soft wire up to diam. 2 mm  
For hard wire up to diam. 1.5 mm

**SF-19-547**  
220 mm

for soft wire up to diam. 3.5 mm  
For hard wire up to diam. 2.5 mm



**SF-19-548**  
320 mm

for soft wire up to diam. 3 mm  
For hard wire up to diam 3 mm

Cutter for cutting off KIRSCHNER wires, Tibia head screws, bolts, pins, up to 3 mm diam.



Durotip

**SF-19-549**  
Cutter for cutting off KIRSCHNER wires, Tibia head screws, bolts, pins, up to 6 mm diam.  
470 mm



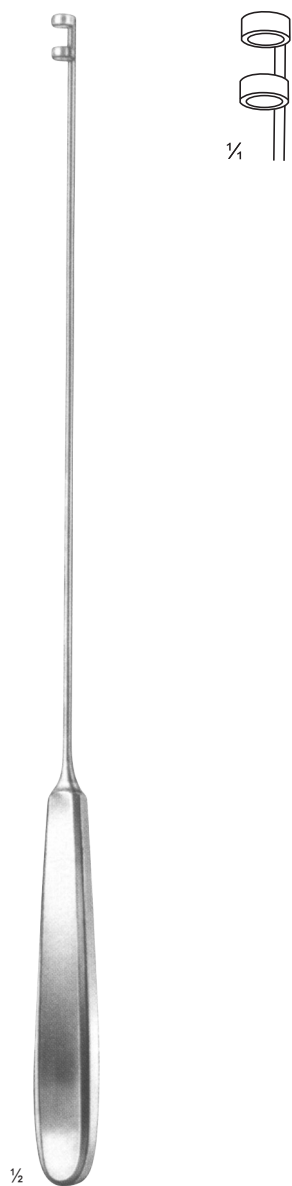

FISCHER  
SF-19-550  
310 mm  
Blunt

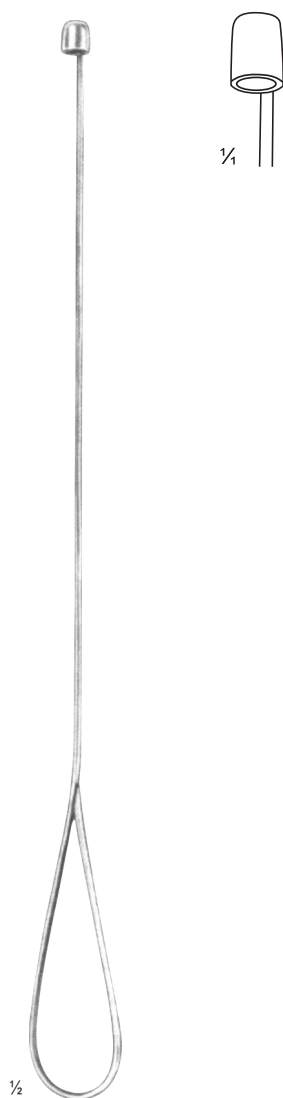

SF-19-551  
285 mm

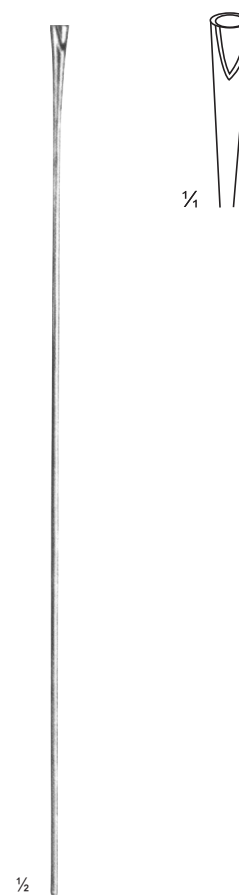

BUNNELL  
SF-19-552  
230 mm  
Tendon Passer

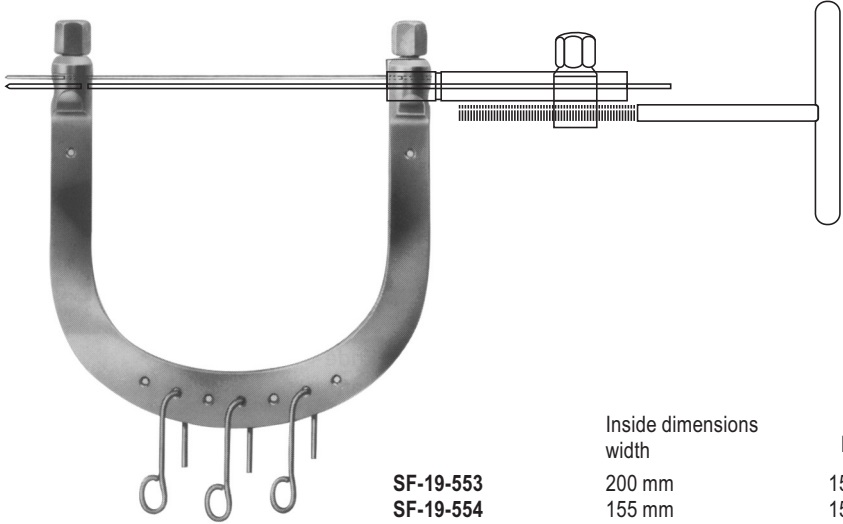

**KIRSCHNER  
SF-19-553 - SF-19-559**  
Wire traction bows,  
to be used with  
KIRSCHNER-wires  
up to 2.5 mm diam.,  
With 3 hooks,  
stainless steel

	Inside dimensions width	Depth
<b>SF-19-553</b>	200 mm	155 mm
<b>SF-19-554</b>	155 mm	155 mm
<b>SF-19-555</b>	135 mm	130 mm
<b>SF-19-556</b>	120 mm	120 mm
<b>SF-19-557</b>	105 mm	100 mm
<b>SF-19-558</b>	95 mm	110 mm
<b>SF-19-559</b>	95 mm	70 mm



**SF-19-560**  
Wrench, double - ended,  
for wire traction bows

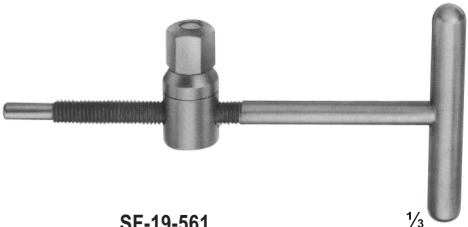

**SF-19-561**  
Wire tightener, with  
clamping jaws



**SF-19-562**  
Traction hook only,  
large size



**SF-19-563**  
Traction hook only,  
small size

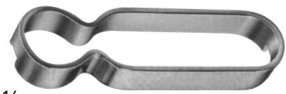

**SF-19-564**  
Fixation clamp, to secure clamping  
jaws of stainless steel

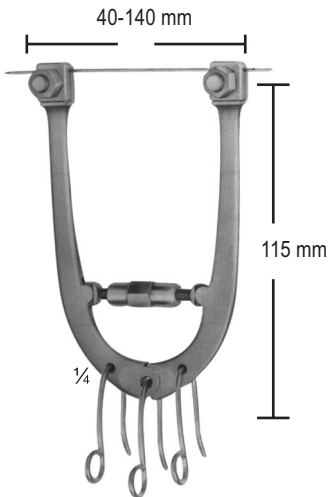

**SF-19-565**  
Wire traction bow, adjustable,  
with 3 hooks, small size

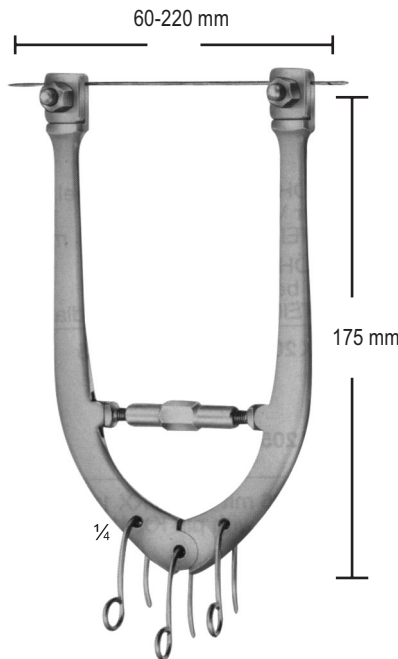

**SF-19-566**  
Wire traction bow, adjustable,  
with 3 hooks, large size

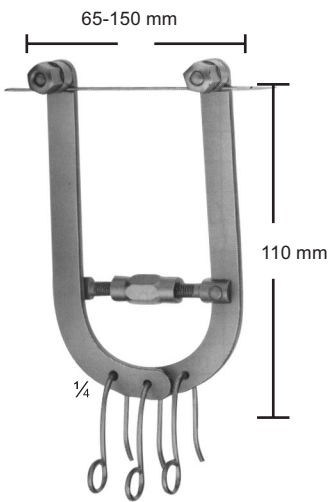

**SF-19-567**  
Wire traction bow, adjustable,  
with 3 hooks, large size for  
elbow and calcaneus, for  
adolescents

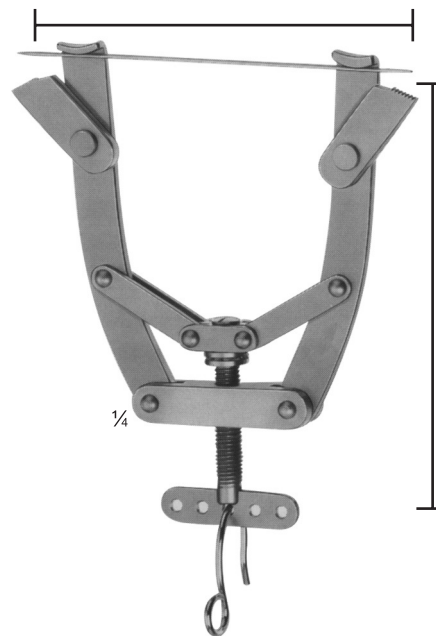

**KIRSCHNER**  
**SF-19-570 - SF-19-575**  
Wire traction bow, modified  
adjustable in with width, holds wire  
securely, with 1 hook

- SF-19-570 10 cm
- SF-19-571 16 cm
- SF-19-572 20 cm

- SF-19-573 1.6 mm
- SF-19-574 2 mm
- SF-19-575 2.5 mm



**SF-19-568**  
Fixation disc, slotted



**SF-19-569**  
idem, aluminum, transparent  
to X-rays

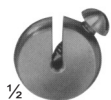

**SF-19-576** 1/2  
Fixation disc, slotted



**SF-19-577**  
Screw driver, for above  
fixations discs

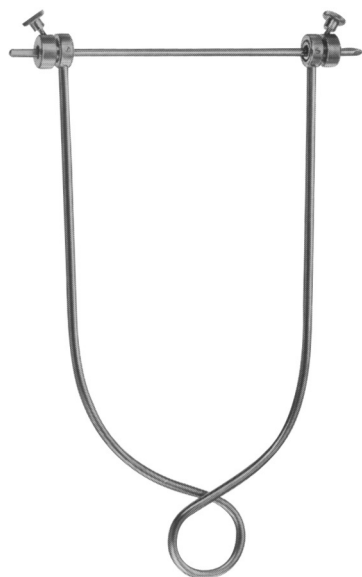

**SF-19-578 - SF-19-585**  
Screw driver, for above  
fixations discs

Steinmann pins, 4 mm daim.	Steinmann pins, 5 mm daim.
<b>SF-19-578</b> with pin	16x9cm Arm
<b>SF-19-579</b> without pin	<b>SF-19-580-00</b> without
<b>SF-19-581</b> with pin	21x11cm Arm
<b>SF-19-582</b> without pin	<b>SF-19-583</b> without
<b>SF-19-584</b> with pin	21x15cm Arm
<b>SF-19-585</b> without pin	



**SF-19-586**  
**SCHWARZ**  
Traction bow for fingers,  
to be used with KIRSCHNER-  
wire up to 1.6 mm diam.

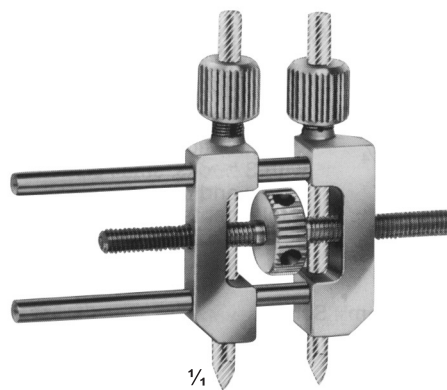

**SF-19-587**  
Small distractor  
as a repositioning device for  
distraction and compression of small bones,  
for wires with 3 mm diam.

10-40 mm



STEINMANN  
**SF-19-588 - SF-500**  
 triangular shaft ended  
 and trocar point

Length	4 mm	5 mm
80 mm	<b>SF-19-588</b>	
100 mm	<b>SF-19-589</b>	
120 mm	<b>SF-19-590</b>	
140 mm	<b>SF-19-591</b>	
150 mm	<b>SF-19-592</b>	<b>SF-19-593</b>
160 mm	<b>SF-19-594</b>	
180 mm	<b>SF-19-595</b>	<b>SF-19-596</b>
200 mm	<b>SF-19-597</b>	<b>SF-19-598</b>
210 mm	<b>SF-19-599</b>	
250 mm	<b>SF-19-600</b>	<b>SF-19-601</b>
300 mm		<b>SF-19-602</b>



**SF-19-603**  
 Protection cap  
 for 4 mm STEINMANN Pins

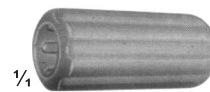

**SF-19-604**  
 Protection cap  
 for 5 mm STEINMANN Pins



**REILL**  
**SF-19-605**  
Drilling chuck,  
cannulated,  
for shanks from  
2.0 - 2.5 mm diam  
115 mm

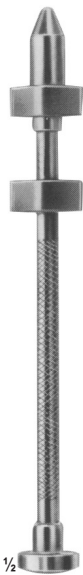

**SF-19-606**  
Drilling chuck,  
cannulated,  
for shanks from  
0.8 - 2.0 mm diam  
150 mm



**SF-19-607**  
Drilling chuck,  
cannulated,  
for shanks up to  
4.5 mm diam  
with key  
140 mm



**LOUTE**  
**SF-19-608**  
Wire tightener, improved pattern,  
with movable tip,  
for wires up to 1.0 mm diam.  
220 mm



**SF-19-609**  
Drilling chuck, cannulated,  
for shanks up to 6.35 mm diam.,  
To be tightened by hand  
100 mm



**SF-19-610**  
Drilling chuck, cannulated,  
for shanks up to 4.5 mm diam.,  
And for triangular shaft width  
across flats 4.7 mm



**SF-19-611**  
Drilling chuck, cannulated,  
for shanks up to 6.35 mm diam.,  
With key  
160 mm

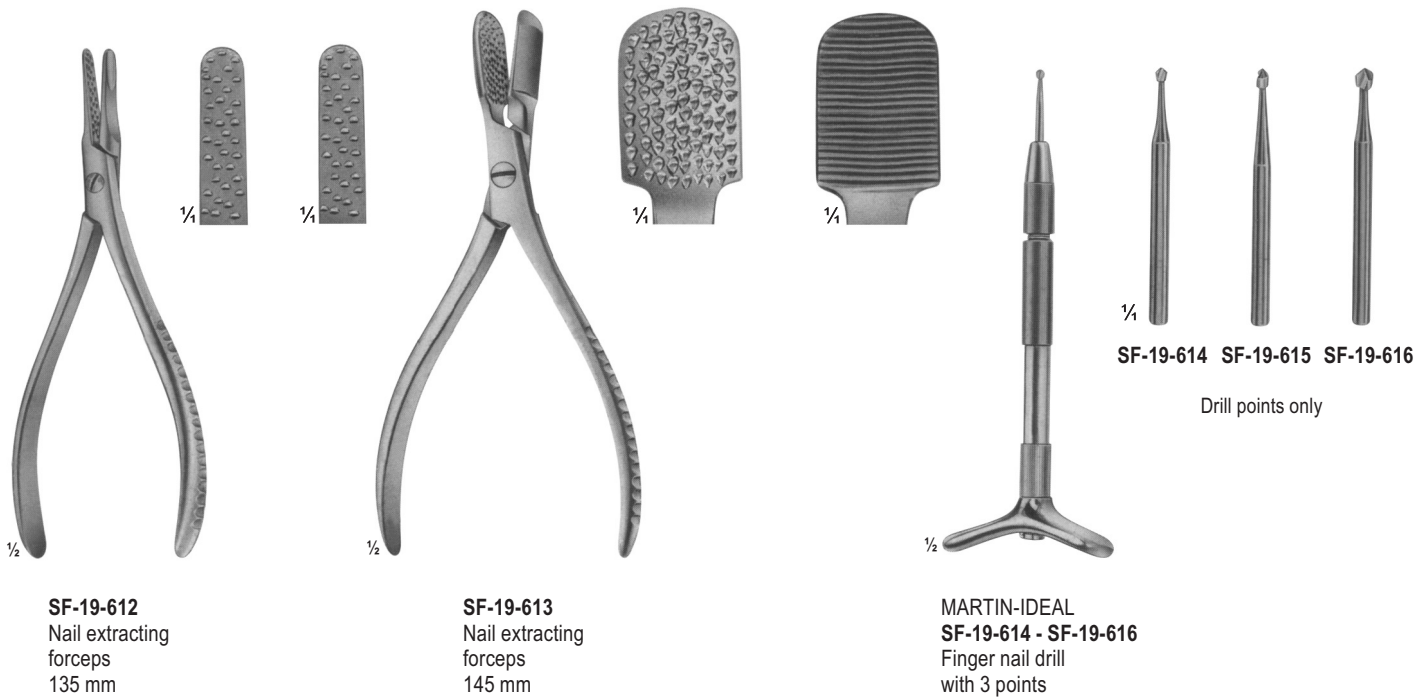

**SF-19-612**  
Nail extracting  
forceps  
135 mm

**SF-19-613**  
Nail extracting  
forceps  
145 mm

**MARTIN-IDEAL**  
**SF-19-614 - SF-19-616**  
Finger nail drill  
with 3 points

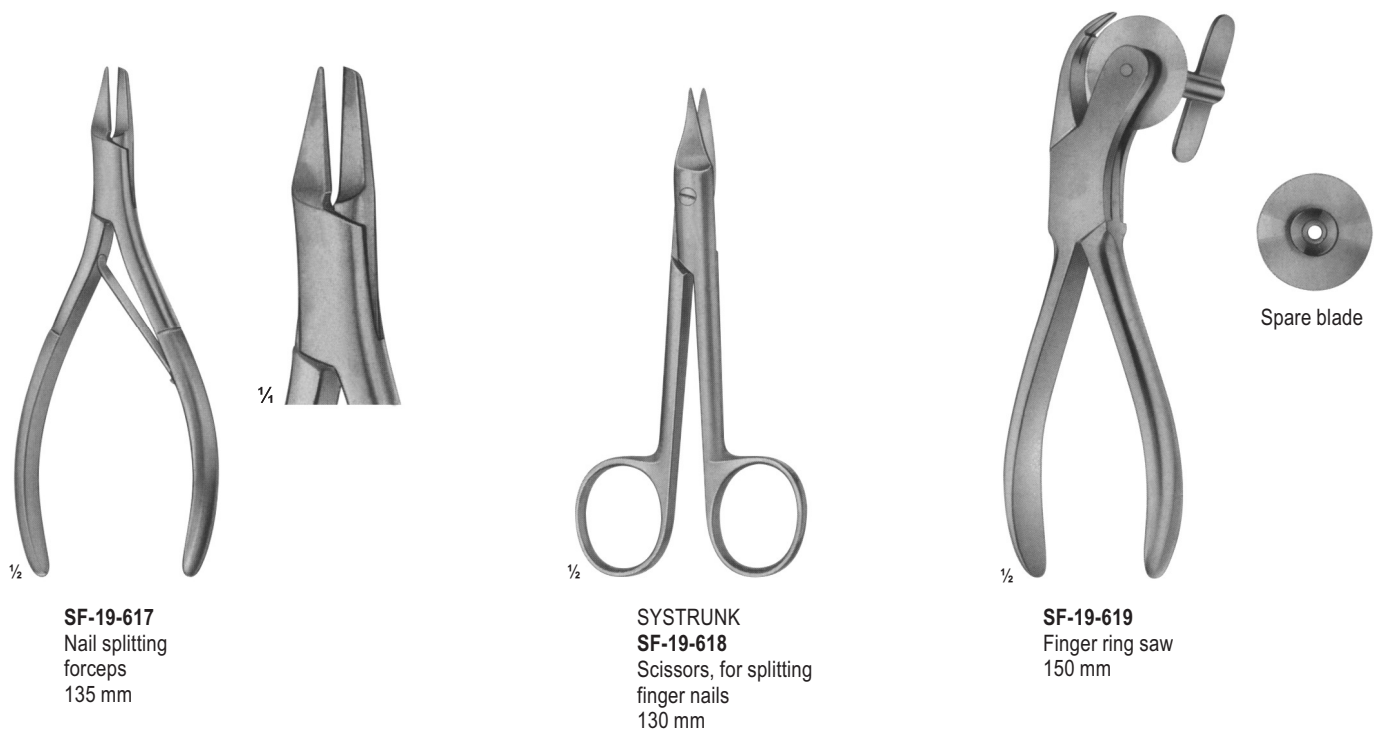

**SF-19-617**  
Nail splitting  
forceps  
135 mm

**SYSTRUNK**  
**SF-19-618**  
Scissors, for splitting  
finger nails  
130 mm

**SF-19-619**  
Finger ring saw  
150 mm

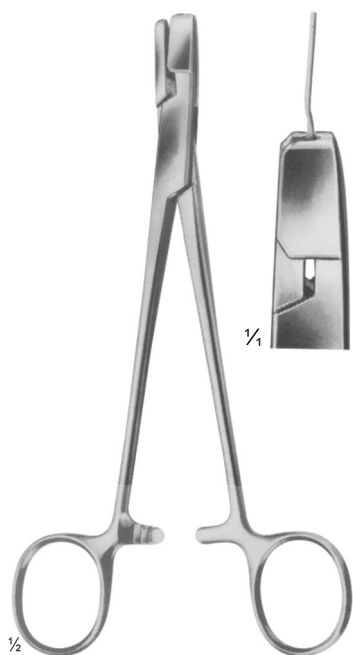

**DUROGRIP  
SF-19-620**  
Holding forceps for cerclage  
wire, with lateral jaws to avoid  
wire slipping off  
170 mm



**DUROGRIP  
SF-19-621**  
Wire, tightening pliers,  
Ligature pliers  
150 mm



**DUROGRIP  
SF-19-622**  
Wire, tightening pliers,  
Ligature pliers  
150 mm

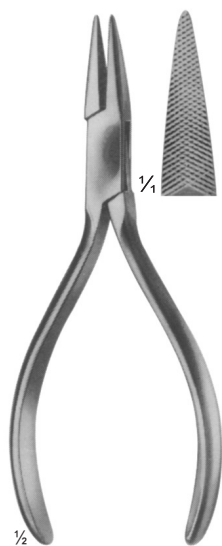

**SF-19-623**  
with serrated jaws  
140 mm

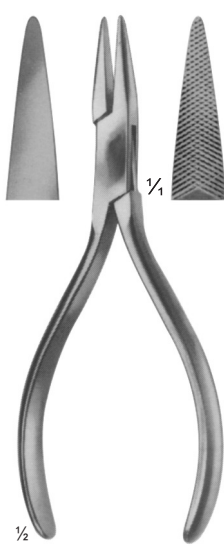

**SF-19-624**  
one jaws smooth,  
one jaws serrated  
140 mm



**SF-19-625**  
with serrated jaws  
**SF-19-626**  
with longitudinal and  
transversal grooves  
170 mm

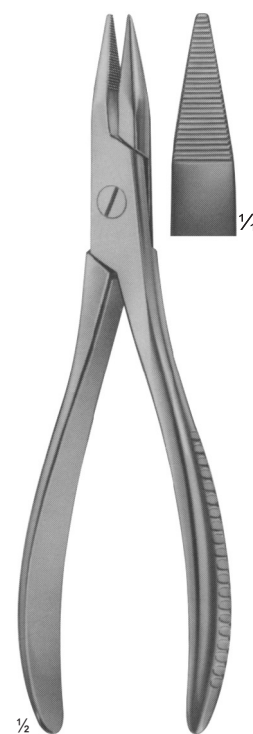

**SF-19-627**  
190 mm





Durotip

**SF-19-628**  
Cutter for cutting off  
KIRSCHNER wires,  
Tibia head screws,  
bolts, pins, up to 6 mm diam.  
47 cm



**SF-19-629**  
For Soft Wire  $\varnothing$ cm 3.5  
For Hars Wire  $\varnothing$ cm 2.5  
22 cm



**SF-19-630**  
For Soft Wire  $\varnothing$ cm 2.0  
For Hars Wire  $\varnothing$ cm 1.5  
22 cm

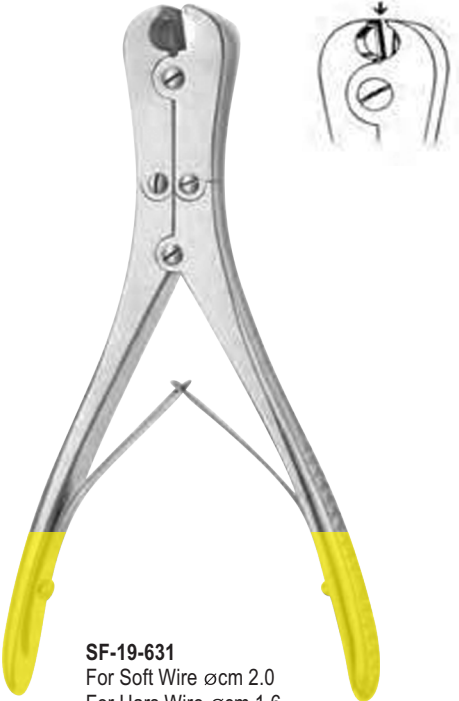

**SF-19-631**  
For Soft Wire  $\varnothing$ cm 2.0  
For Hars Wire  $\varnothing$ cm 1.6  
18 cm



**SF-19-632**  
17 cm



# Surgiforce Instruments



Opposite Surgical Association,  
Malkay Kalan, Marala Road,  
Sialkot-51050 Pakistan.



+92 523 559131



info@surgiforce.com  
sales@surgiforce.com



www.surgiforce.com



## Our Certifications:

ISO 9001	ISO 7151
CE Certified	ISO 17664:2004
EN 13485:2012	ISO 13402
ISO 7153-1	ISO 15223

