

Page  
396-406

- Gall Bladder, Liver and Spleen Instruments
- Genito Urinary Instruments

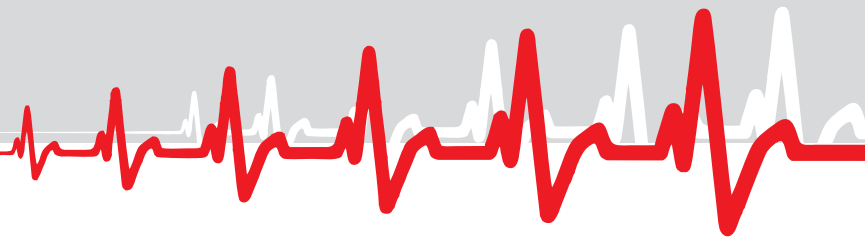

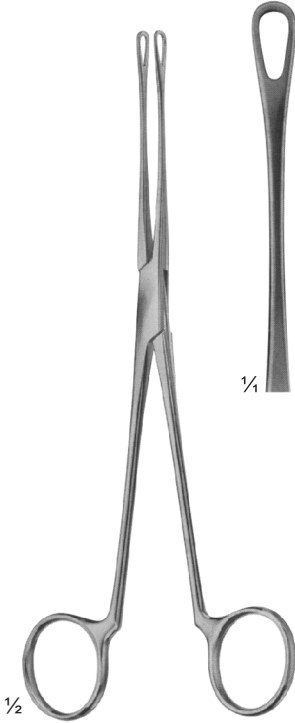

**SF-18-101**  
BLAKE  
205 mm

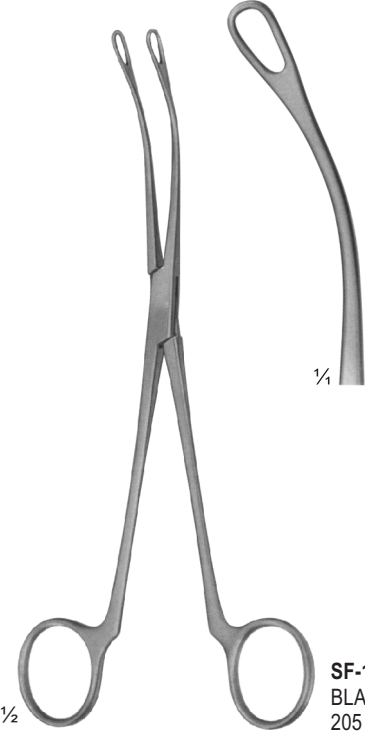

**SF-18-102**  
BLAKE  
205 mm

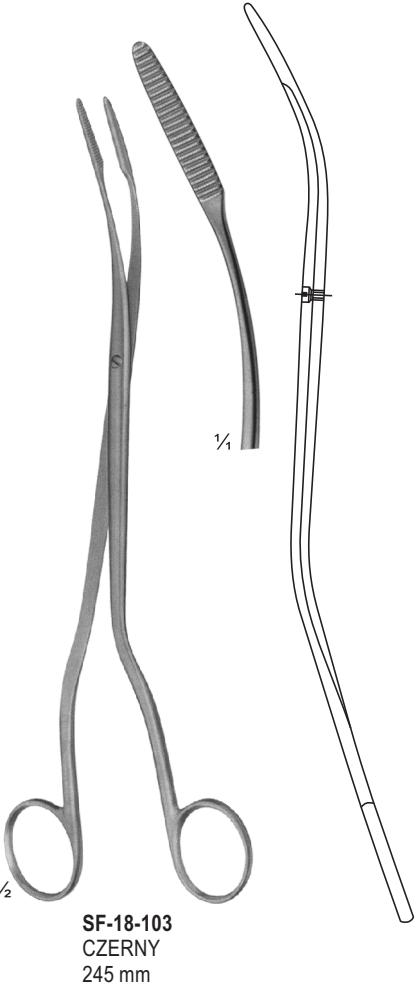

**SF-18-103**  
CZERNY  
245 mm

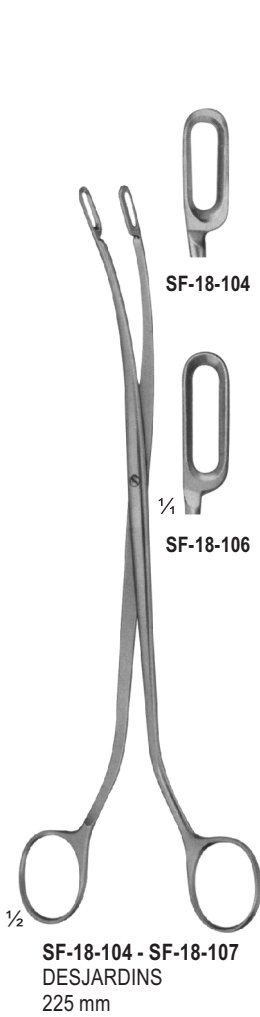

**SF-18-104 - SF-18-107**  
DESJARDINS  
225 mm

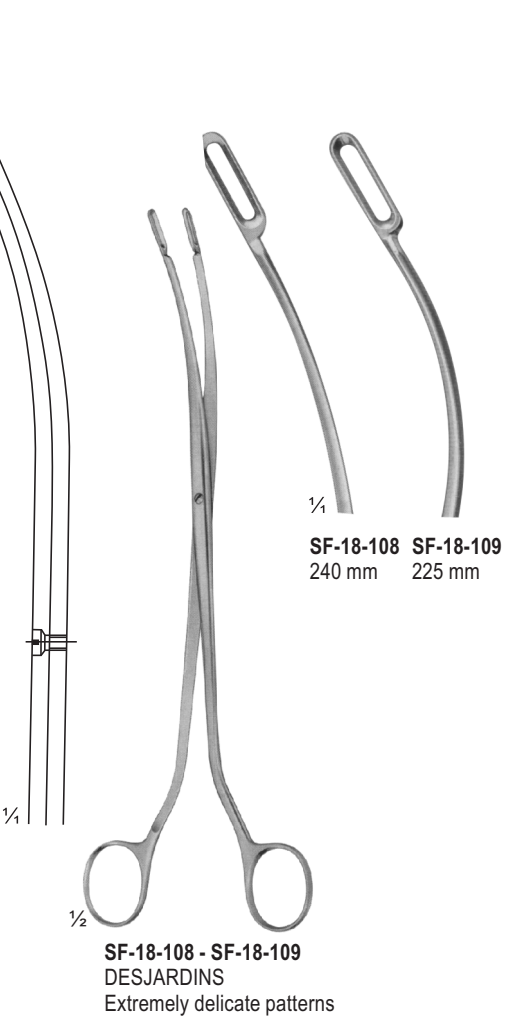

**SF-18-108 - SF-18-109**  
DESJARDINS  
Extremely delicate patterns  
240 mm 225 mm



SF-18-110



SF-18-114



SF-18-111



SF-18-115



1/2

SF-18-110 - SF-18-113  
RANDALL  
225 mm



SF-18-112



SF-18-113

1/4



1/2

SF-18-114 - SF-18-116  
RANDALL  
190 mm

1/4

SF-18-116

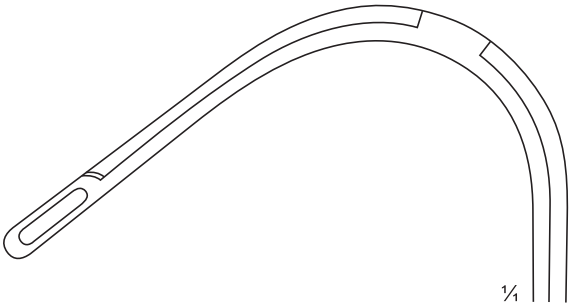

Fig. 1  
SF-18-117  
230 mm

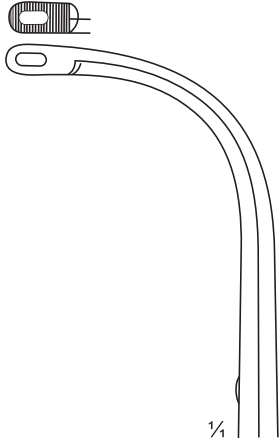

Fig. 1  
SF-18-119  
160 mm

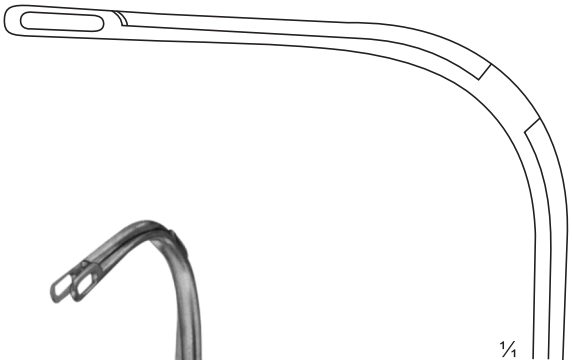
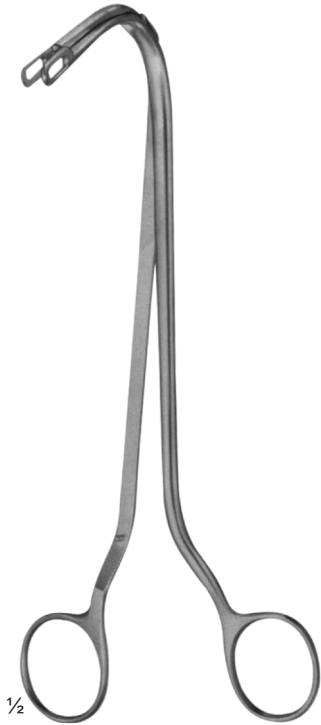

Fig. 2  
SF-18-118  
240 mm



RANDALL  
SF-18-117 - SF-18-118

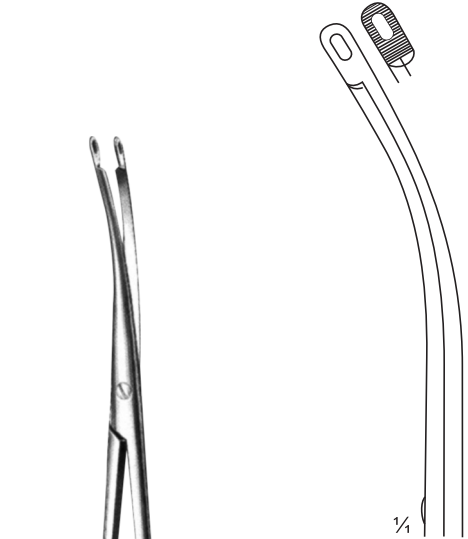
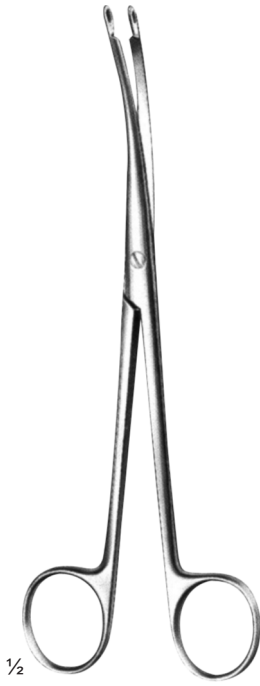

Fig. 1  
SF-18-120  
170 mm



HEIMING  
SF-18-119 - SF-18-120





ELSÄSSER  
SF-18-121 - SF-18-122  
210 mm

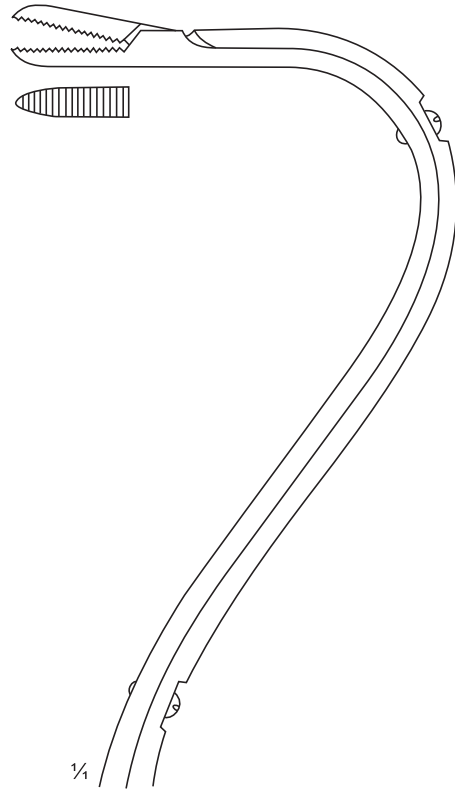

Fig. 1  
SF-18-121

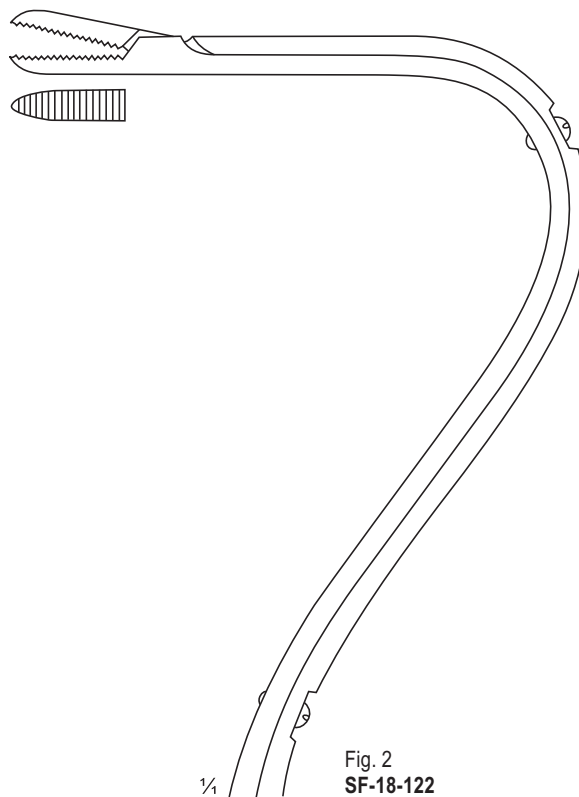
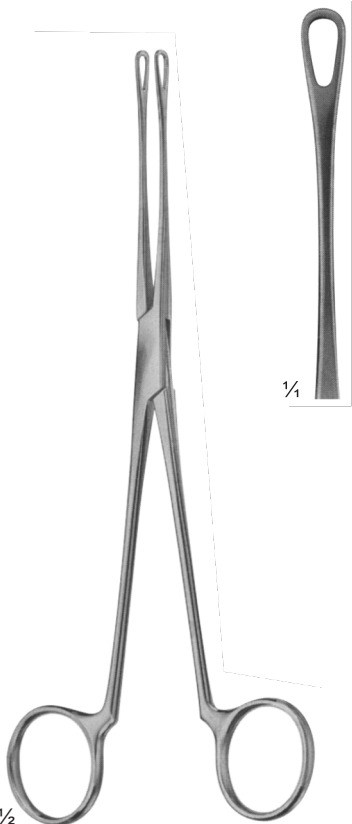
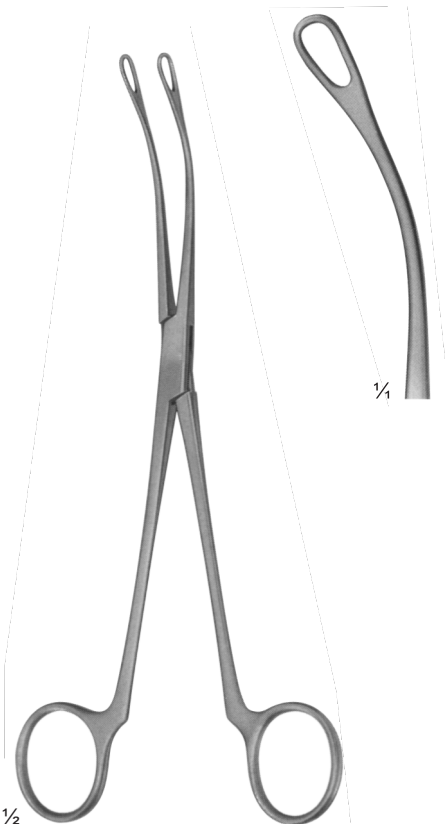

Fig. 2  
SF-18-122



BLAKE  
SF-18-123  
205 mm



BLAKE  
SF-18-124  
205 mm



MAYO-BLAKE  
SF-18-125  
210 mm



MAYO-BLAKE  
SF-18-126  
210 mm

ATRAUMA

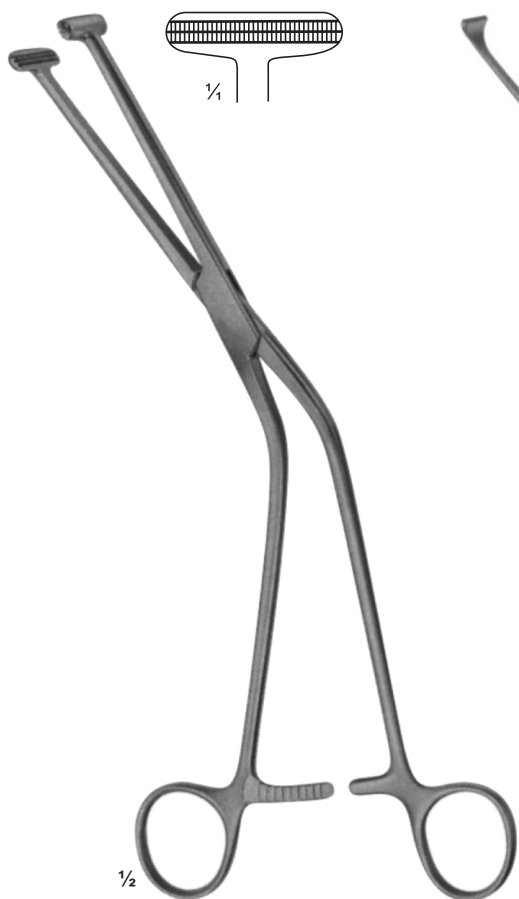

MILLIN  
Lobe grasping forceps  
**SF-18-127**  
235 mm

ATRAUMA

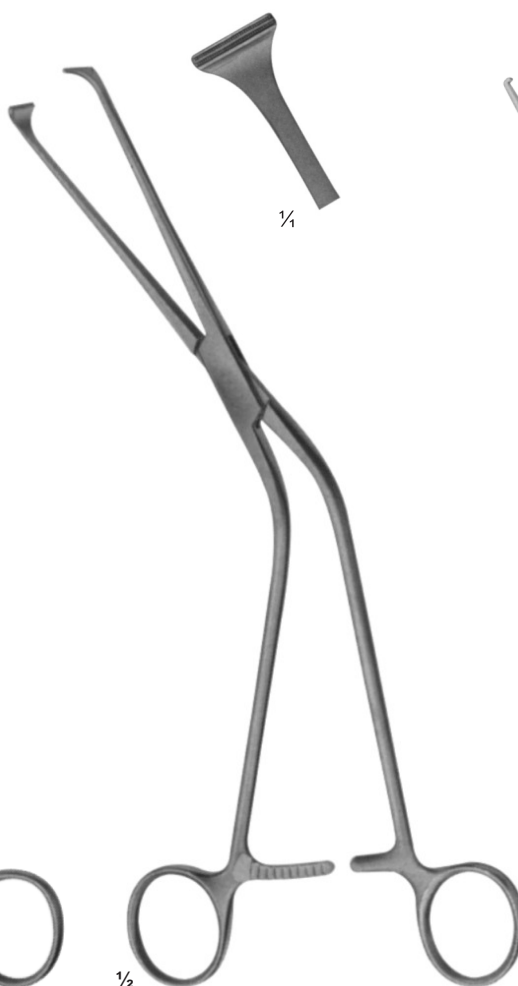

MILLIN  
Lobe grasping forceps  
**SF-18-128**  
245 mm



MILLIN  
Ligature holding forceps  
**SF-18-129**  
245 mm



LEGUEU  
SF-18-130  
270 mm



KOCHER  
SF-18-131  
260 mm



KOCHER  
SF-18-132  
260 mm

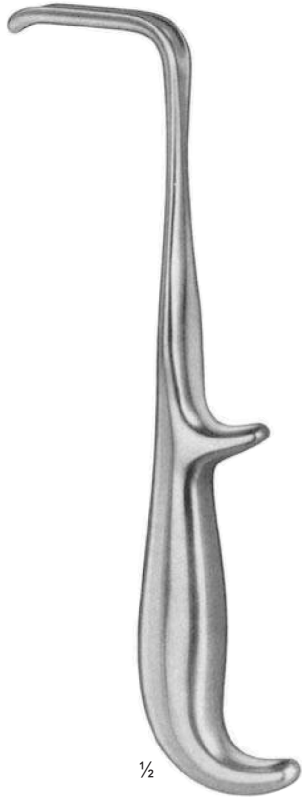

1/2

YOUNG  
SF-18-133  
210 mm



1/2

YOUNG  
SF-18-134  
220 mm



1/2

YOUNG  
SF-18-135  
210 mm



1/2

YOUNG  
SF-18-136  
220 mm

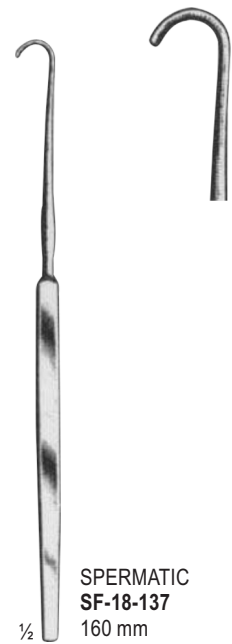

1/2

SPERMATIC  
SF-18-137  
160 mm

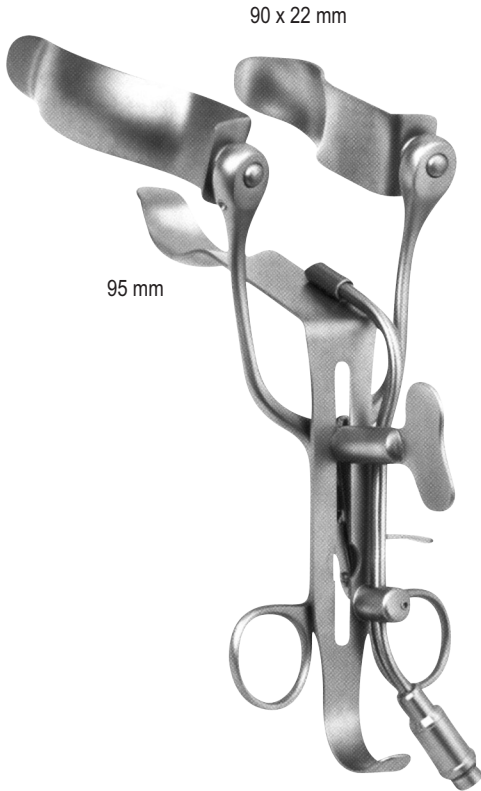

90 x 22 mm

95 mm

ALAN-PARKS  
SF-18-138  
150 mm

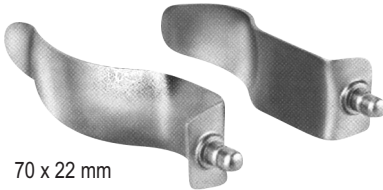

70 x 22 mm

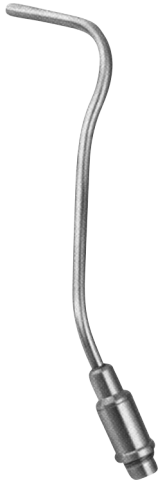

FIBER OPTIC  
SF-18-139

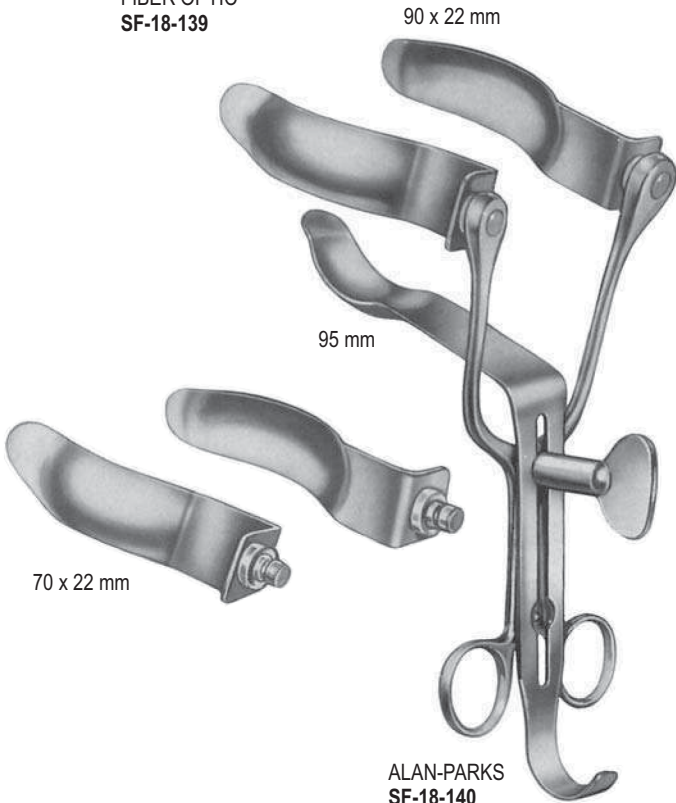

90 x 22 mm

95 mm

70 x 22 mm

ALAN-PARKS  
SF-18-140  
150 mm

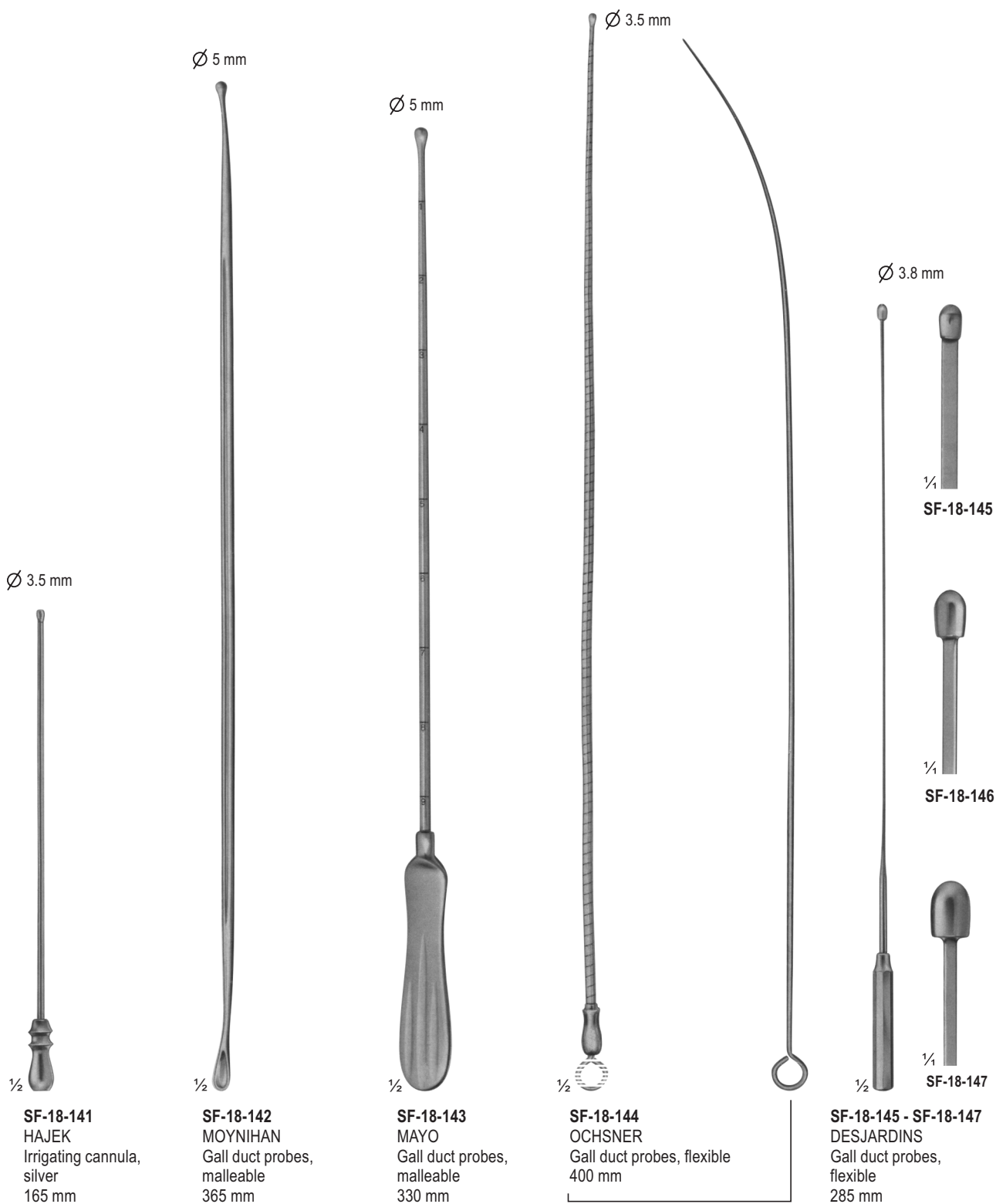

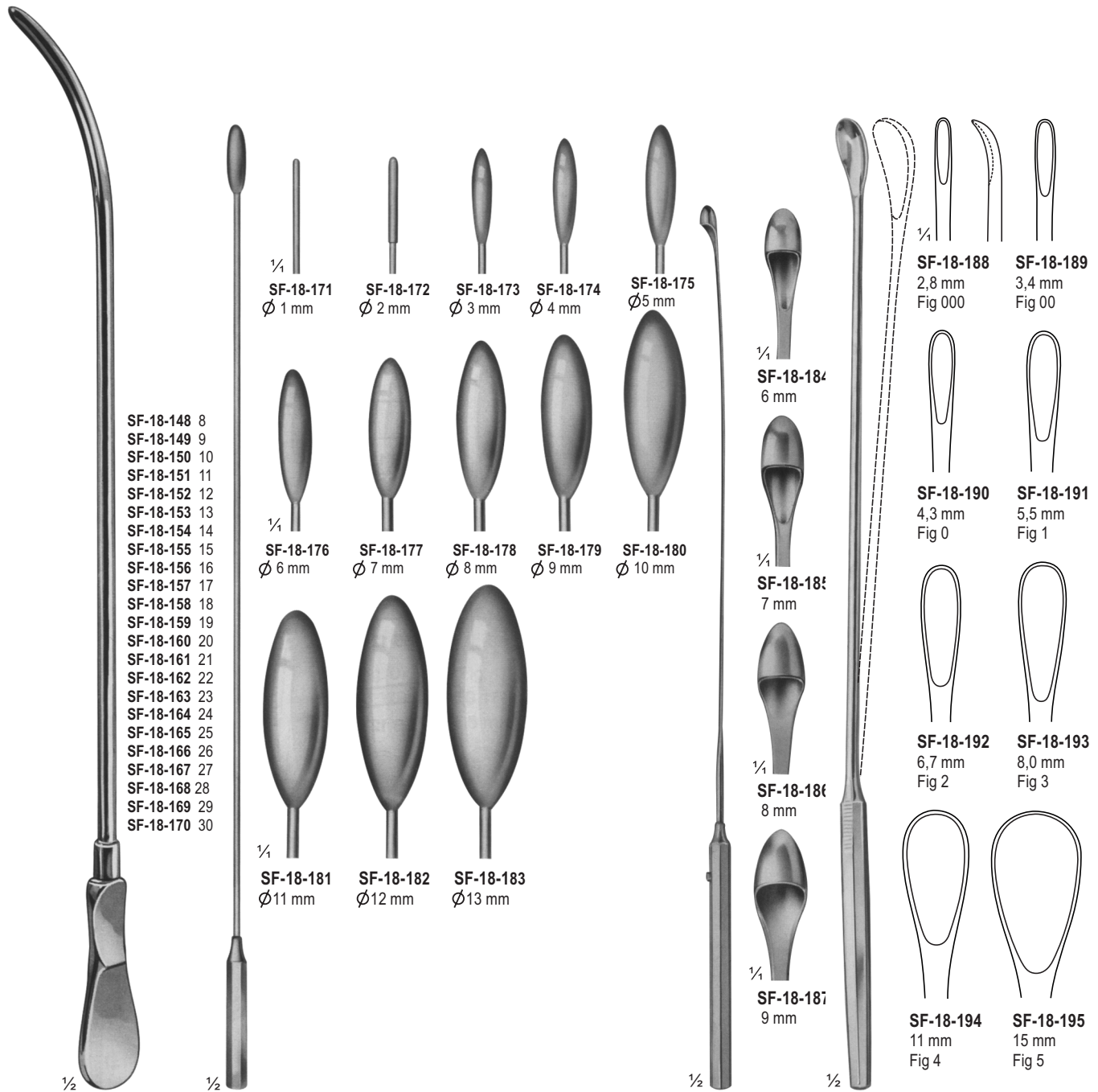

- SF-18-148 8
- SF-18-149 9
- SF-18-150 10
- SF-18-151 11
- SF-18-152 12
- SF-18-153 13
- SF-18-154 14
- SF-18-155 15
- SF-18-156 16
- SF-18-157 17
- SF-18-158 18
- SF-18-159 19
- SF-18-160 20
- SF-18-161 21
- SF-18-162 22
- SF-18-163 23
- SF-18-164 24
- SF-18-165 25
- SF-18-166 26
- SF-18-167 27
- SF-18-168 28
- SF-18-169 29
- SF-18-170 30

**SF-18-148 - SF-18-170**  
DITTEL  
Metall bougies and  
dilating sounds, stiff  
345 mm

**SF-18-171 - SF-18-183**  
BAKES  
Common bile duct  
dilators, malleable  
315 mm, 320 mm

**SF-18-184 - SF-18-187**  
DESJARDINS  
Probes and catch  
with flexible shaft  
300 mm

**SF-18-188 - SF-18-195**  
LUER-KORTE modif  
with malleable shaft  
310 mm





# Surgiforce Instruments



Opposite Surgical Association,  
Malkay Kalan, Marala Road,  
Sialkot-51050 Pakistan.



+92 523 559131



info@surgiforce.com  
sales@surgiforce.com



www.surgiforce.com



## Our Certifications:

ISO 9001

CE Certified

EN 13485:2012

ISO 7153-1

ISO 7151

ISO 17664:2004

ISO 13402

ISO 15223



No.3012922148