

Page
375–395

- Needle Holders
- Suture Instruments
- Ligature Needles
- Guiding Probes

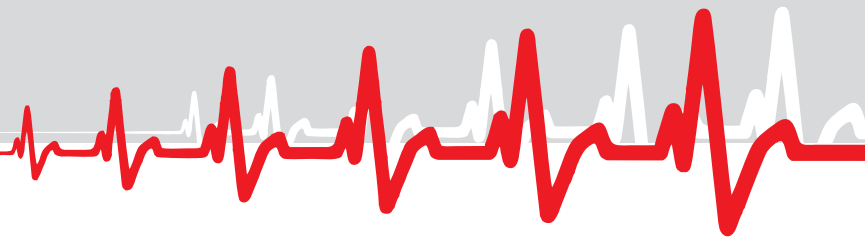

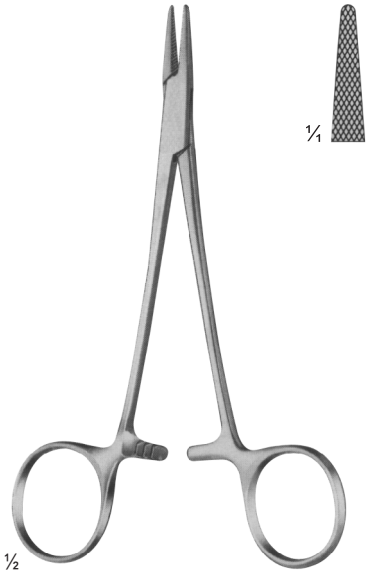

CRILE-MURRAY
SF-17-101
15 cm



CRILE-WOOD
SF-17-102
16 cm

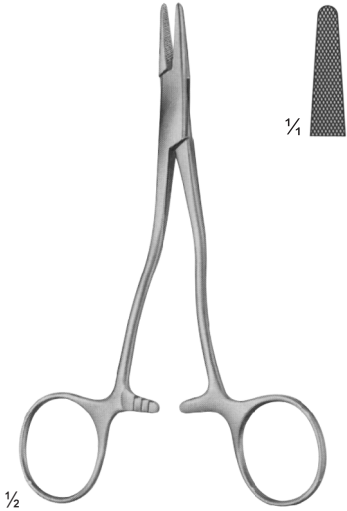

KILNER
SF-17-103
13.5 cm



ADSON
SF-17-104
17.5 cm

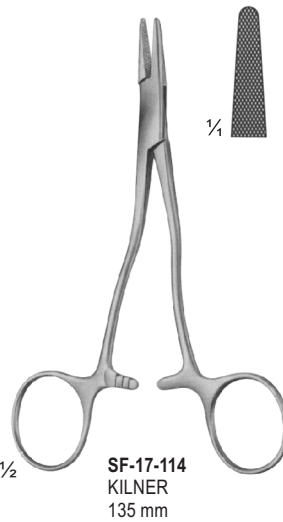
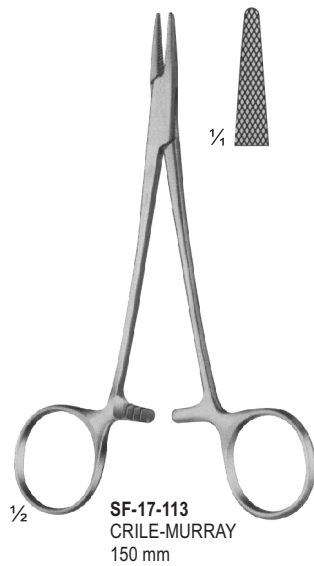
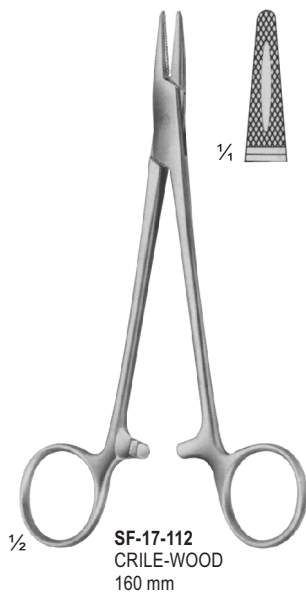
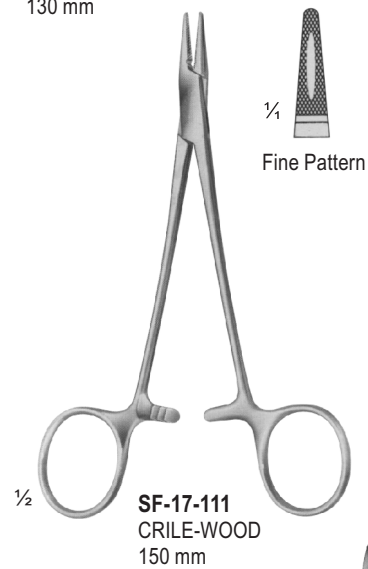
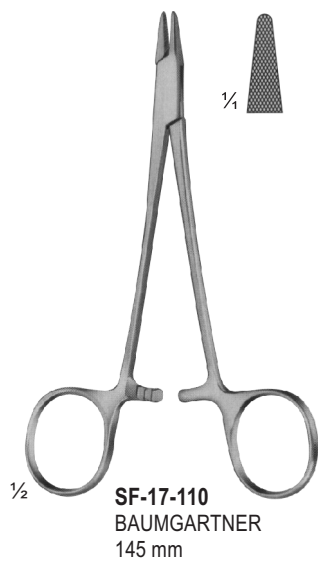
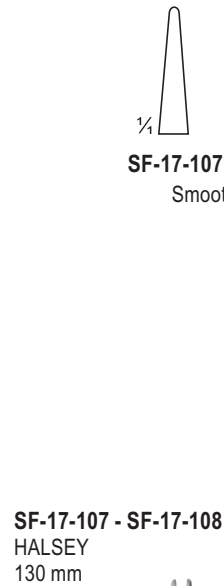
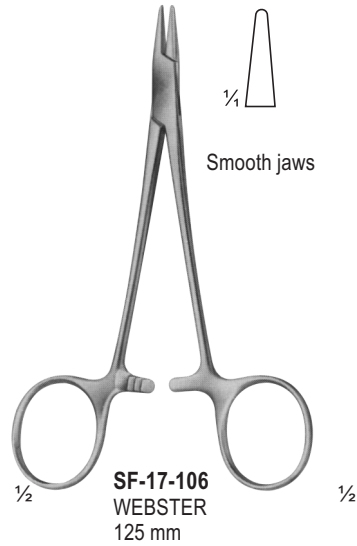

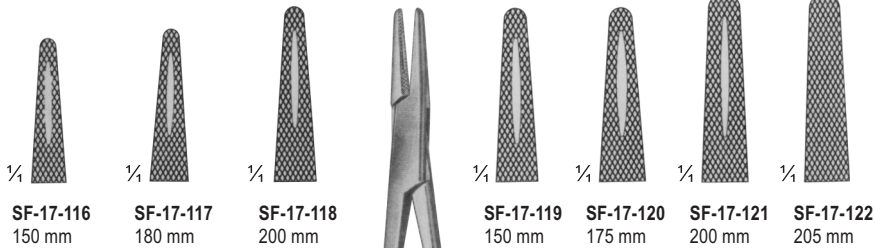

1/2
SF-17-116 - SF-17-118
MAYO-HEGAR
Medium fine patterns

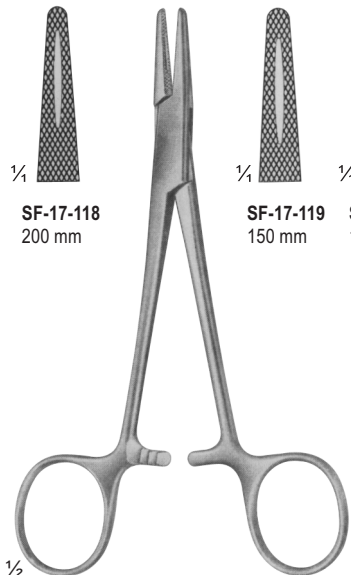

SF-17-119 - SF-17-122
HEGAR
Heavy Patterns

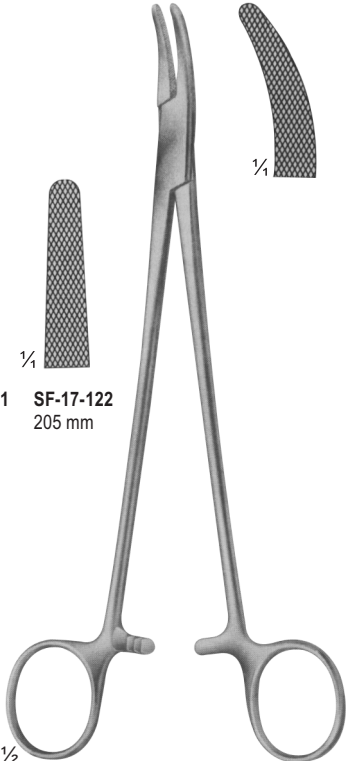

SF-17-123
HEANEY (HEGAR)
200 mm

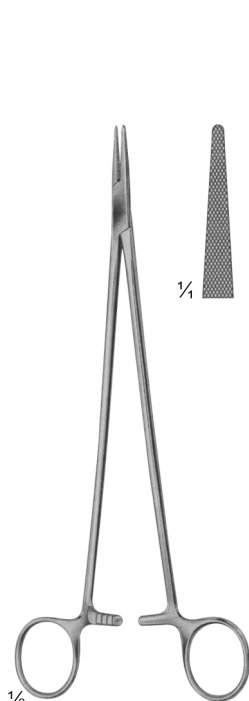

SF-17-124
JAMESON
230 mm

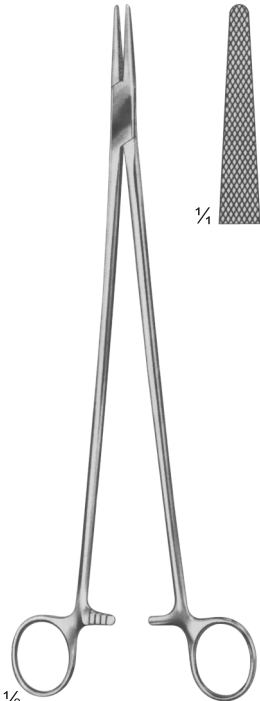

SF-17-125
WANGENSTEEN
275 mm



SF-17-126
MASSON
265 mm

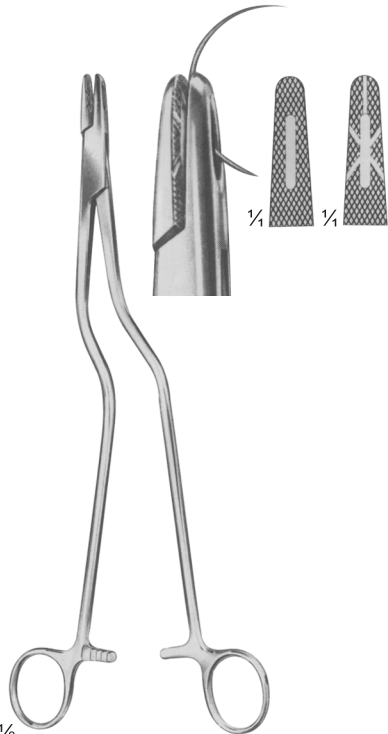

SF-17-127
MASSON-LUETHY
255 mm

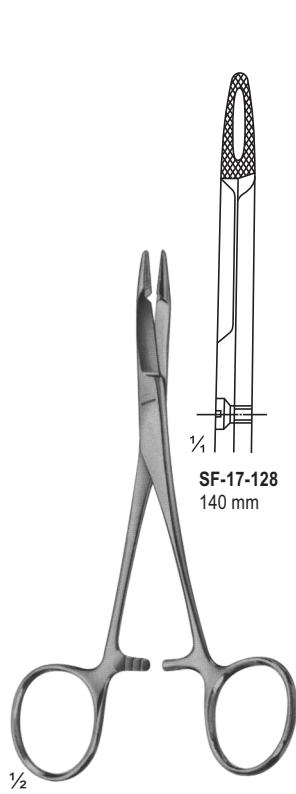

SF-17-128 - SF-17-129
HEGAR-OLSEN
255 mm

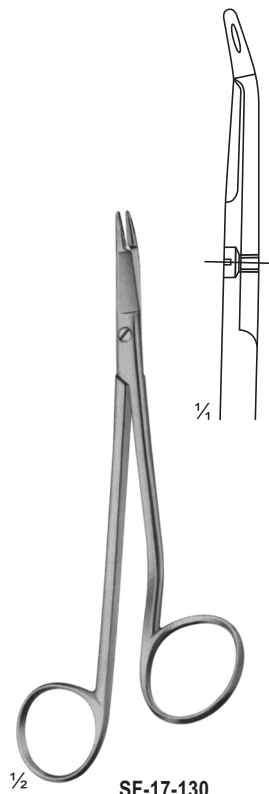
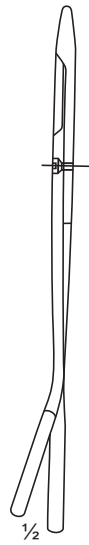
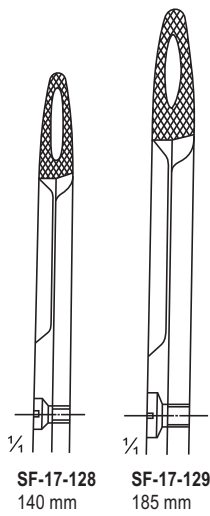

SF-17-130
GILLIES
150 mm

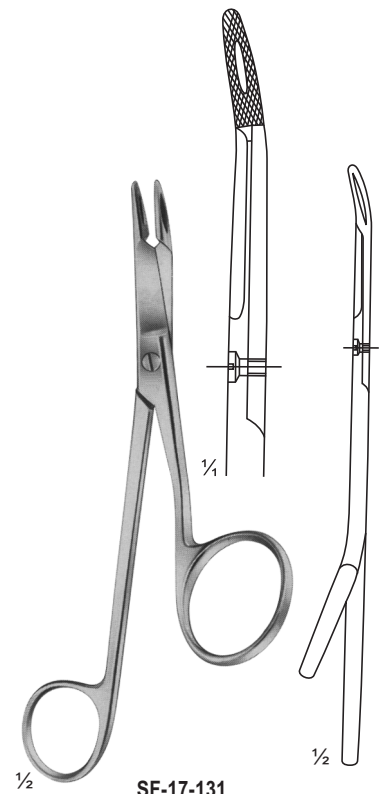
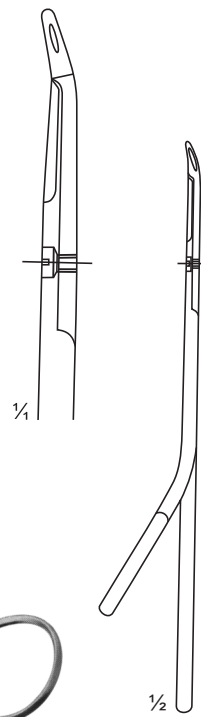

SF-17-131
GILLIES
160 mm

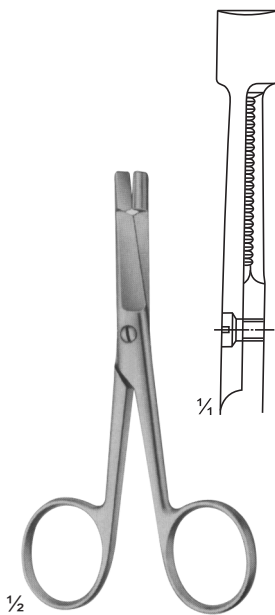
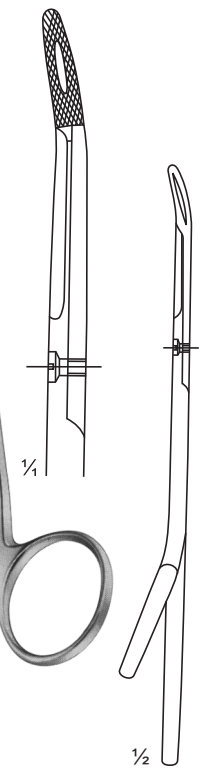

SF-17-132
EISELSBERG
115 mm

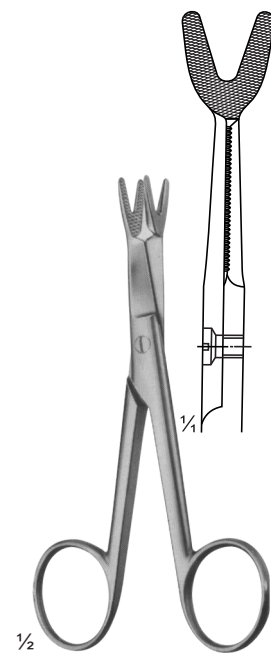
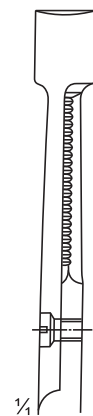

SF-17-133
SCHOEMAKER-LOTH
125 mm

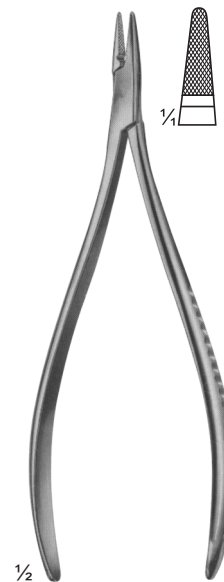
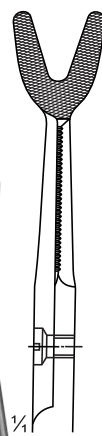

SF-17-134
CRILE
150 mm



SF-17-135
TOENNIS
Elastic pattern for
dura-or intestinal suture
180 mm



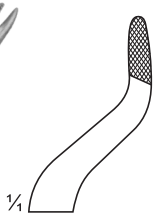
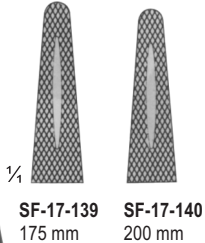
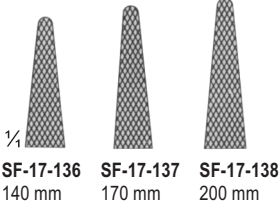

1/2
SF-17-136 - SF-17-138
MATHIEU



SF-17-139 - SF-17-140
MATHIEU-STILLE
Very heavy models



SF-17-141
BOYNTON
125 mm



SF-17-142
EISELSBERG-MATHIEU
For palate suture
195 mm



SF-17-143
MATHIEU-KOCHER

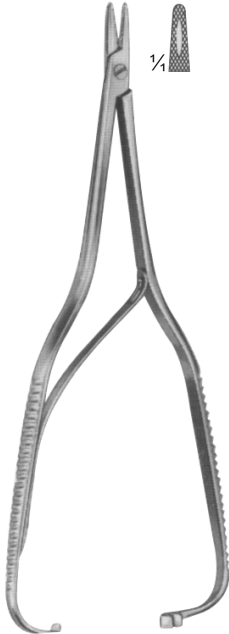

SF-17-144
BOYNTON
125 mm



SF-17-145
MILLIN
Ligature holding forceps
245 mm

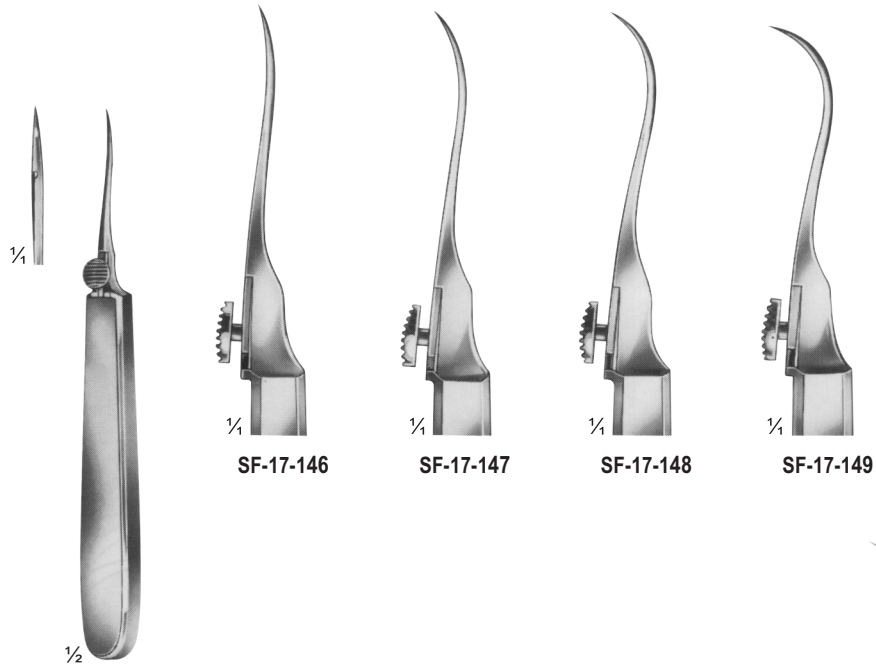

SF-17-146 - SF-17-149
REVERDIN
140 mm



SF-17-150 - SF-17-153
REVERDIN
195 mm

SF-17-154 - SF-17-157
REVERDIN
220 mm



SF-17-158
KRONECKER
for right hand
blunt
155 mm



SF-17-159
KRONECKER
for left hand
blunt
155 mm



SF-17-160
DESCHAMPS
for right hand
steep turn
225 mm



SF-17-161
DESCHAMPS
for left hand
steep turn
225 mm



SF-17-162
DESCHAMPS
for right hand
steep turn blunt
225 mm

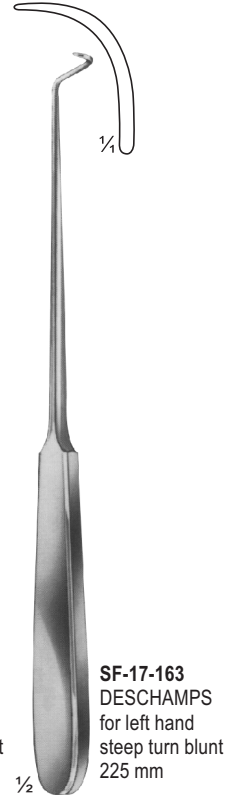

SF-17-163
DESCHAMPS
for left hand
steep turn blunt
225 mm

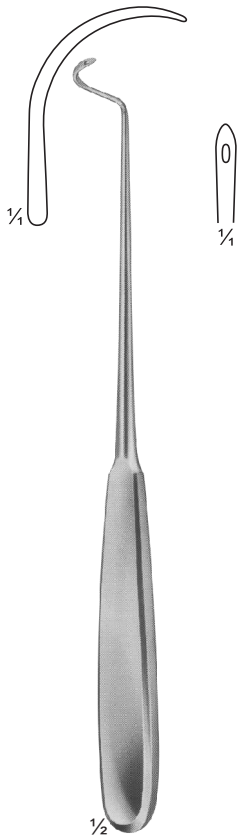

SF-17-164
DESCHAMPS
for right hand
steep turn blunt
230 mm



SF-17-165
DESCHAMPS
for left hand
steep turn blunt
230 mm



SF-17-166
DESCHAMPS
for right hand blunt
215 mm



SF-17-167
DESCHAMPS
for left hand blunt
215 mm

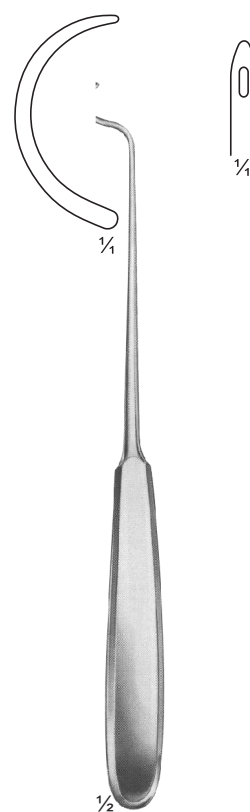

SF-17-168
DESCHAMPS
for right hand blunt
215 mm



SF-17-169
DESCHAMPS
for left hand blunt
215 mm



SF-17-170
HURD
for right hand
sharp
210 mm

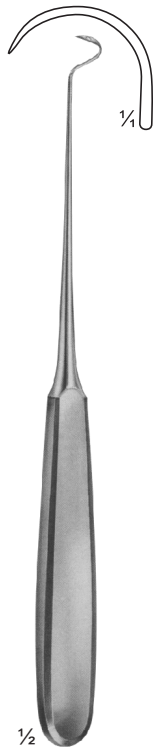

SF-17-171
HURD
for left hand
sharp
210 mm

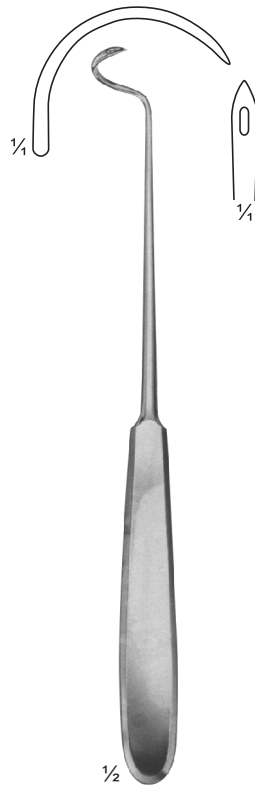

SF-17-172
DESCHAMPS
for right hand
sharp
215 mm



SF-17-173
DESCHAMPS
for left hand
sharp
215 mm



SF-17-174
JONESCO
Needle for wire suture
185 mm

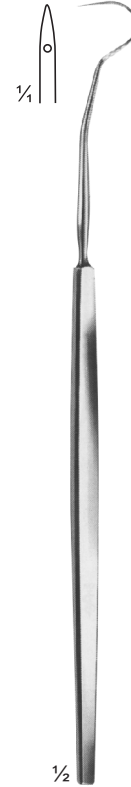

SF-17-175
CLAUS VAN EICKEN
Needle for wire suture
250 mm

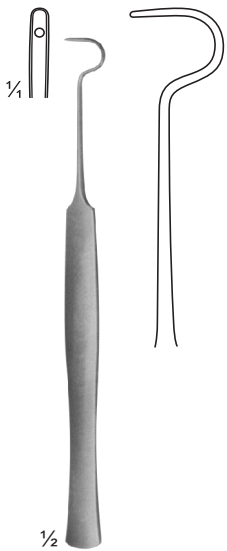

SF-17-176
150 mm

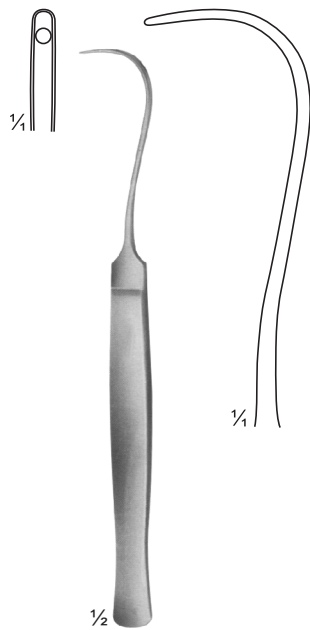

SF-17-177
SYME
170 mm

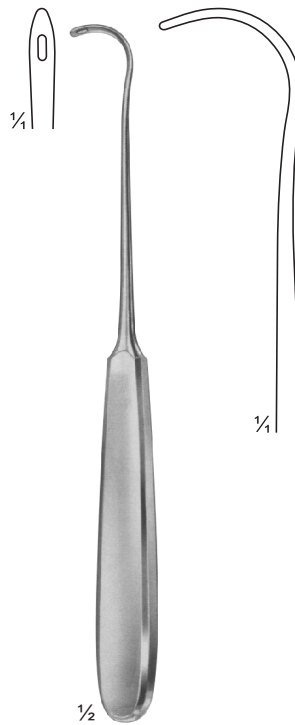

SF-17-178
COOPER
205 mm

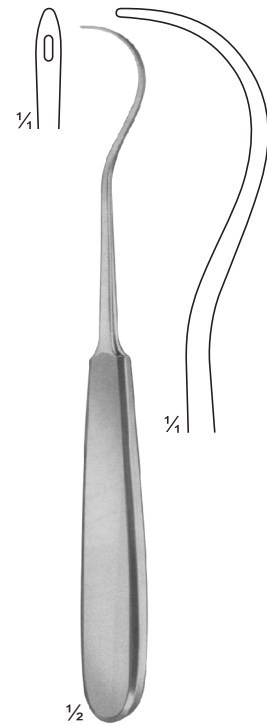

SF-17-179
KOCHER
205 mm

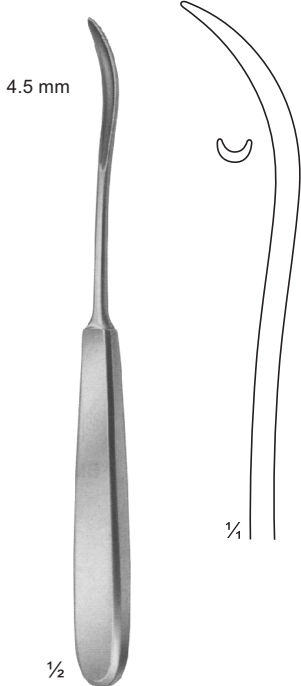

SF-17-180
KOENIG
195 mm

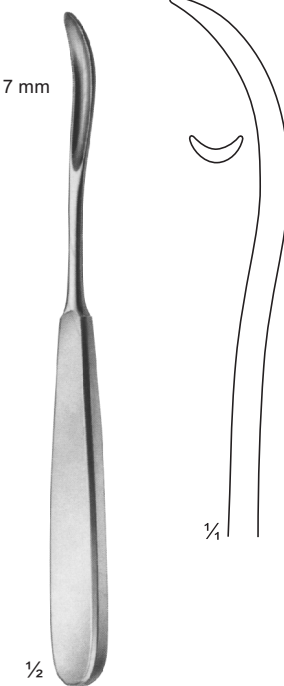

SF-17-181
KOENIG
200 mm

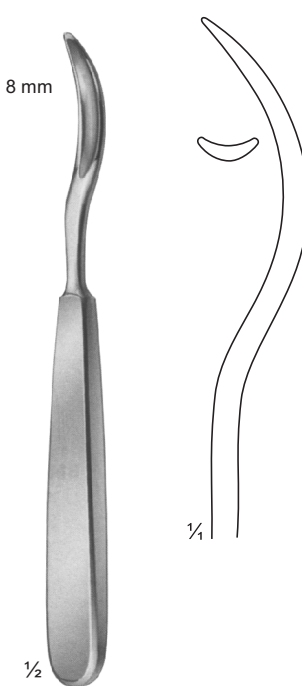

SF-17-182
SCHMIEDEN
185 mm

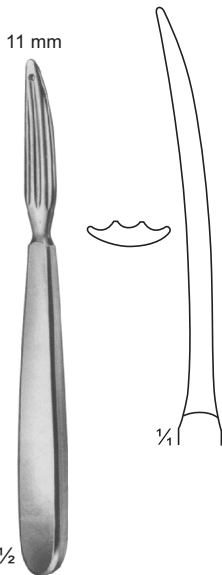

SF-17-183
KOCHER
150 mm

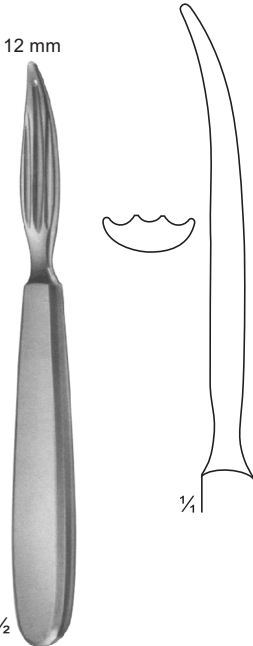

SF-17-184
KOCHER
170 mm

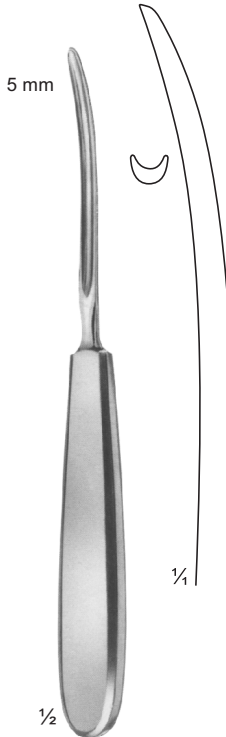

SF-17-185
PAYR
195 mm

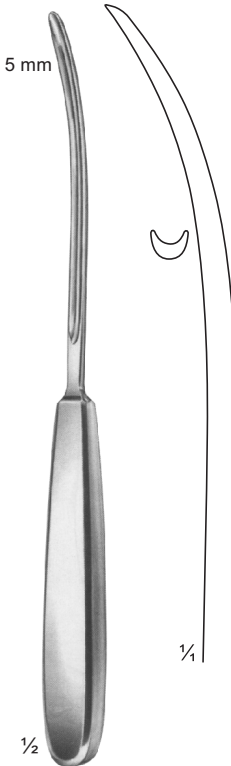

SF-17-186
PAYR 225 mm

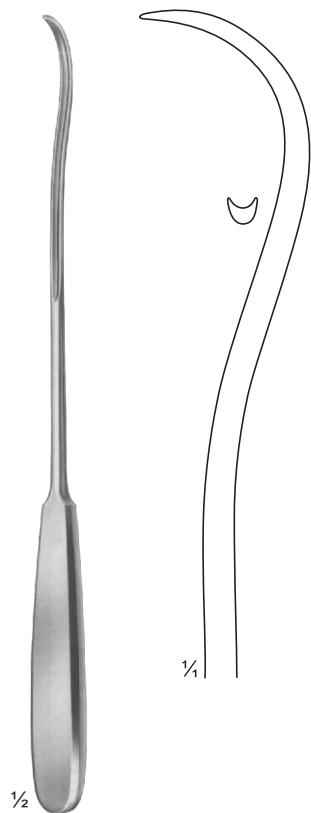

SF-17-187
280 mm

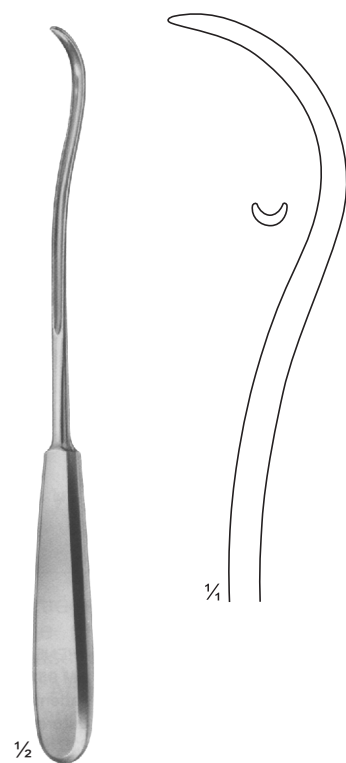

SF-17-188
KIRSCHNER
255 mm

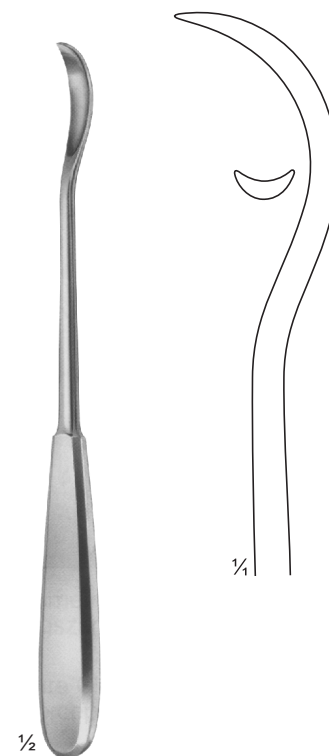

SF-17-189
BRUNNER
245 mm



SF-17-190
Ligature Adjuster
230 mm



SF-17-191
CASPER
Ligature Adjuster
230 mm

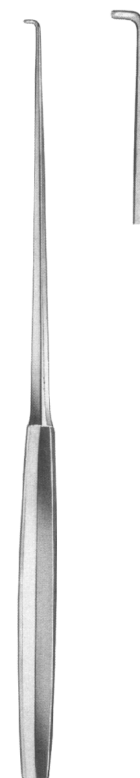

SF-17-192
WIENER MODEL
Suture hook
235 mm

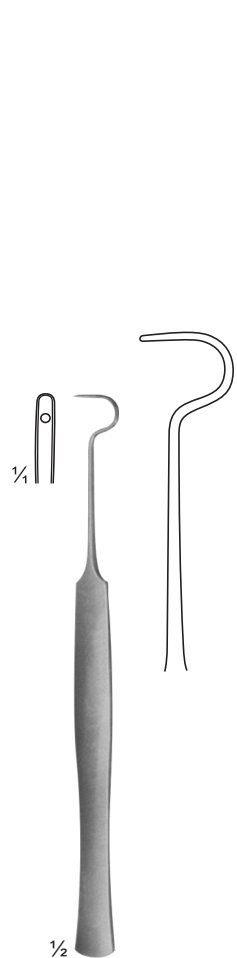

SYME
SF-17-193
15 cm

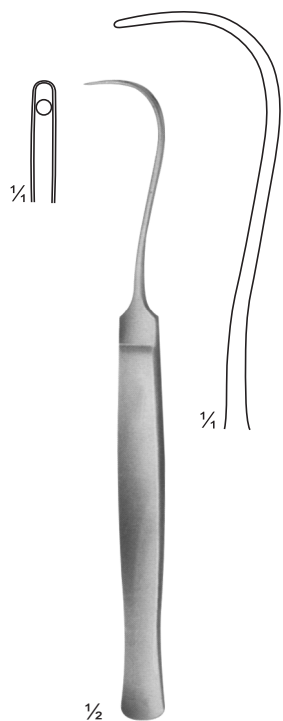

SYME
SF-17-194
17 cm

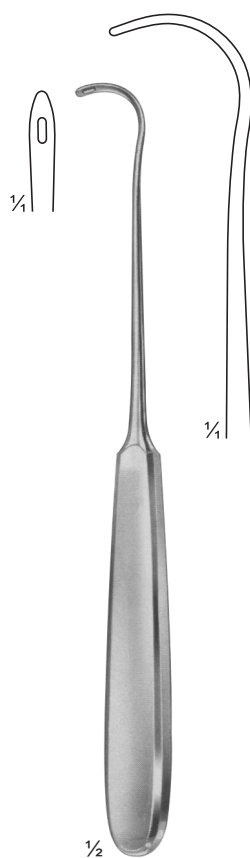

COOPER
SF-17-195
20.5 cm

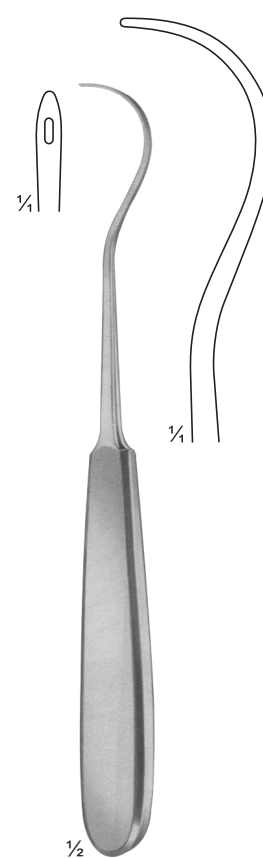

KOCHER
SF-17-196
20.5 cm



CLAUS VAN EICKEN
Needle for wire suture
SF-17-197
25 cm

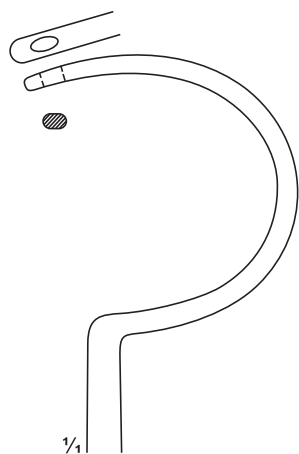

DEMEL
Wire guides
SF-17-198 - SF-17-200
SF-17-198 275 mm
SF-17-199 285 mm
SF-17-200 305 mm

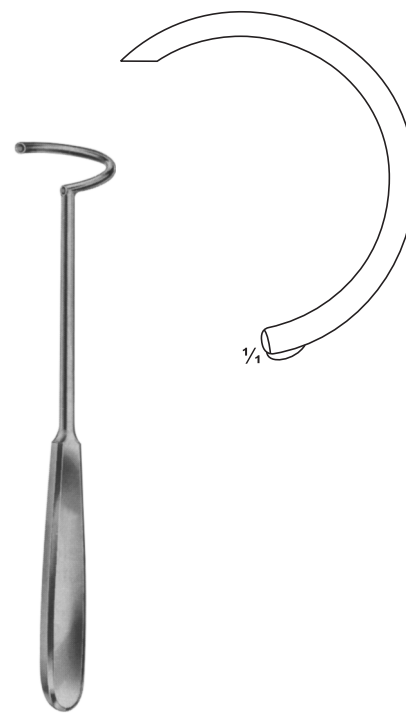

SF-17-201
225 mm

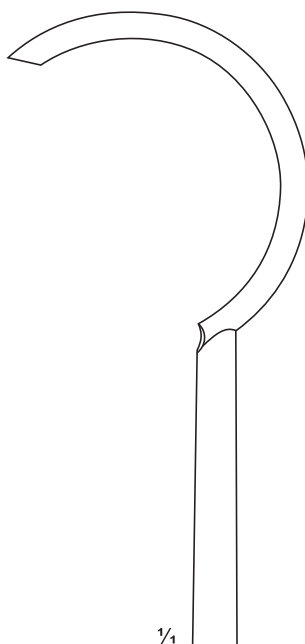

SF-17-202 - SF-17-203
SF-17-202 240 mm
SF-17-203 270 mm



KALT
SF-17-204
13.5 cm



DIETHRICH
SF-17-205 - SF-17-209
SF-17-205 16 cm
SF-17-206 18 cm
SF-17-207 20 cm
SF-17-208 23 cm
SF-17-209 26 cm



WEBSTER
SF-17-210
13 cm



DERF
SF-17-211
12 cm



HEGAR-BAUMGARTNER
SF-17-212 - SF-17-213
SF-17-212 12.5 cm
SF-17-213 14 cm

SF-17-212
12.5 cm

SF-17-213
14 cm



WEBSTER
SF-17-214
13 cm

NEEDLE HOLDERS WITH TUNGSTEN CARBIDE INSERTS

www.surgiforce.com



HALSEY
SF-17-215 - SF-17-216
13 cm



SF-17-215



SF-17-216



CRILE-WOOD
SF-17-217 - SF-17-218



SF-17-217
15 cm



SF-17-218
18 cm

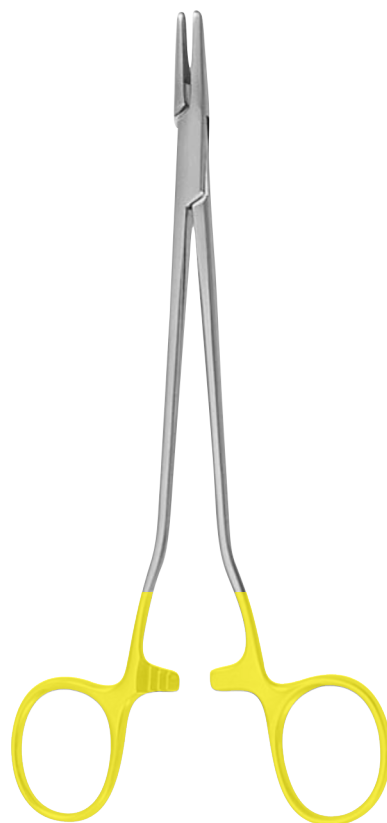

SAROT
SF-17-219 - SF-17-221



SF-17-219
18.0 cm



SF-17-220
20.0 cm



SF-17-221
26.0 cm



MAYO-HEGAR
SF-17-222 - SF-17-227
SF-17-222 16 cm
SF-17-223 18 cm
SF-17-224 20 cm
SF-17-225 24 cm
SF-17-226 26 cm
SF-17-227 30 cm

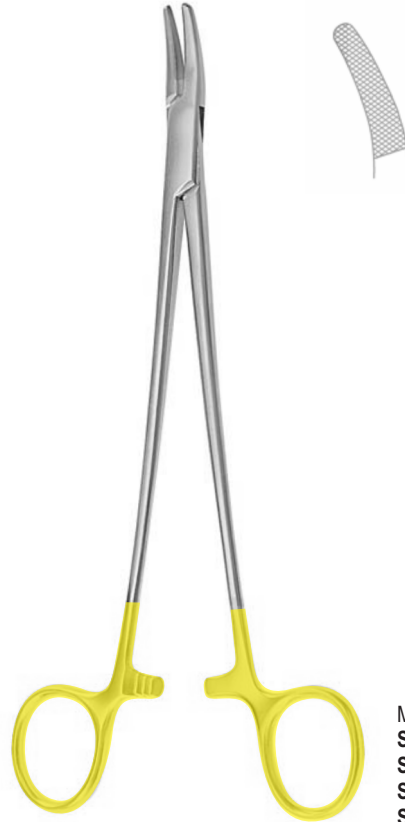

MAYO-HEGAR (HEANEY)
SF-17-228 - SF-17-230
SF-17-228 20 cm
SF-17-229 24 cm
SF-17-230 26 cm

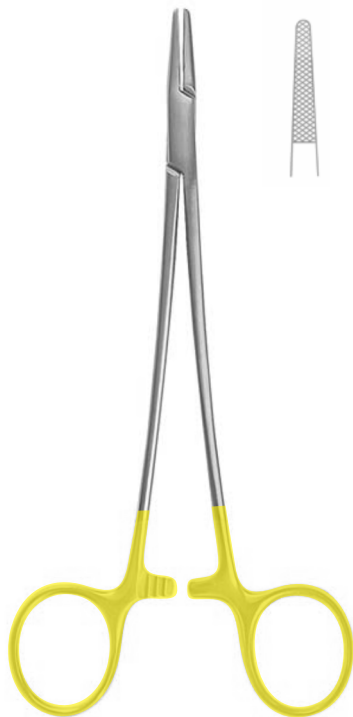

DE BAKEY
SF-17-231 - SF-17-236
SF-17-231 18 cm
SF-17-232 20 cm
SF-17-233 23 cm
SF-17-234 26 cm
SF-17-235 31 cm
SF-17-236 37 cm

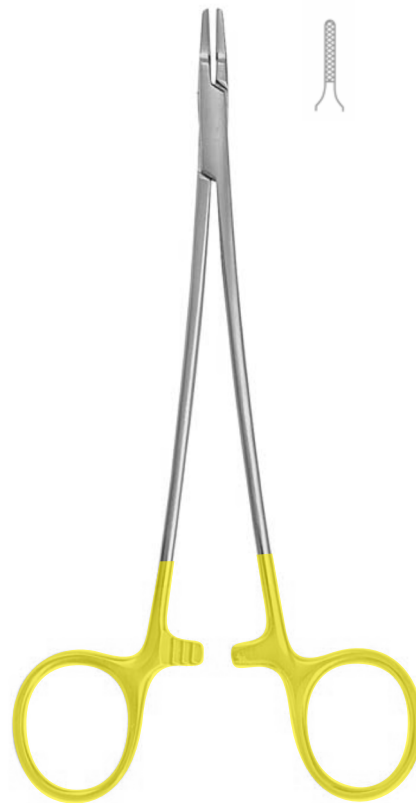

RYDER-VASCULAR
SF-17-237 - SF-17-242
SF-17-237 13 cm
SF-17-238 15 cm
SF-17-239 18 cm
SF-17-240 20 cm
SF-17-241 23 cm
SF-17-242 26 cm

NEEDLE HOLDERS WITH TUNGSTEN CARBIDE INSERTS

www.surgiforce.com



RYDER
SF-17-243 - SF-17-248
SF-17-243 13 cm
SF-17-244 15 cm
SF-17-245 18 cm
SF-17-246 20 cm
SF-17-247 23 cm
SF-17-248 26 cm

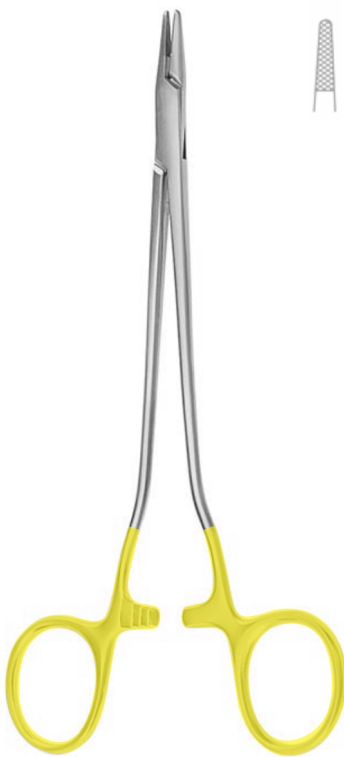

SCHWEDISCHES MODELL
SF-17-249 - SF-17-251
SF-17-249 15 cm
SF-17-250 17 cm
SF-17-251 20 cm

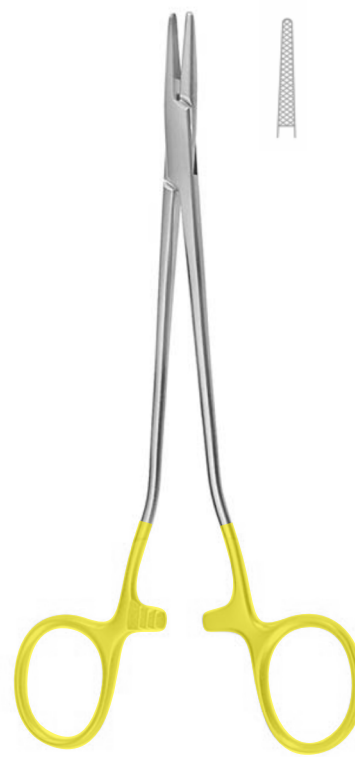

MAYO-HEGAR (HEANEY)
SF-17-252 - SF-17-255
SF-17-252 14 cm
SF-17-253 18 cm
SF-17-254 20 cm
SF-17-255 23 cm



FINOCCHIETTO
SF-17-256
 27 cm



MASSON
SF-17-257
 27 cm



WANGENSTEEN
SF-17-258
 27 cm

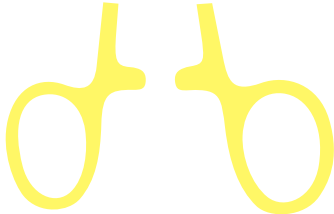

BOZEMANN
SF-17-259 - SF-17-261
SF-17-259 20 cm
SF-17-260 24 cm
SF-17-261 26 cm

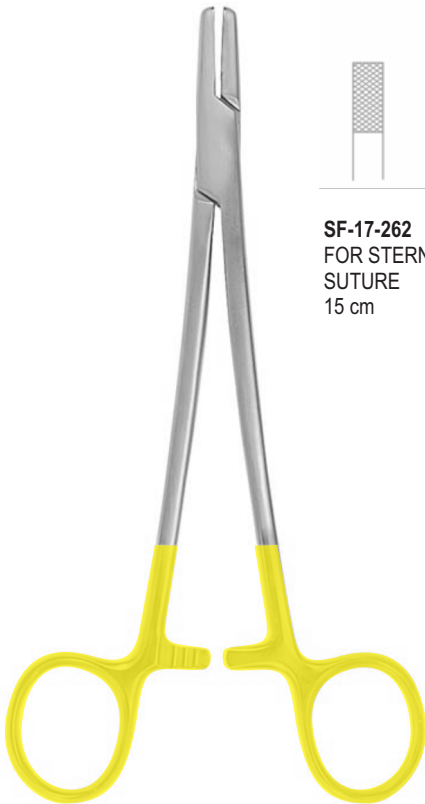
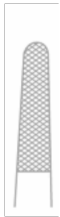

BERRY STERNAL
SF-17-262 - SF-17-263



SF-17-262
FOR STERNUM
SUTURE
 15 cm

SF-17-263
WIRE TWISTER
 20 cm



HEGAR
SF-17-264 - SF-17-265
SF-17-264 20 cm
SF-17-265 24 cm





STRATTE
SF-17-266 - SF-17-267
SF-17-266 22 cm
SF-17-267 23 cm



GILLIES
SF-17-268
16 cm



OLSEN-HEGAR
SF-17-269 - SF-17-271
SF-17-269 14 cm
SF-17-270 17 cm
SF-17-271 18 cm



TOENNIS
SF-17-272
18 cm



LICHTENBERG
SF-17-273 - SF-17-274
SF-17-273 17 cm
SF-17-274 20 cm



MATHIEU-KOCHER
SF-17-275 - SF-17-277
SF-17-275 14 cm
SF-17-276 17 cm
SF-17-277 20 cm



MATHIEU
SF-17-278 - SF-17-280
SF-17-278 14 cm
SF-17-279 17 cm
SF-17-280 20 cm



MATHIEU
SF-17-281 - SF-17-283
SF-17-281 14 cm
SF-17-282 17 cm
SF-17-283 20 cm



ZWEIFEL
SF-17-284 - SF-17-285
SF-17-284 20 cm
SF-17-285 23 cm



LANGENBECK
SF-17-286 - SF-17-288
SF-17-286 18 cm
SF-17-287 20 cm
SF-17-288 23 cm



CASTROVIEJO
SF-17-289 - SF-17-292
14.5 cm



SF-17-289



SF-17-290



SF-17-291



SF-17-292



CASTROVIEJO
SF-17-293 - SF-17-296
18 cm



SF-17-293



SF-17-294



SF-17-295



SF-17-296



BARRAQUER
SF-17-297 - SF-17-300
14.5 cm



SF-17-297



SF-17-298



SF-17-299



SF-17-300



HEPP SCHEIDEL
SF-17-301
18 cm



Surgiforce Instruments



Opposite Surgical Association,
Malkay Kalan, Marala Road,
Sialkot-51050 Pakistan.



+92 523 559131



info@surgiforce.com
sales@surgiforce.com



www.surgiforce.com



Our Certifications:

ISO 9001

CE Certified

EN 13485:2012

ISO 7153-1

ISO 7151

ISO 17664:2004

ISO 13402

ISO 15223



No.3012922148