

Surgiforce
Instruments

Page
254–288

- Wound Retractors

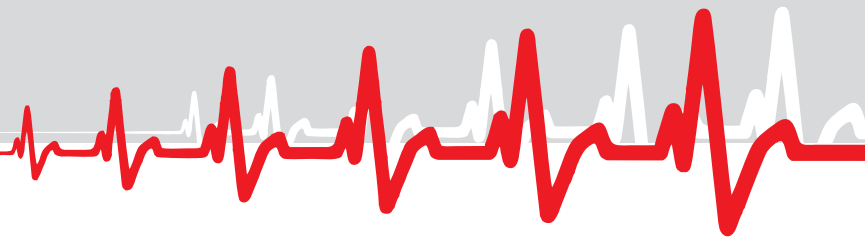

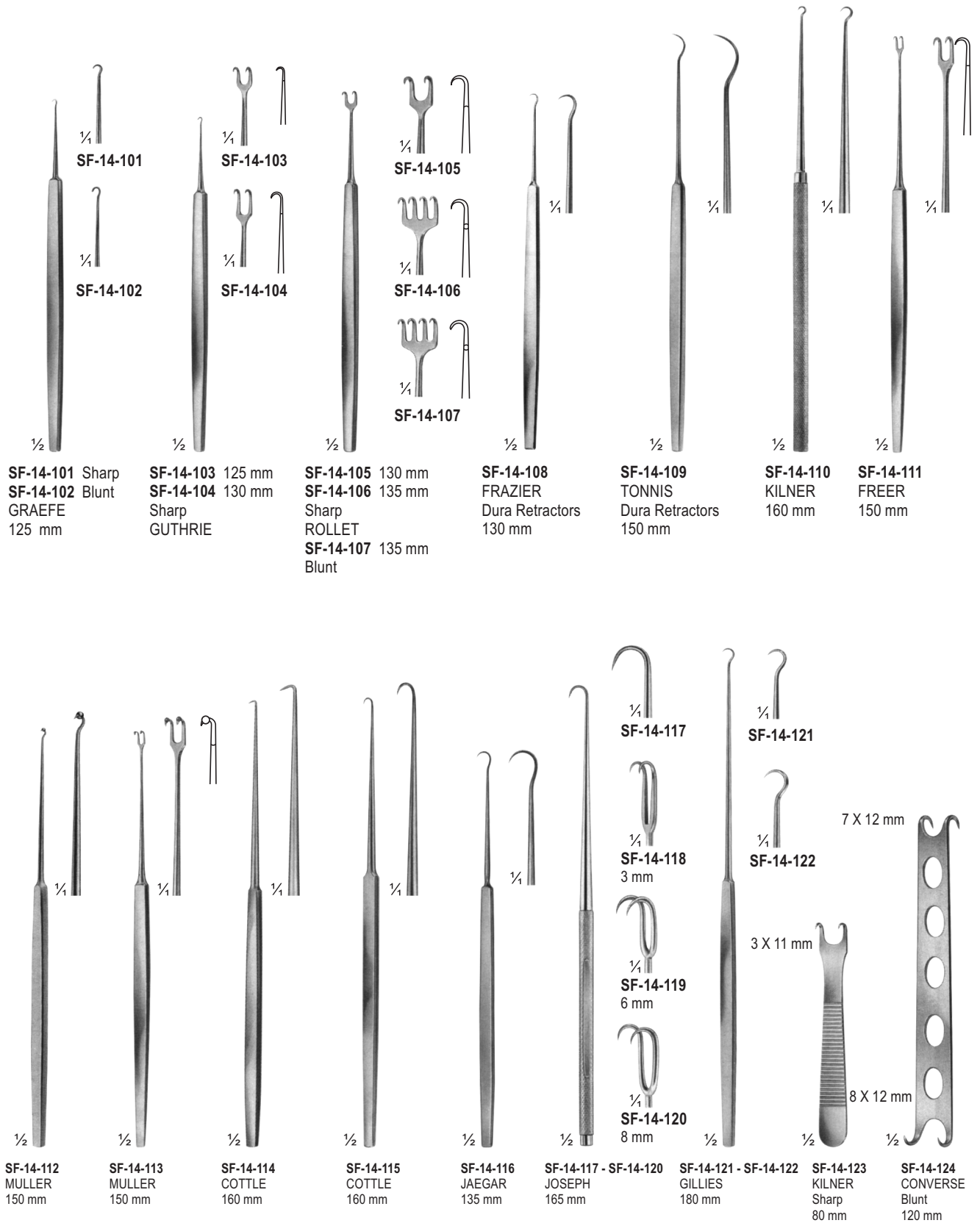

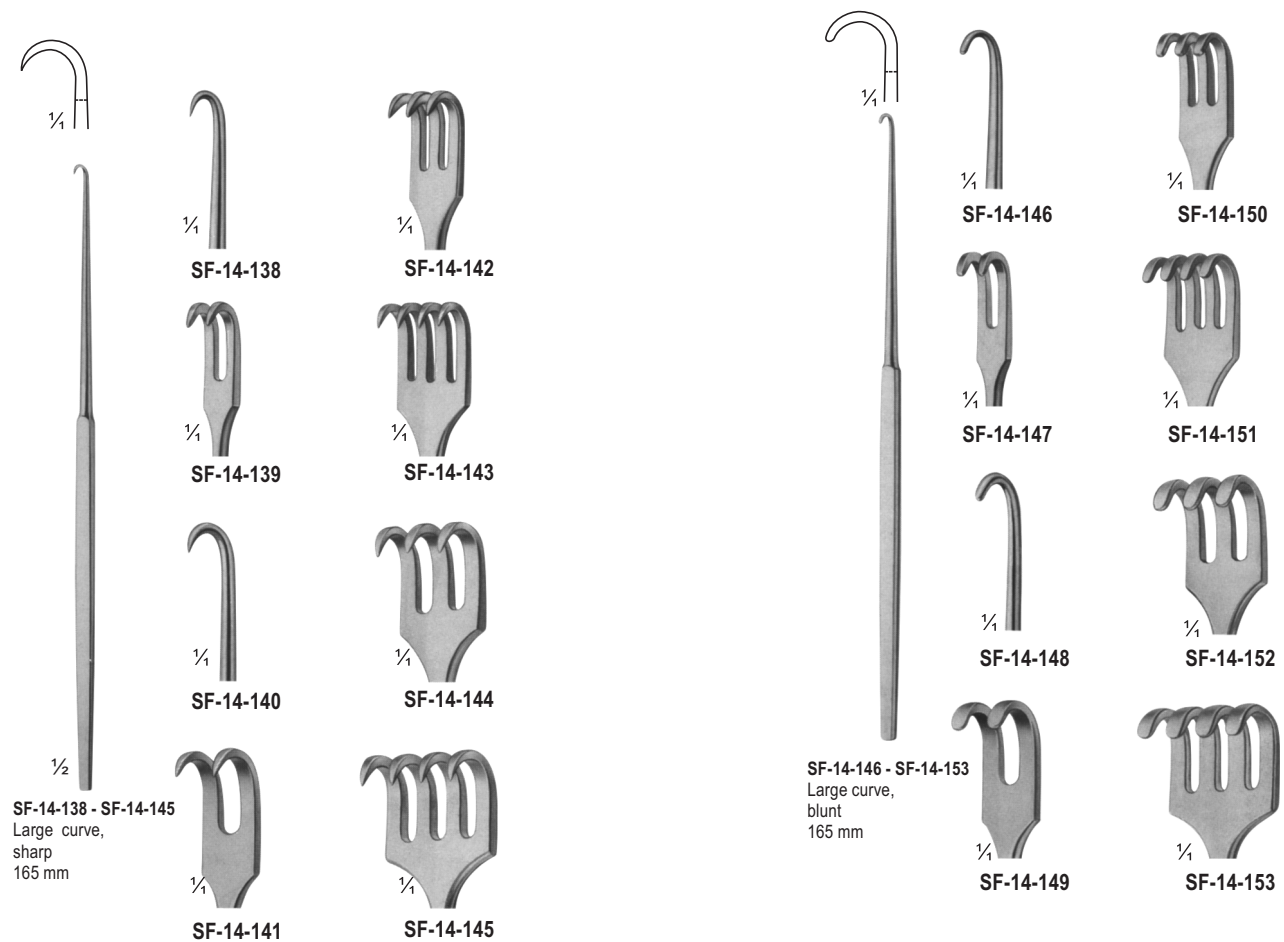
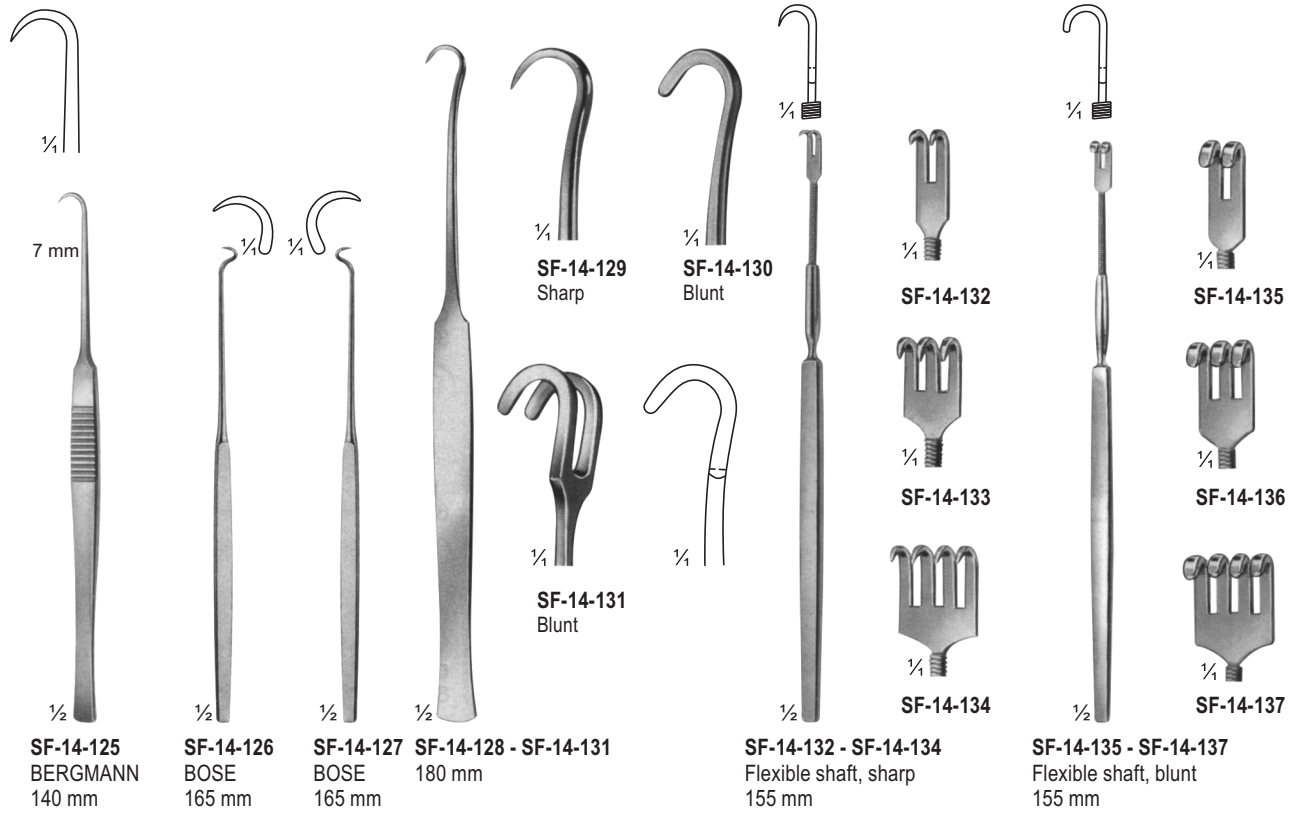

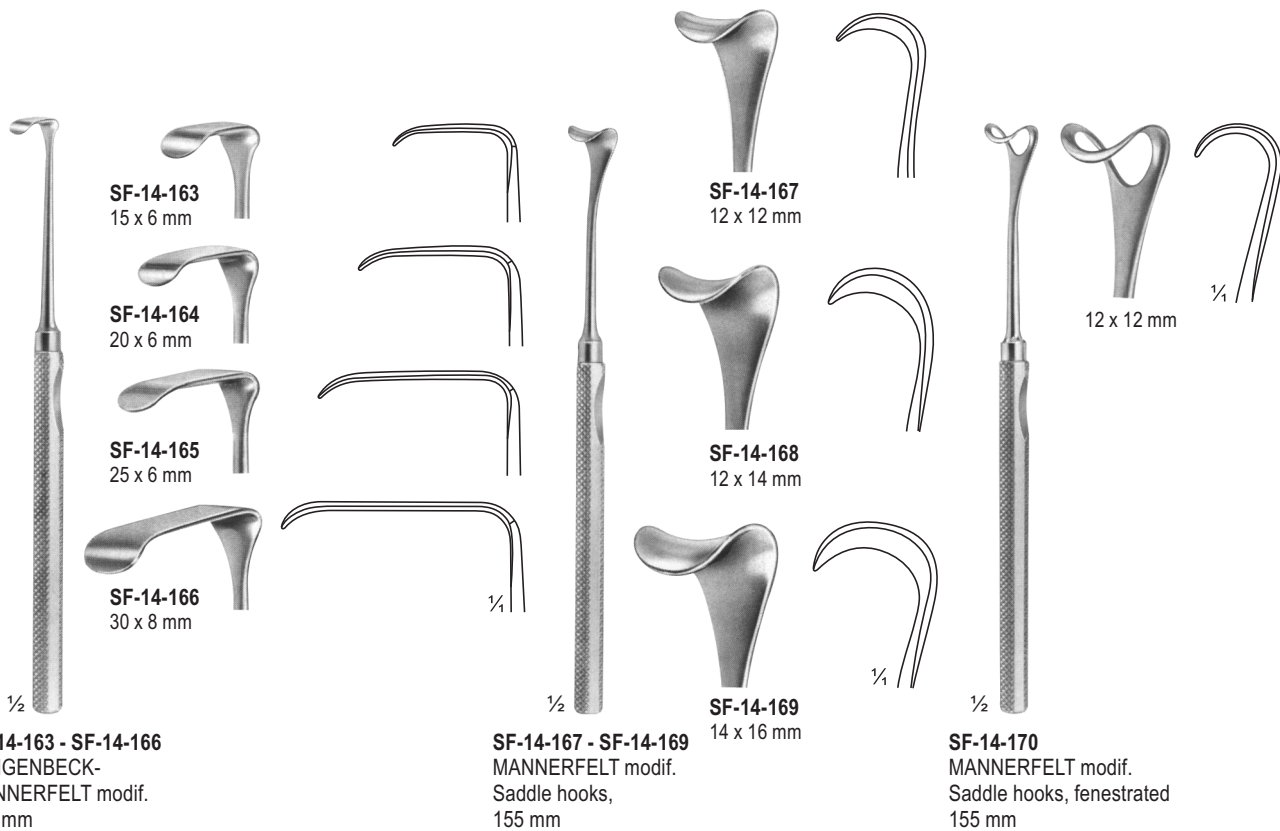
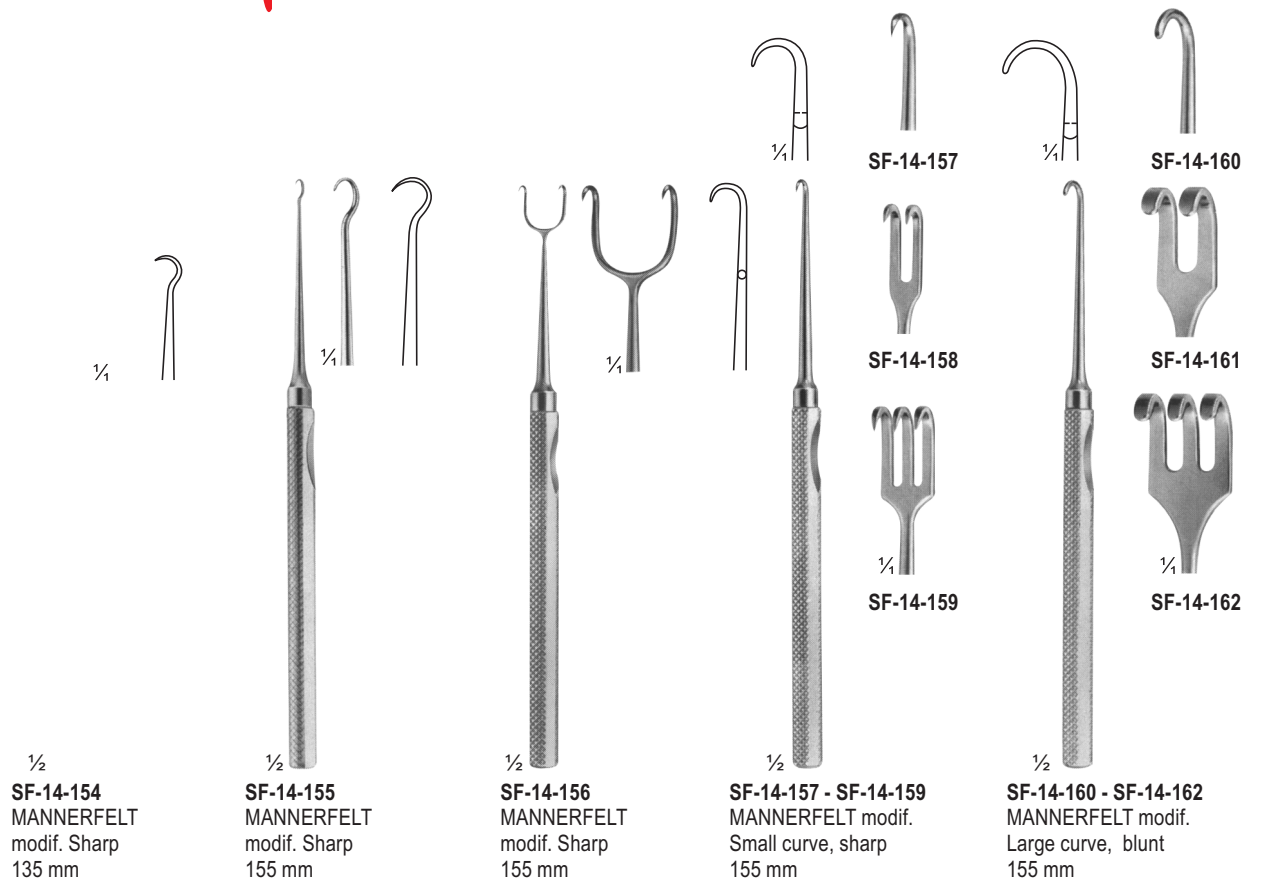

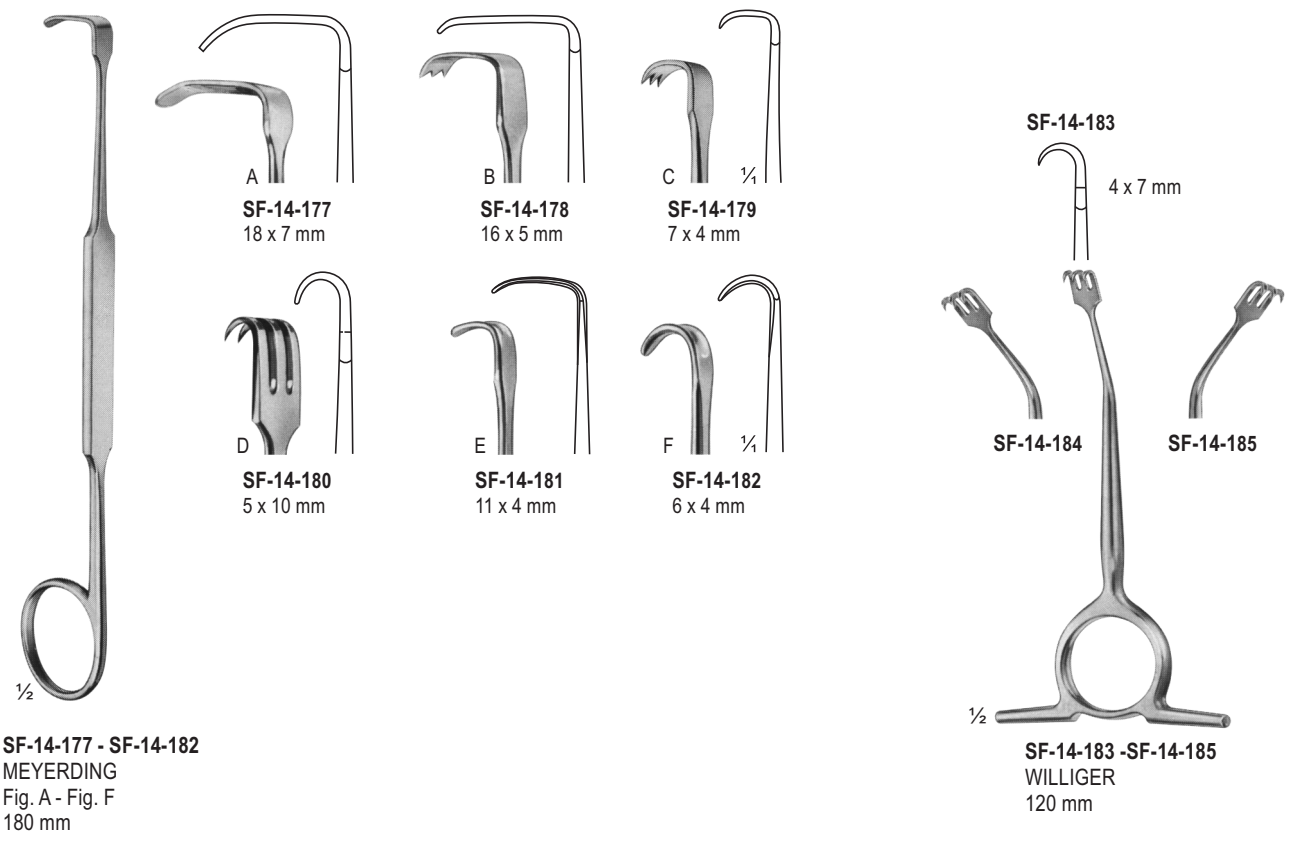
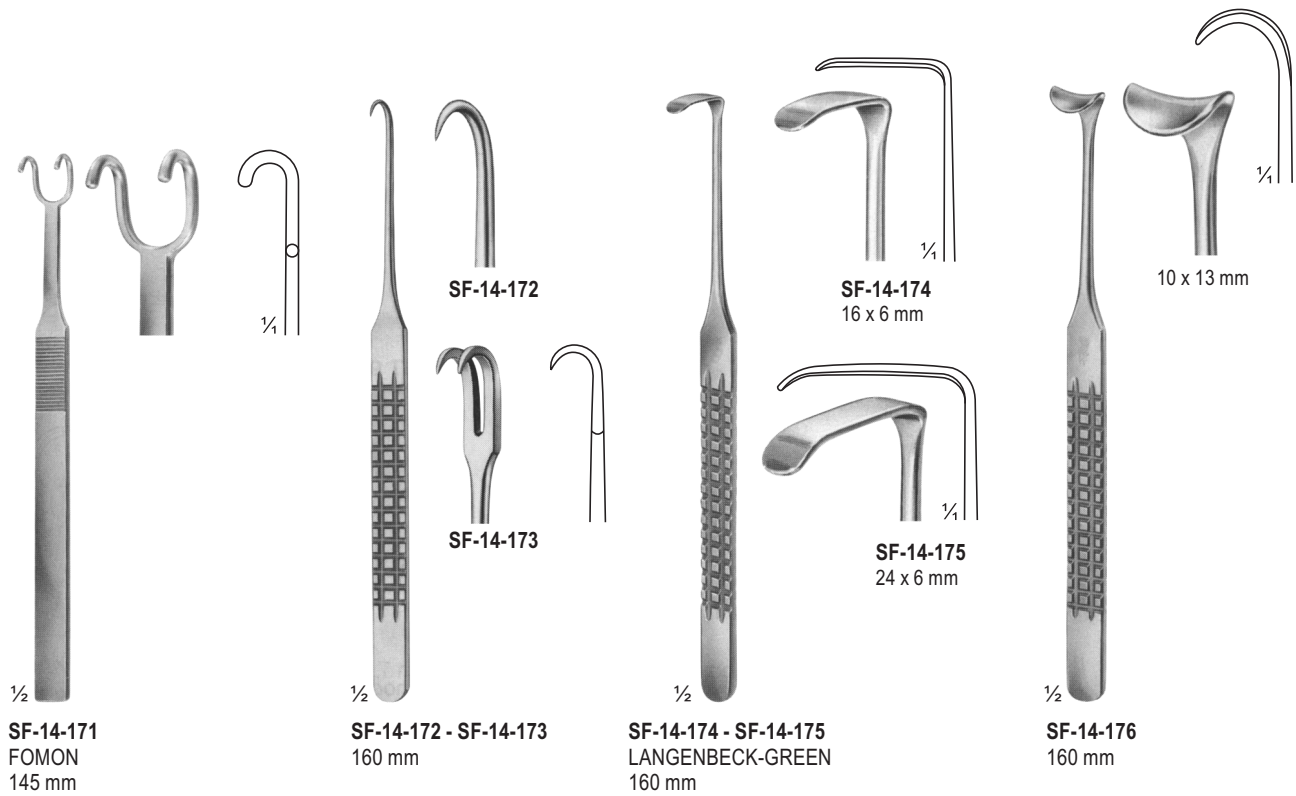



SF-14-186
EMMET
Fistula hook
220 mm

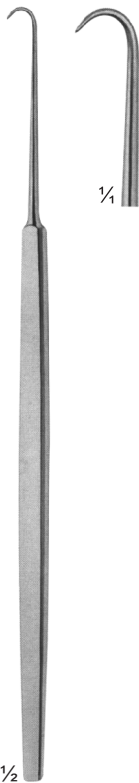

SF-14-187
SIMON
Fistula hook
220 mm



SF-14-188
SIMON
Fistula hook
220 mm



SF-14-189
LANGE
Fistula hook
230 mm

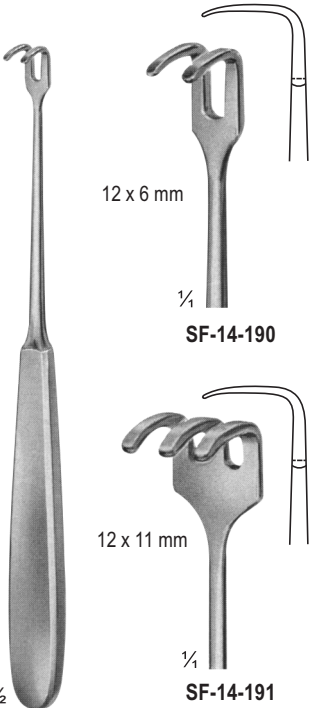

SF-14-190 - SF-14-191
Tendon hooks
175 mm

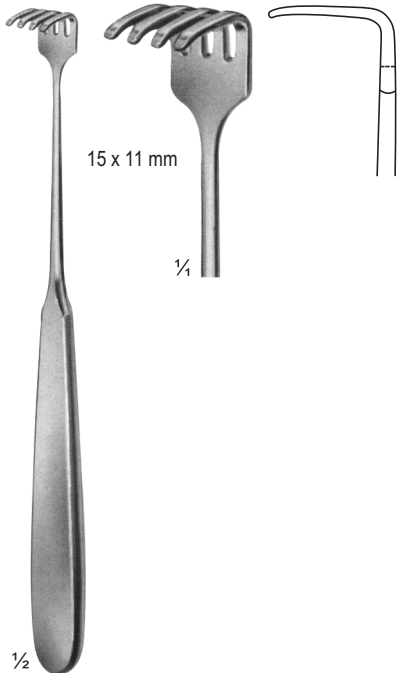

SF-14-192
KLAPP
Tendon hooks
175 mm

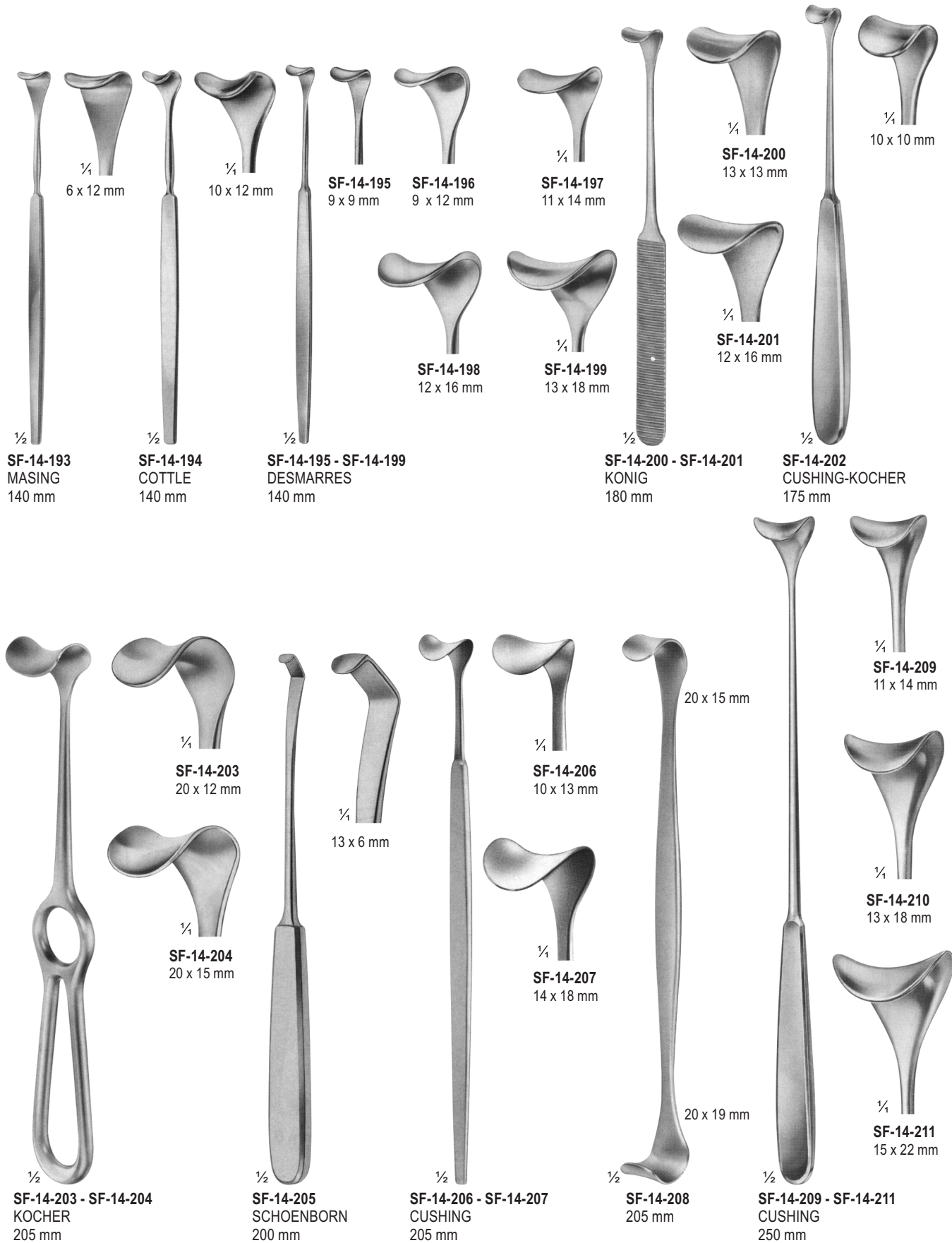

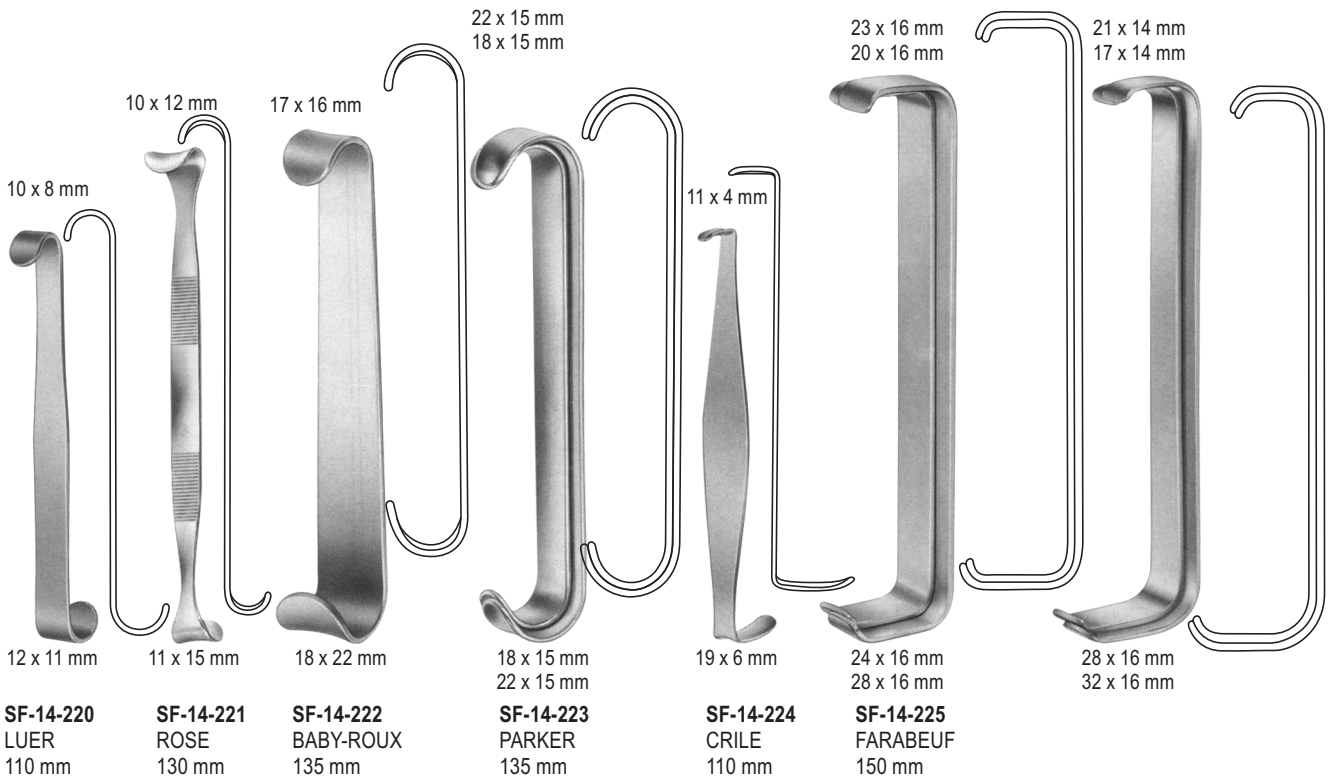
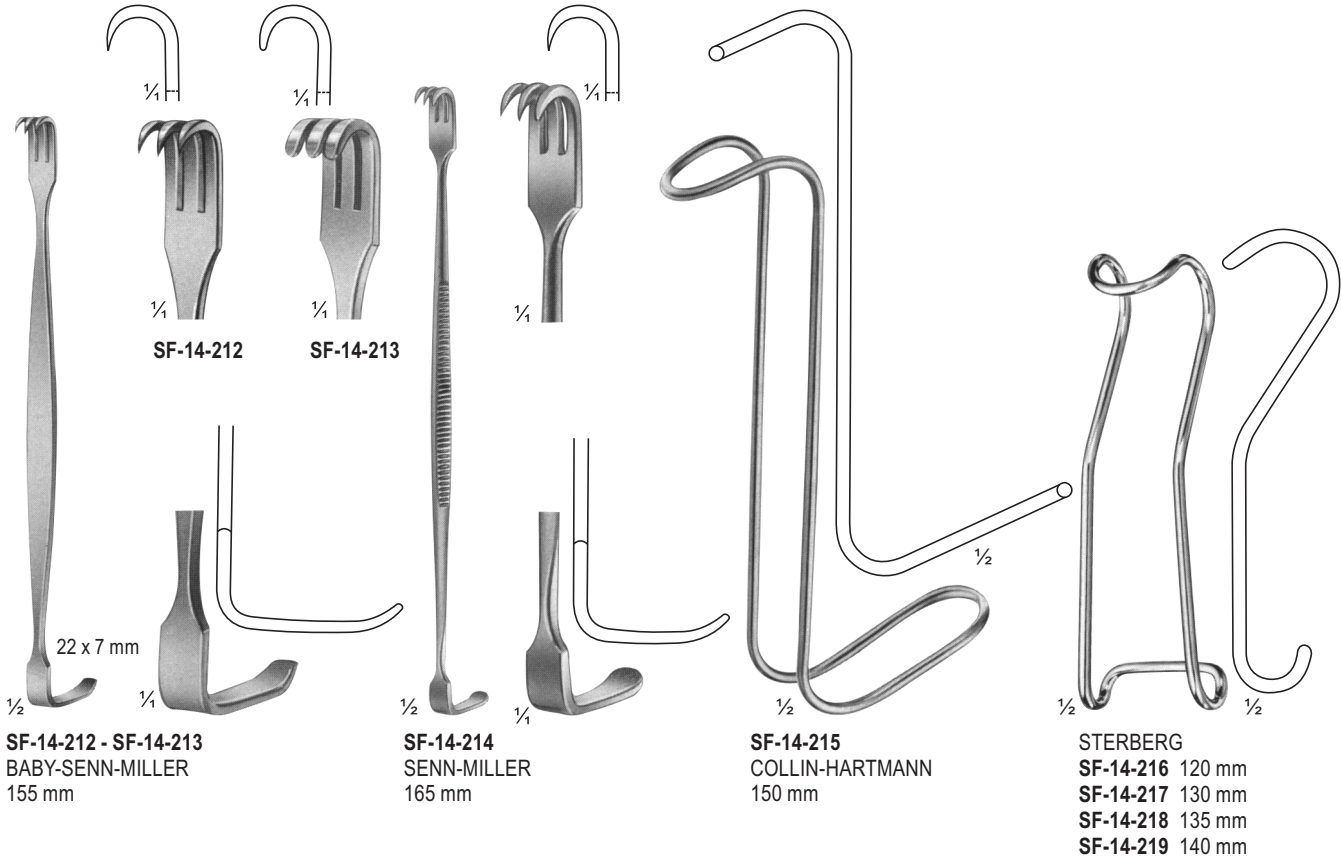

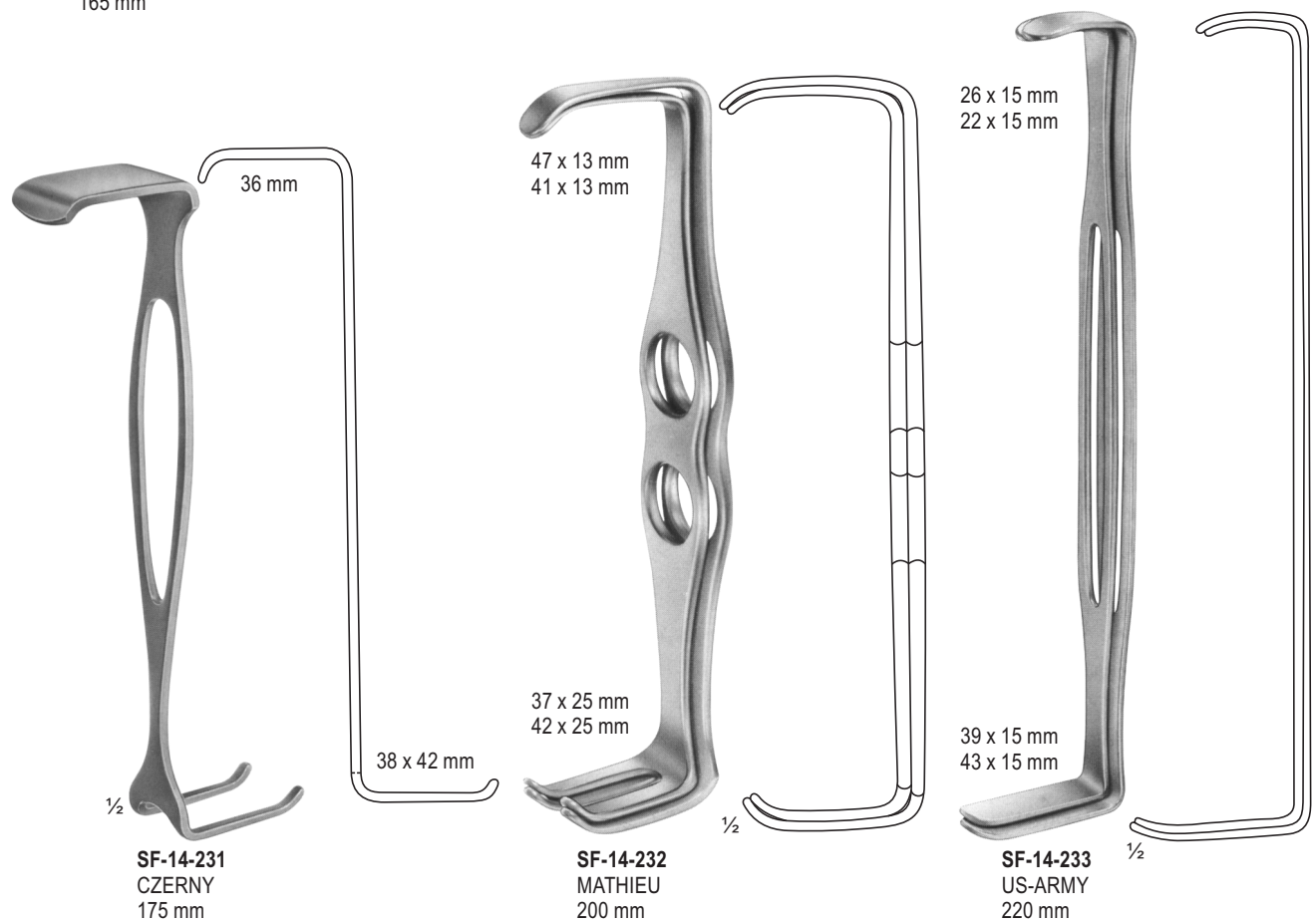
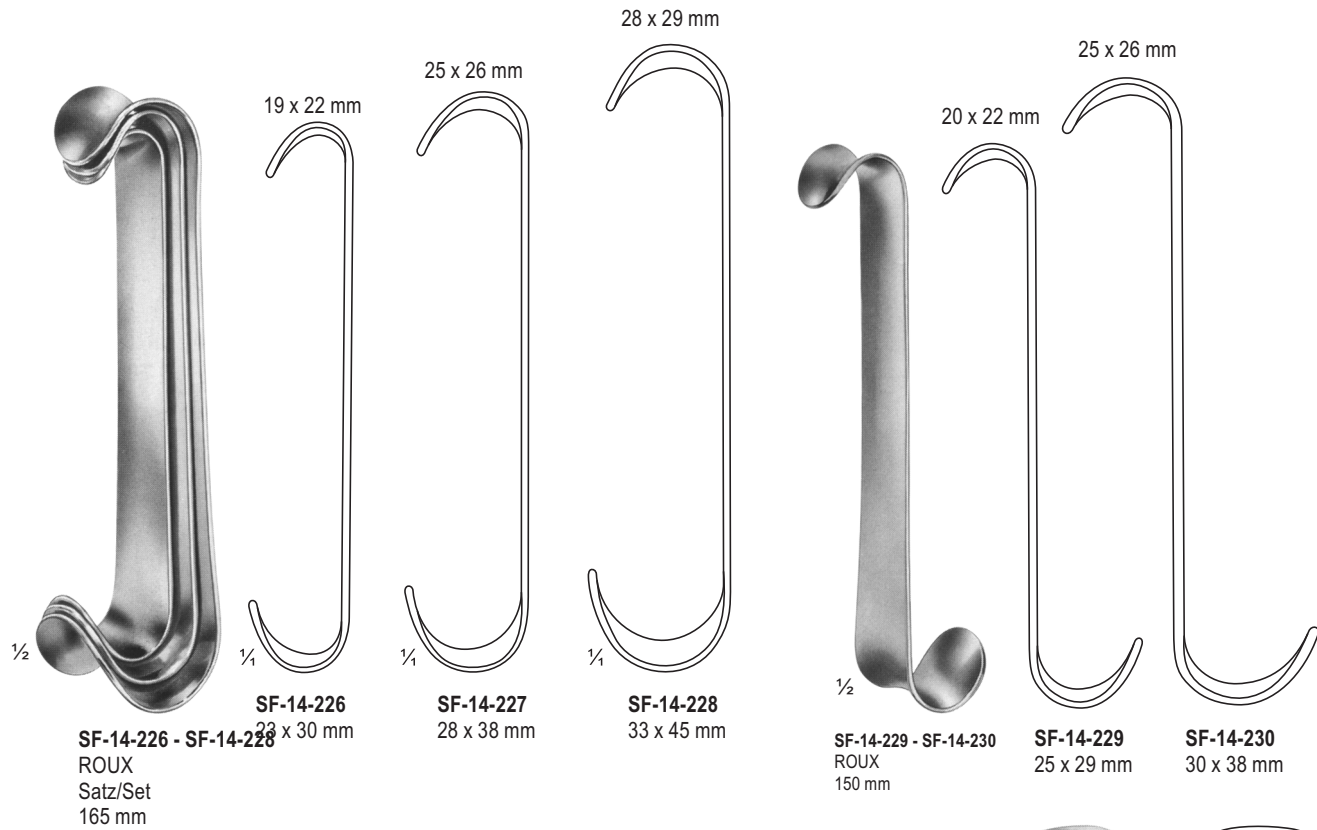



SF-14-234
KOCHER
Sharp
205 mm

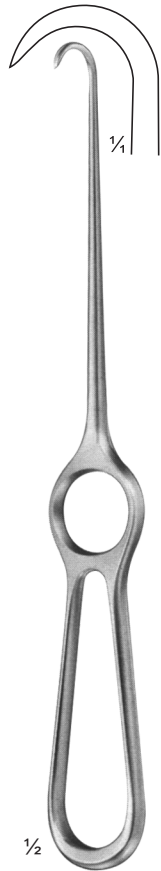

SF-14-235
KOCHER
Sharp
220 mm



SF-14-236
KOCHER
Blunt
220 mm

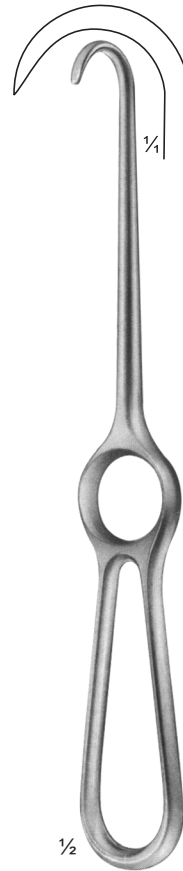

SF-14-237
VOLKMANN
Sharp
220 mm

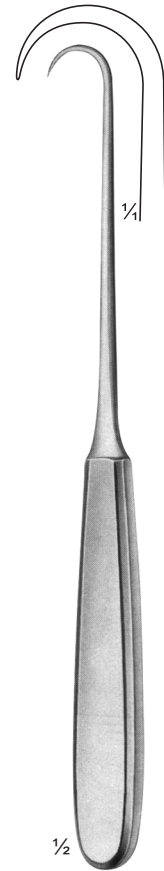

SF-14-238
VOLKMANN
Sharp
220 mm

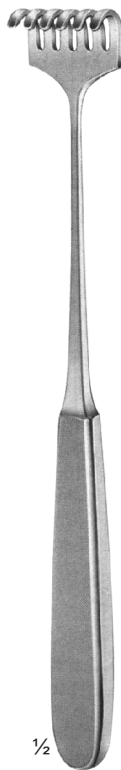

SF-14-239 - SF-14-246
VOLKMANN
225 mm

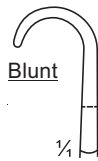
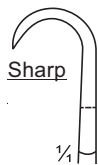

SF-14-239
9 x 8 mm



SF-14-240
9 x 13 mm



SF-14-241
9 x 19 mm

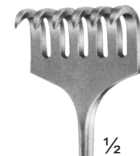

SF-14-242
9 x 29 mm



SF-14-243
8,5 x 8 mm



SF-14-244
8,5 x 13 mm



SF-14-245
8,5 x 19 mm

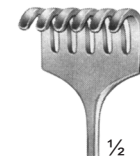

SF-14-246
8,5 x 29 mm

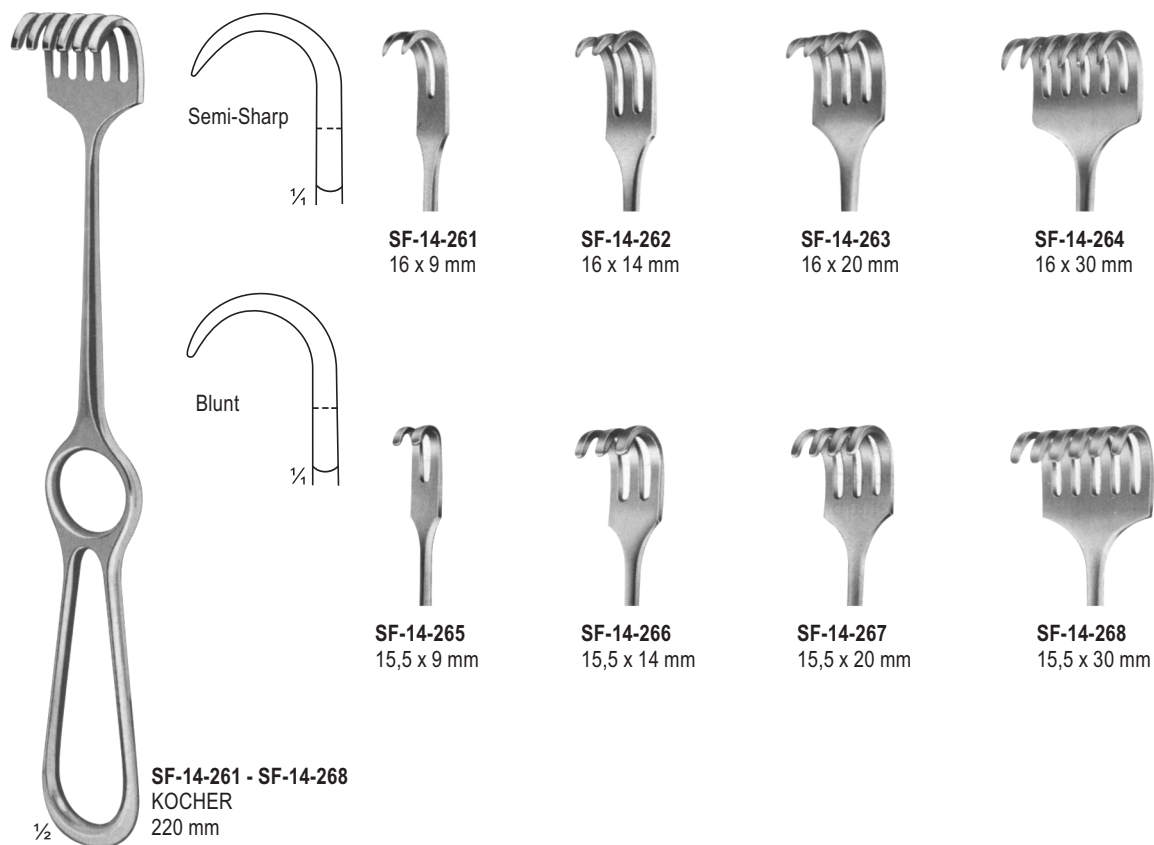
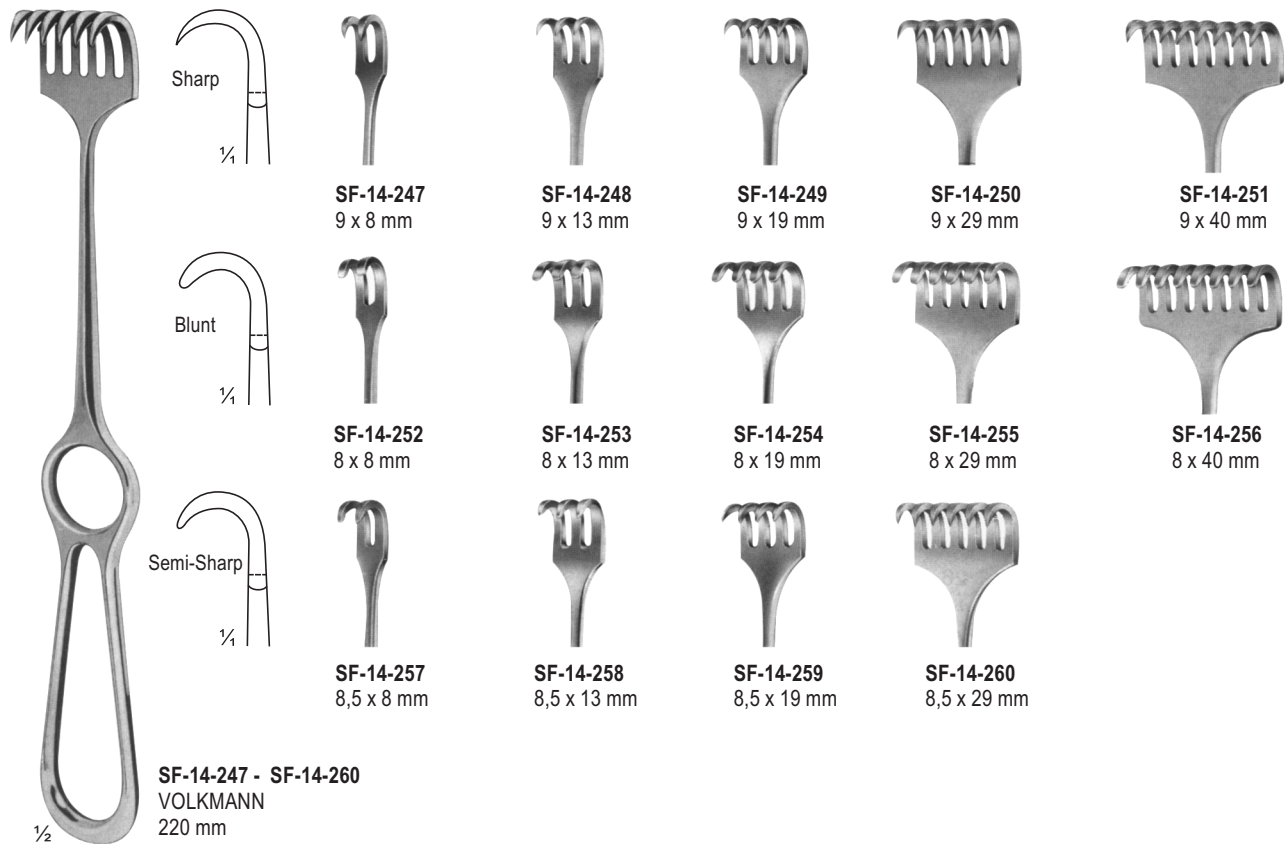



SF-14-268 - SF-14-270
KORTE
240 mm



SF-14-269
8 Prongs, blunt



SF-14-270
8 Prongs, sharp

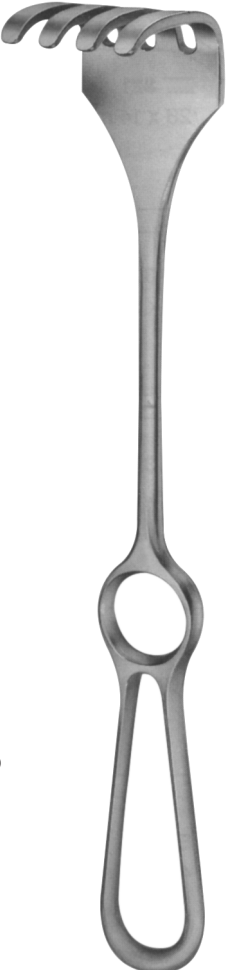

SF-14-271 - SF-14-274
ISRAEL
255 mm

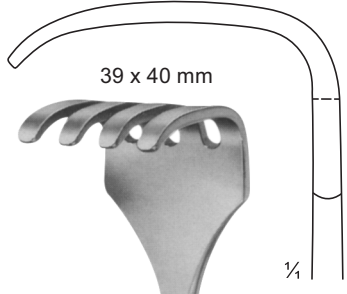

SF-14-271
4 Prongs, blunt

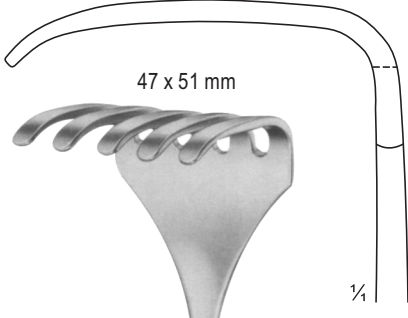

SF-14-272
5 Prongs, blunt

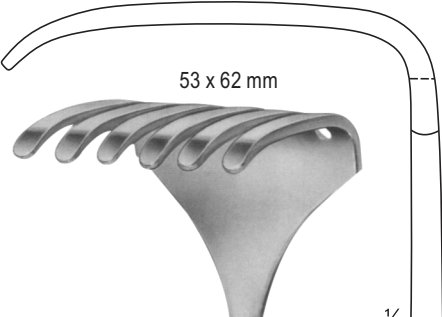

SF-14-273
6 Prongs, blunt

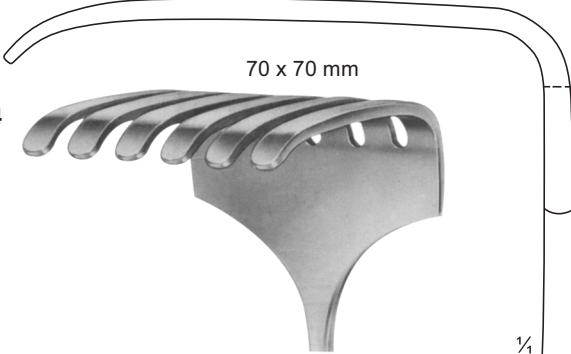

SF-14-274
6 Prongs, blunt

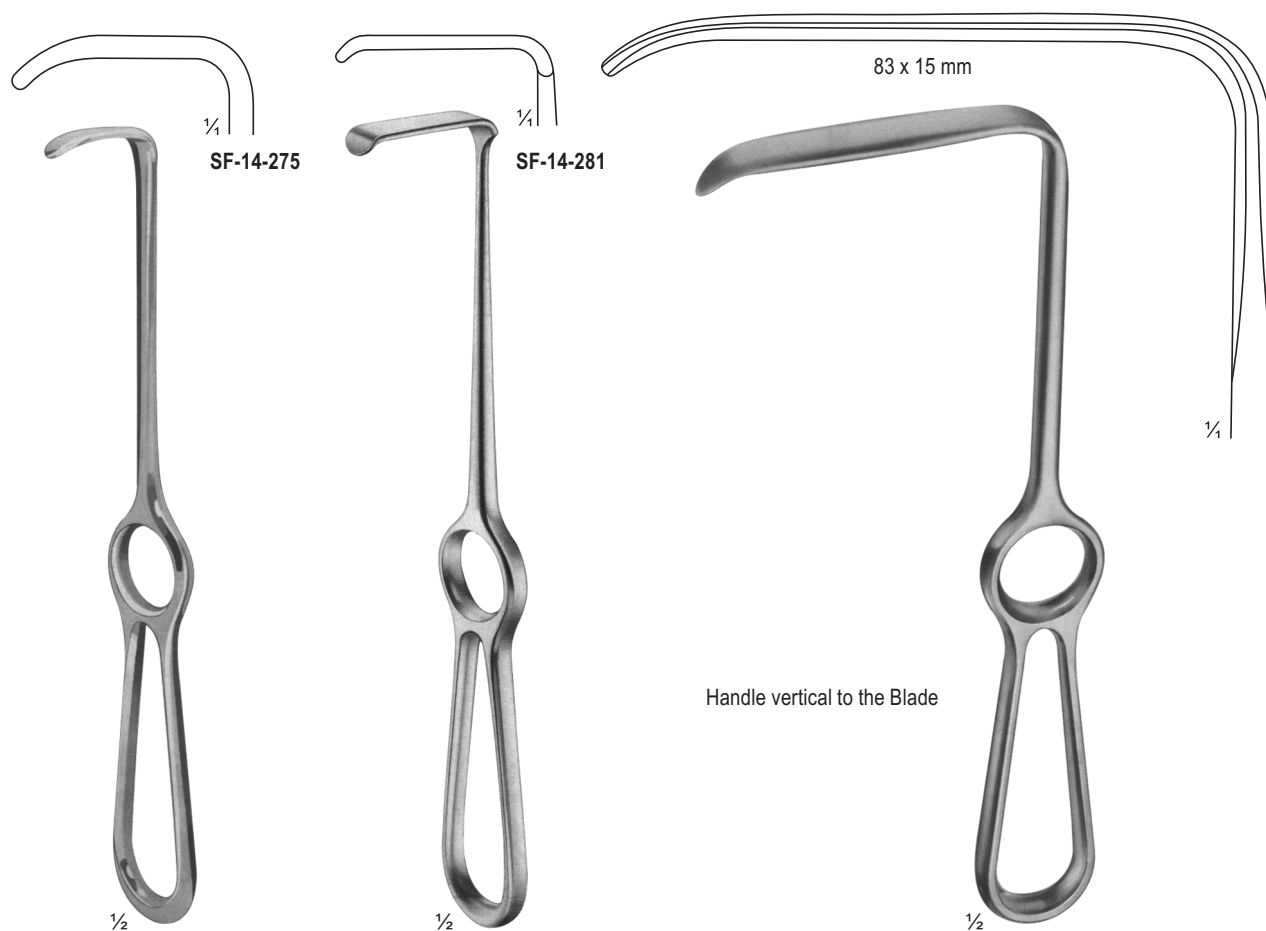

SF-14-275 - SF-14-280
LANGENBECK
210 mm

- SF-14-275 28 x 10 mm
- SF-14-276 28 x 14 mm
- SF-14-277 33 x 14 mm
- SF-14-278 28 x 16 mm
- SF-14-279 40 x 10 mm
- SF-14-280 40 x 13 mm

SF-14-281 - SF-14-287
KOCHER-LANGENBECK
215 mm

- SF-14-281 25 x 6 mm
- SF-14-282 35 x 8 mm
- SF-14-283 35 x 11 mm
- SF-14-284 35 x 15 mm
- SF-14-285 41 x 11 mm
- SF-14-286 55 x 11 mm
- SF-14-287 70 x 14 mm

SF-14-288
LANGENBECK
215 mm

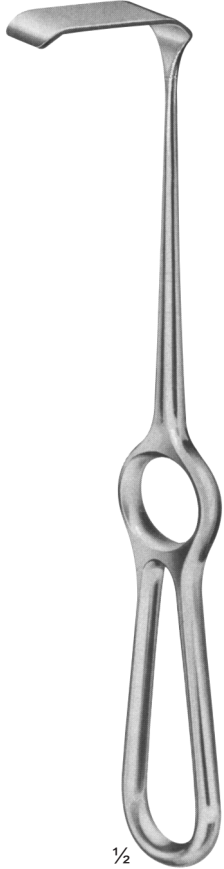

SF-14-289 - SF-14-293
KOCHER
230 mm

1/2

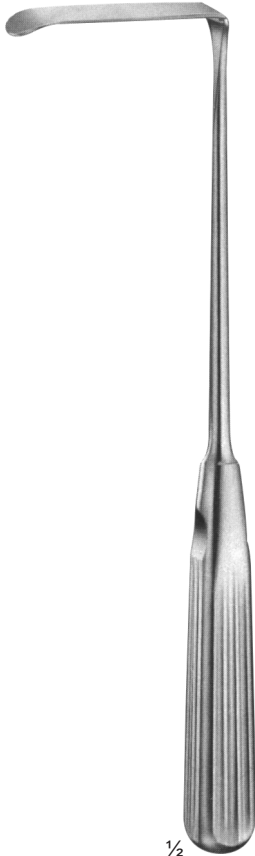

SF-14-294 - SF-14-296
SAUERBRUCH
225 mm

1/2

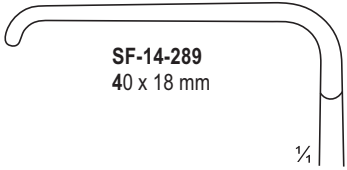

SF-14-289
40 x 18 mm

1/4

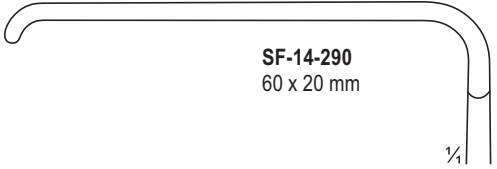

SF-14-290
60 x 20 mm

1/4

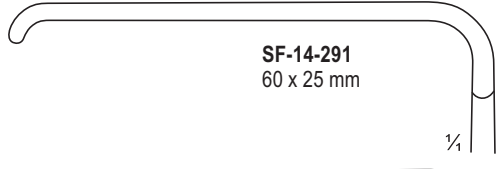

SF-14-291
60 x 25 mm

1/4

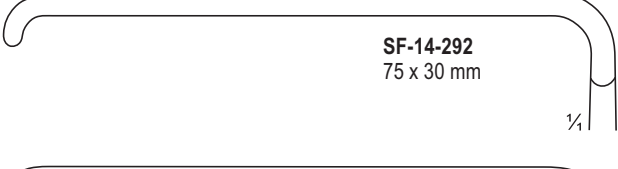

SF-14-292
75 x 30 mm

1/4

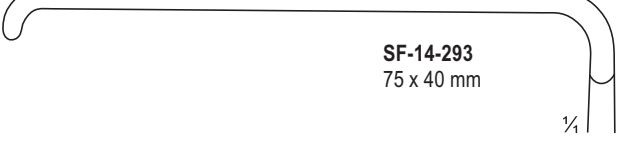

SF-14-293
75 x 40 mm

1/4

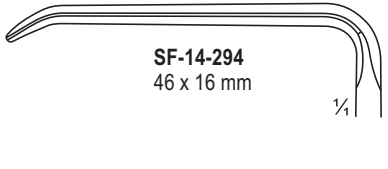

SF-14-294
46 x 16 mm

1/4

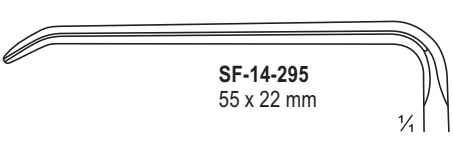

SF-14-295
55 x 22 mm

1/4

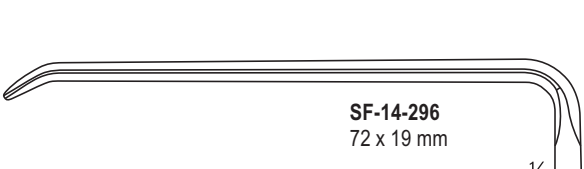

SF-14-296
72 x 19 mm

1/4

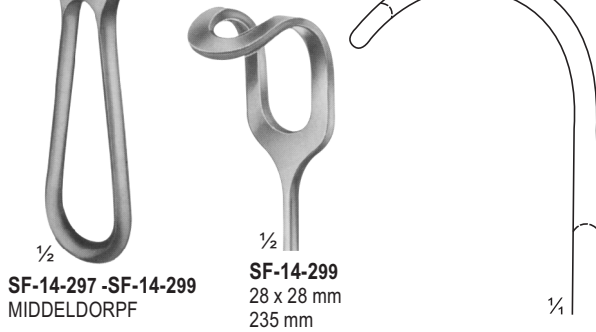
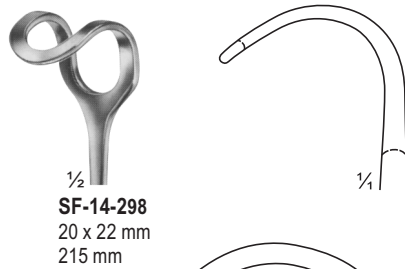

SF-14-297 - SF-14-299
MIDDELDORPF

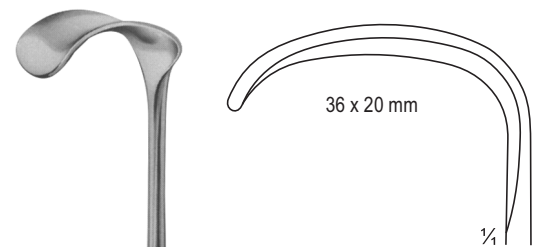
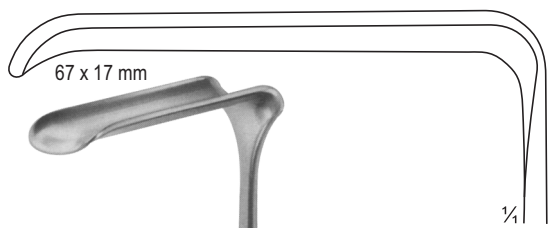
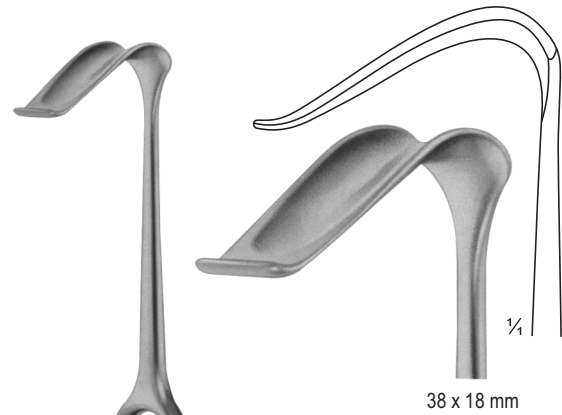



1/2

SF-14-303 - SF-14-308
HOSEL
250 mm

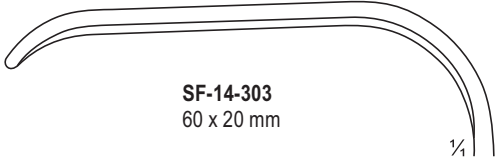

SF-14-303
60 x 20 mm

1/4

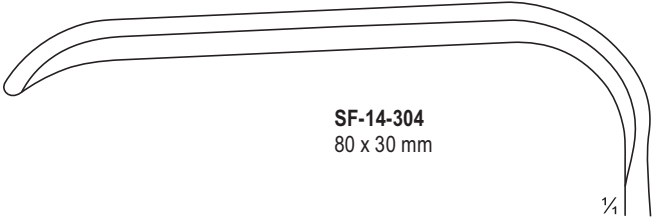

SF-14-304
80 x 30 mm

1/4

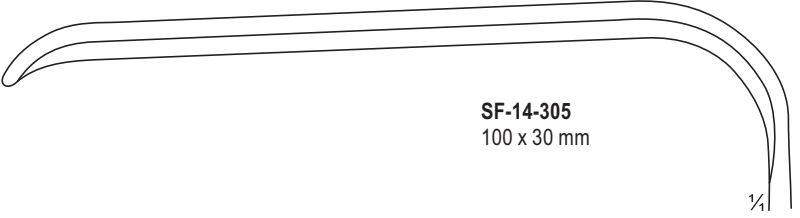

SF-14-305
100 x 30 mm

1/4

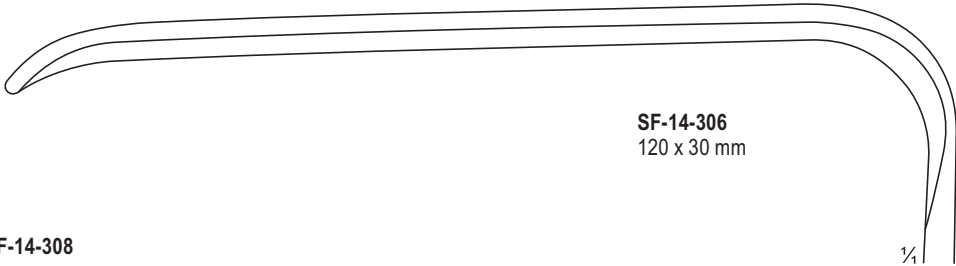

SF-14-306
120 x 30 mm

1/4

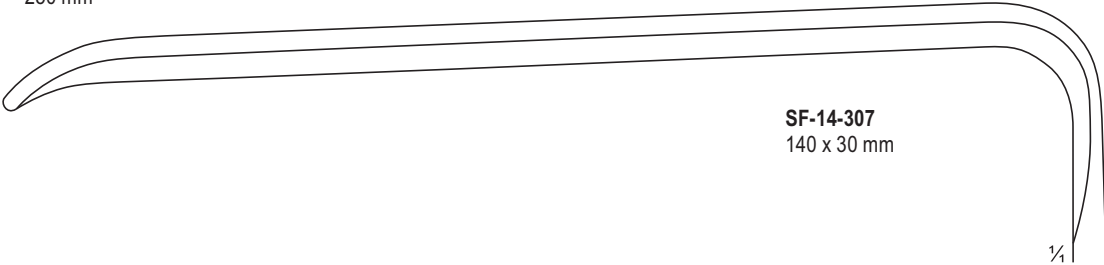

SF-14-307
140 x 30 mm

1/4

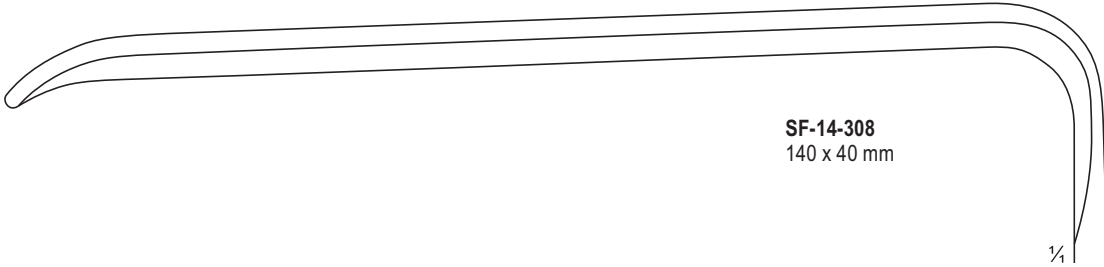

SF-14-308
140 x 40 mm

1/4

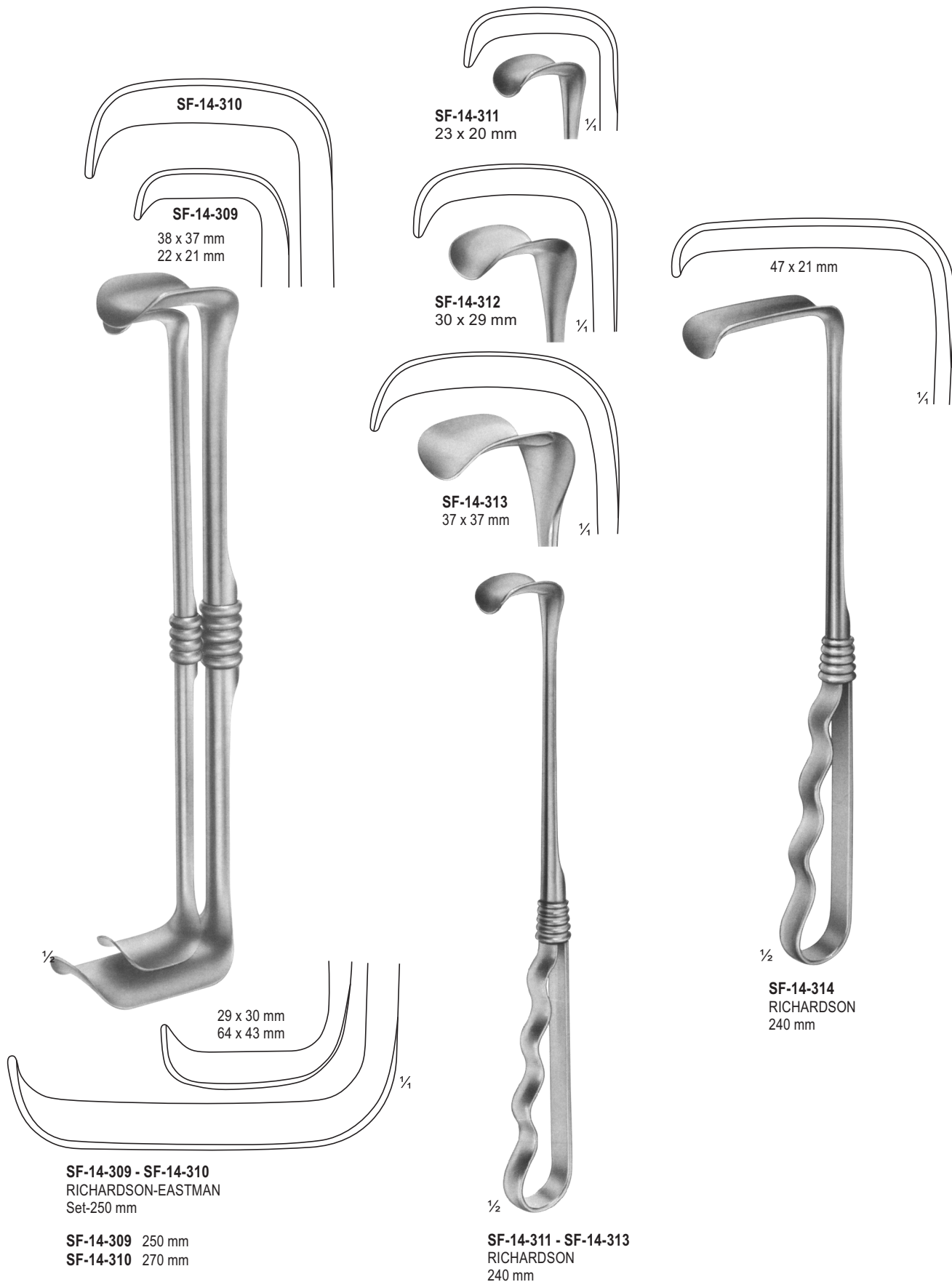

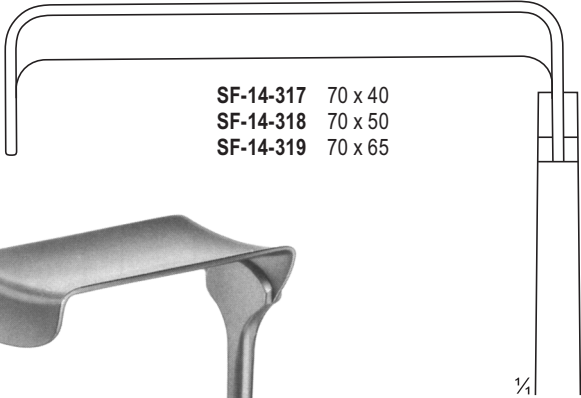
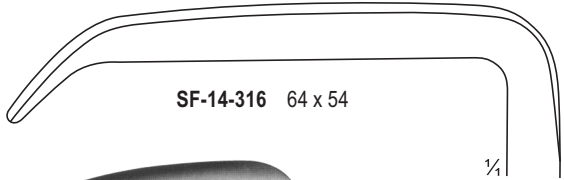
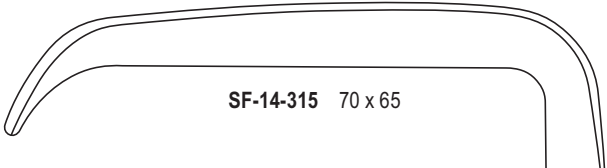

SF-14-315 - SF-14-316
KELLY
260 mm



SF-14-317 - SF-14-319
MORRIS
245 mm

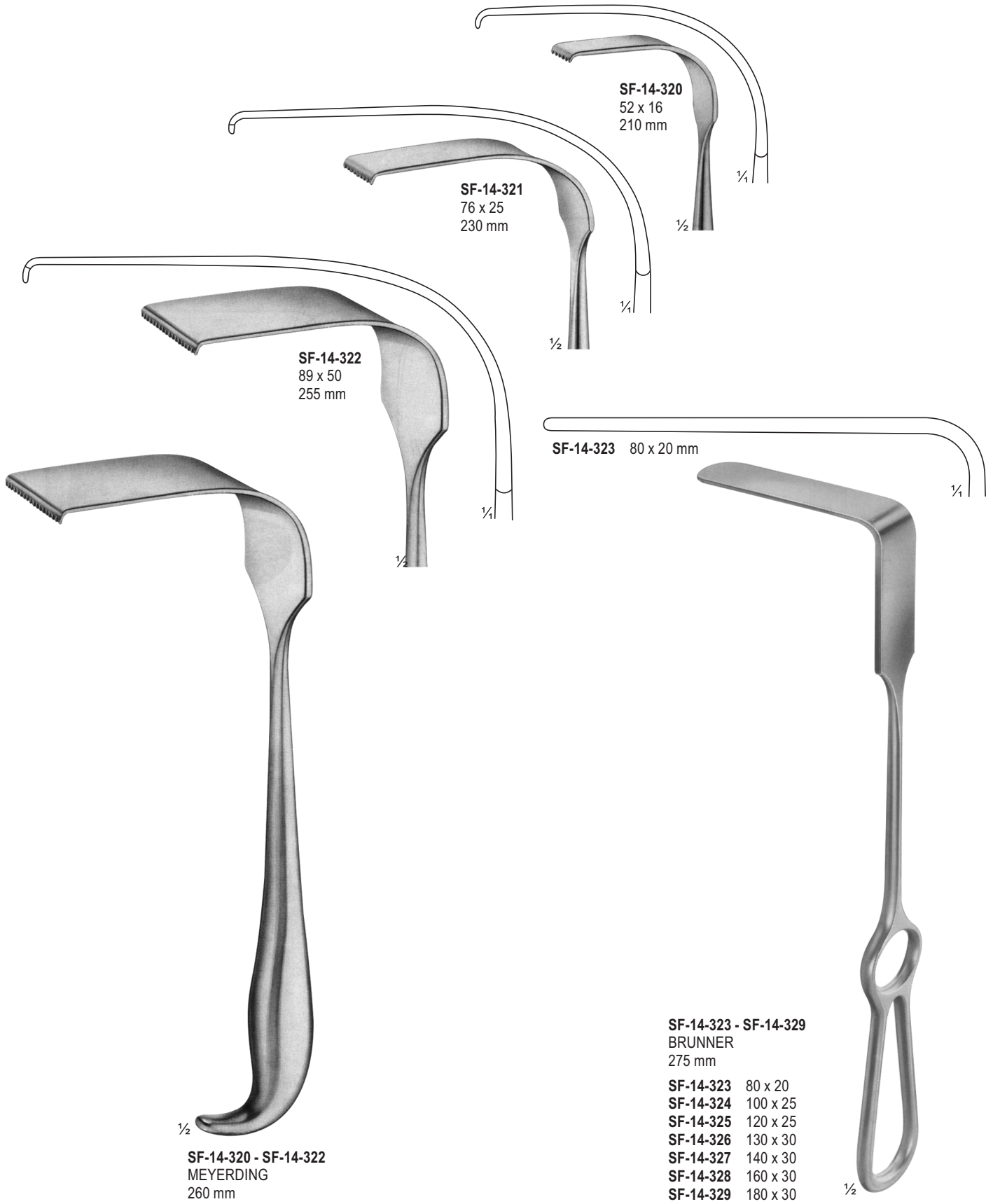

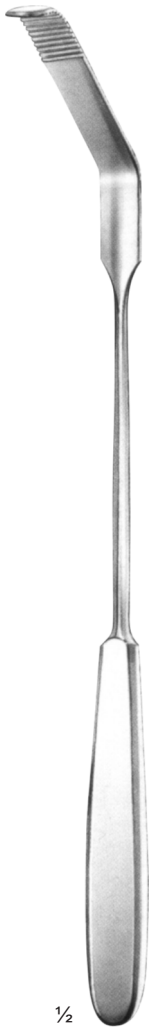

ZENKER
SF-14-330 - SF-14-335

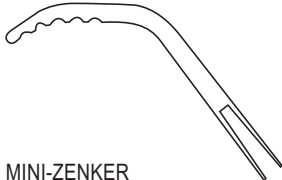

MINI-ZENKER
SF-14-330
180 mm
10 X 3 mm

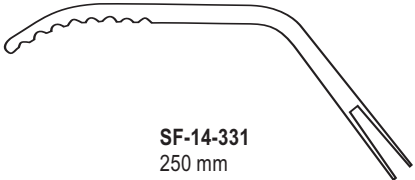

SF-14-331
250 mm
35 X 8 mm

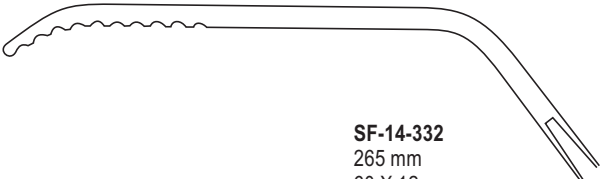

SF-14-332
265 mm
60 X 12 mm

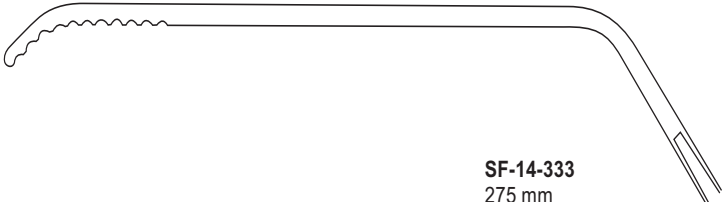

SF-14-333
275 mm
75 X 12 mm

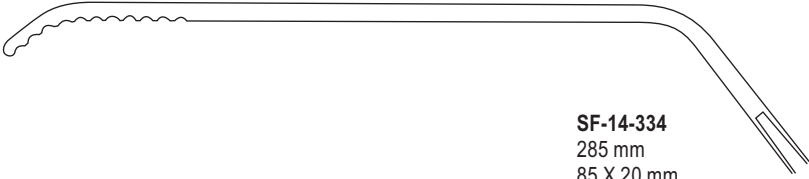

SF-14-334
285 mm
85 X 20 mm

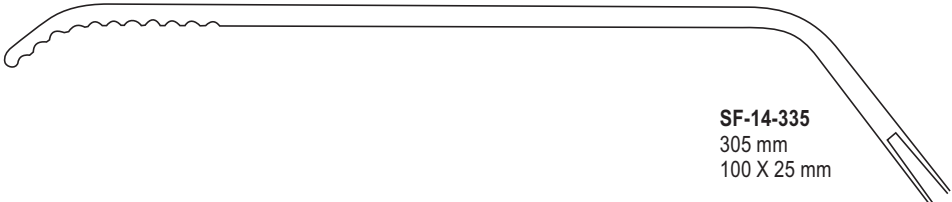

SF-14-335
305 mm
100 X 25 mm



HOSEL
SF-14-336 - SF-14-341
250 mm

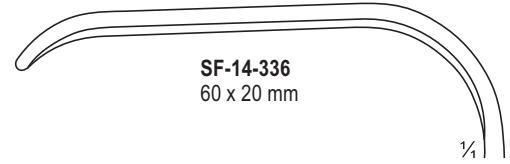

SF-14-336
60 x 20 mm

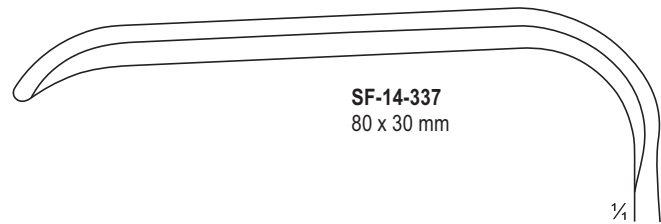

SF-14-337
80 x 30 mm

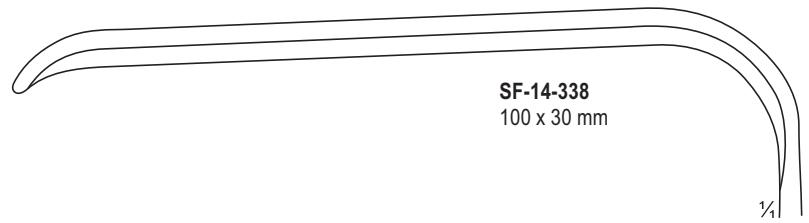

SF-14-338
100 x 30 mm

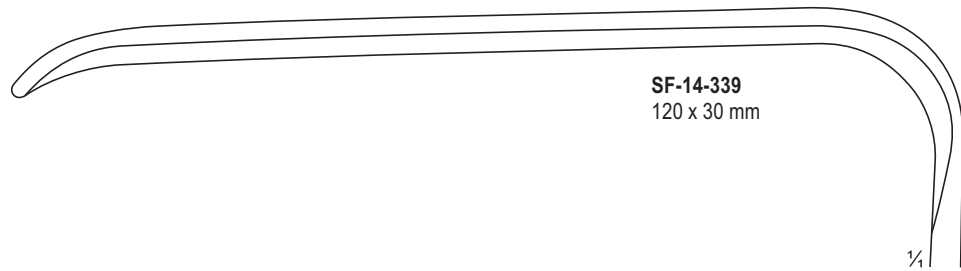

SF-14-339
120 x 30 mm

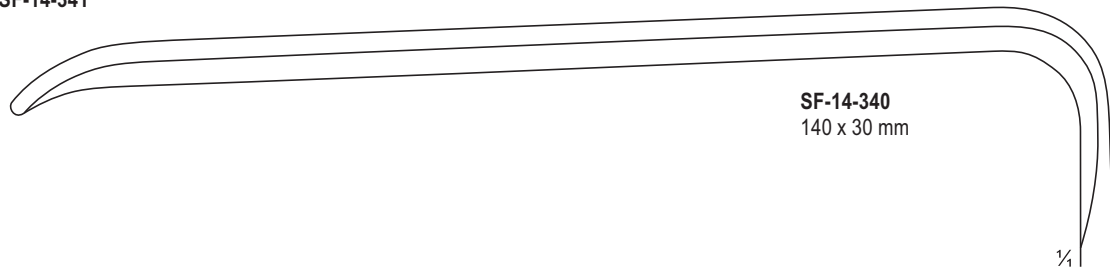

SF-14-340
140 x 30 mm

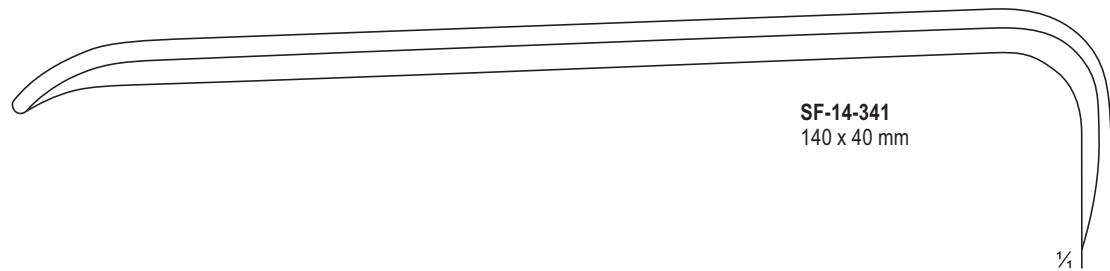

SF-14-341
140 x 40 mm



HÖSEL
SF-14-342 - SF-14-347
260 mm

1/2

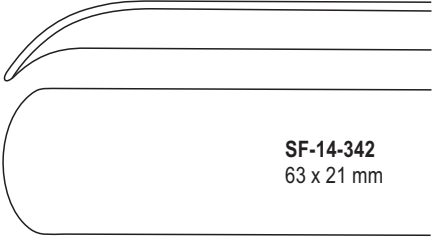

SF-14-342
63 x 21 mm

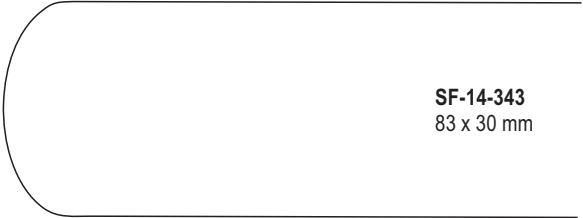

SF-14-343
83 x 30 mm

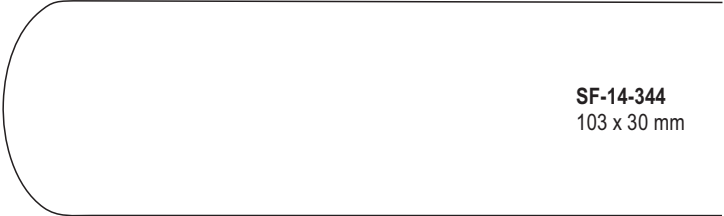

SF-14-344
103 x 30 mm

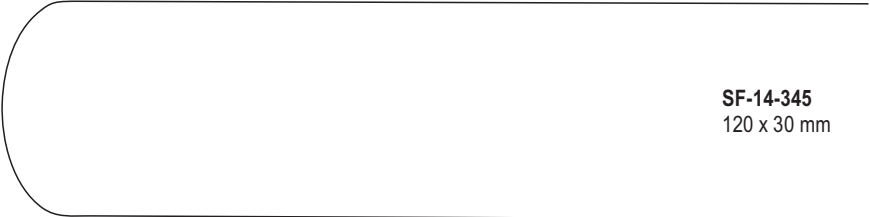

SF-14-345
120 x 30 mm

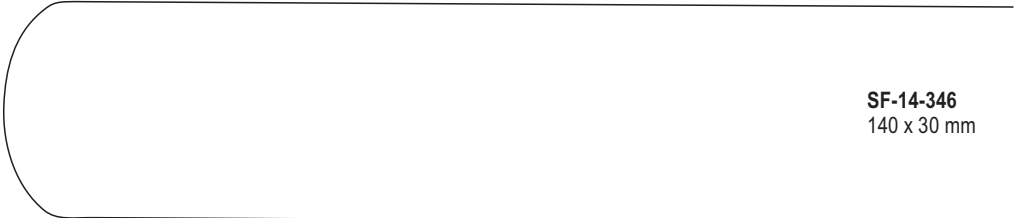

SF-14-346
140 x 30 mm

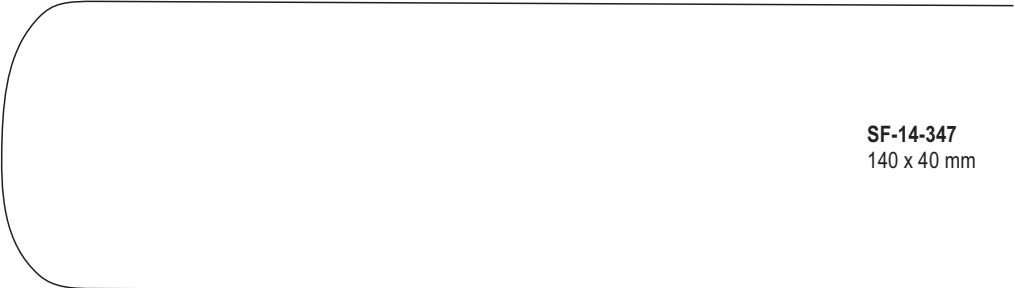

SF-14-347
140 x 40 mm

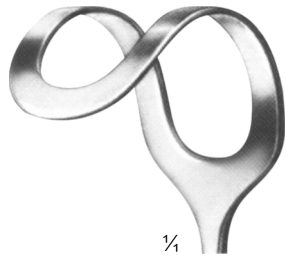

1/4

SF-14-348
270 mm
43 X 45 mm

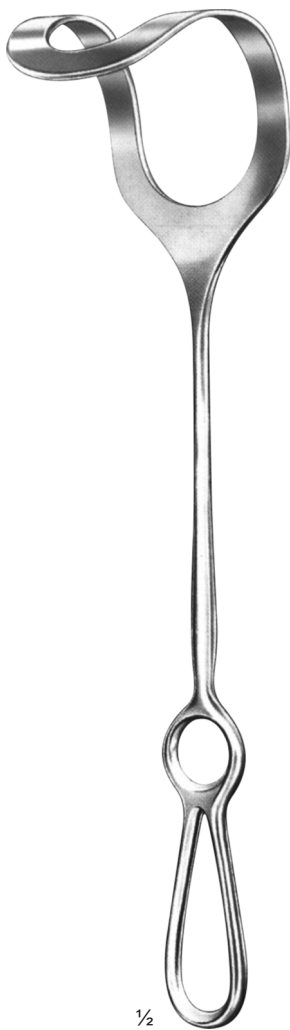
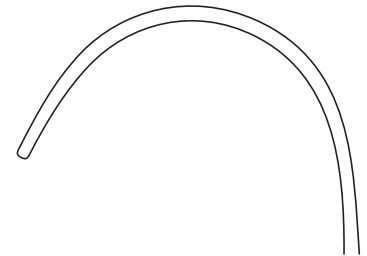

1/2

MIDDELDORPF
SF-14-348 - SF-14-350



SF-14-349
270 mm
52 X 50 mm

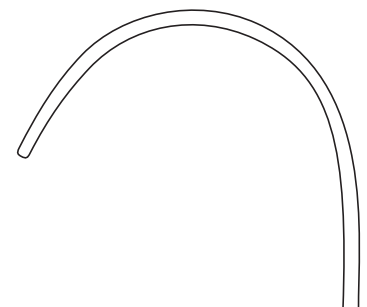

SF-14-350
280 mm
52 X 70 mm

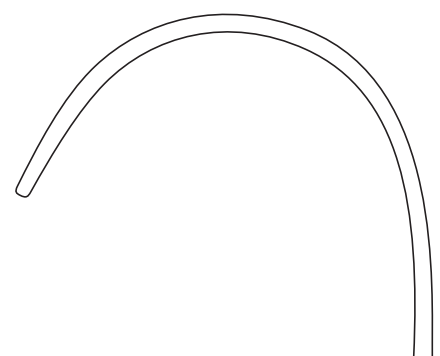

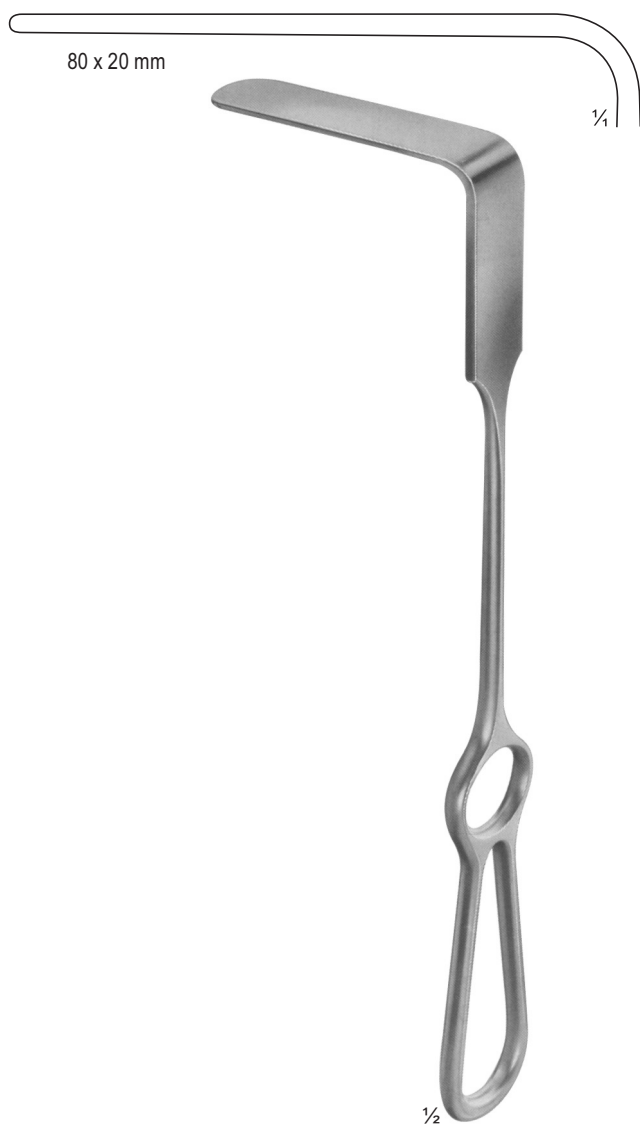

BRUNNER
SF-14-351 - SF-14-357
275 mm

- SF-14-351** 80 x 20
- SF-14-352** 100 x 25
- SF-14-353** 120 x 25
- SF-14-354** 130 x 30
- SF-14-355** 140 x 30
- SF-14-356** 160 x 30
- SF-14-357** 180 x 30

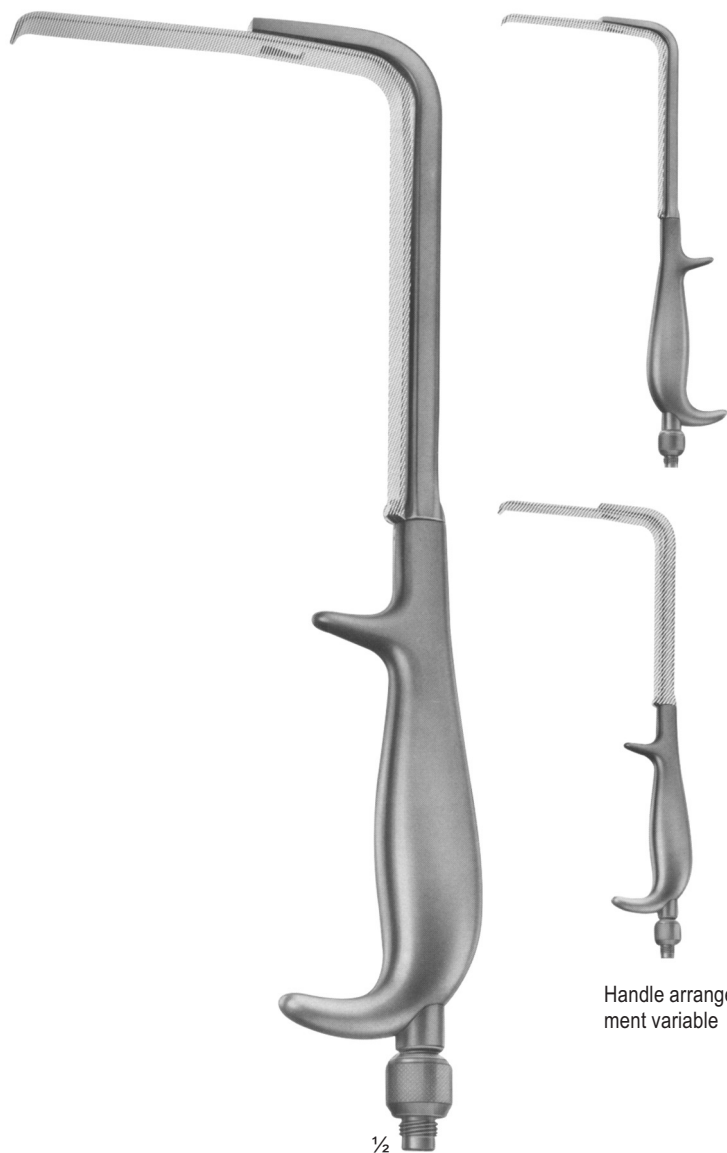

SF-14-358
Handle with cold
light carrier for
retractor blades.
280 mm

Handle arrange-
ment variable

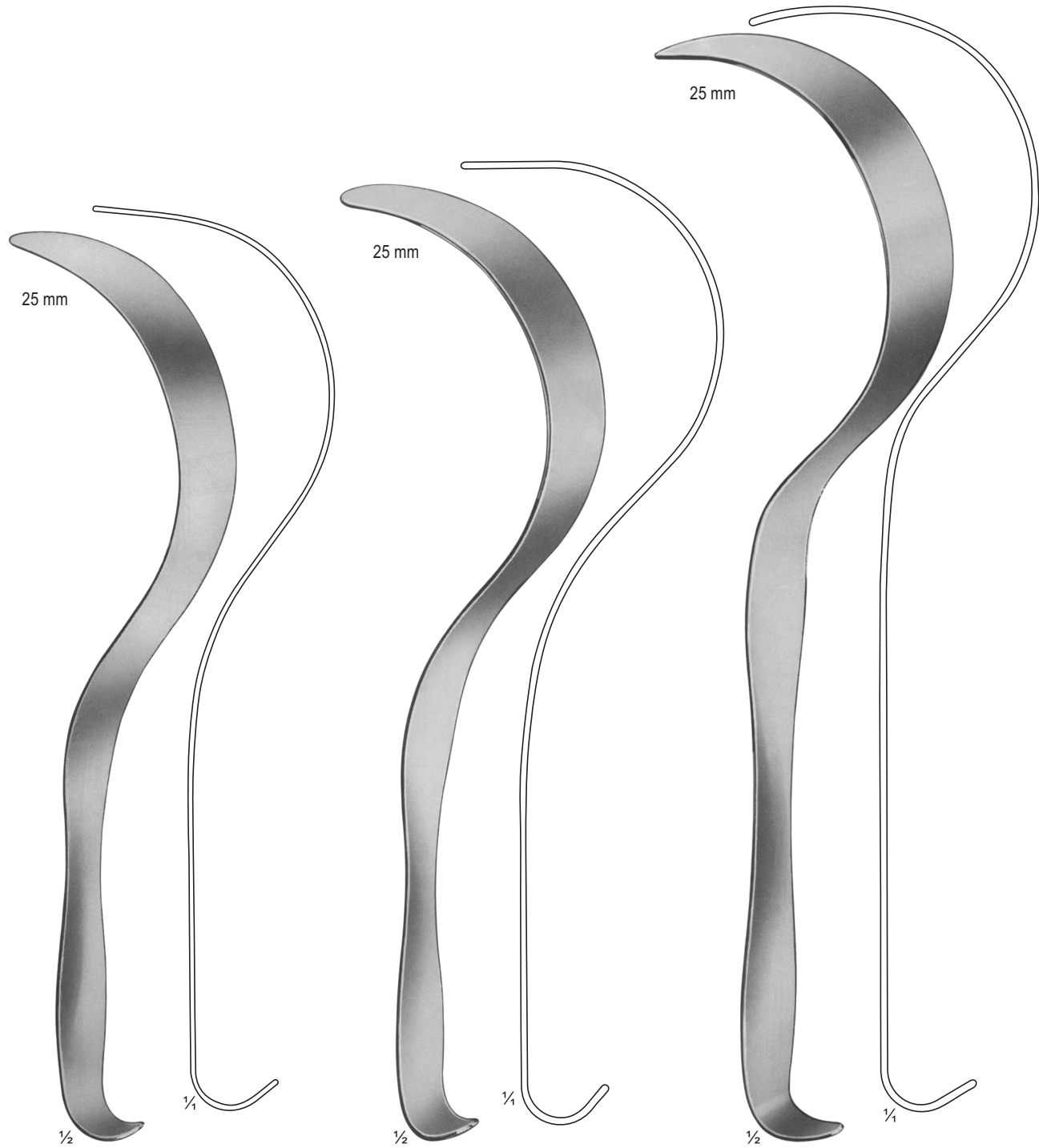

SF-14-359
DEAVER
300 mm
Fig. 1

SF-14-360
DEAVER
315 mm
Fig. 2

SF-14-361
DEAVER
365 mm
Fig. 2



Fig. 3
DEAVER
SF-14-362
300 mm

Fig. 4
DEAVER
SF-14-363
310 mm

Fig. 5
DEAVER
SF-14-364
320 mm

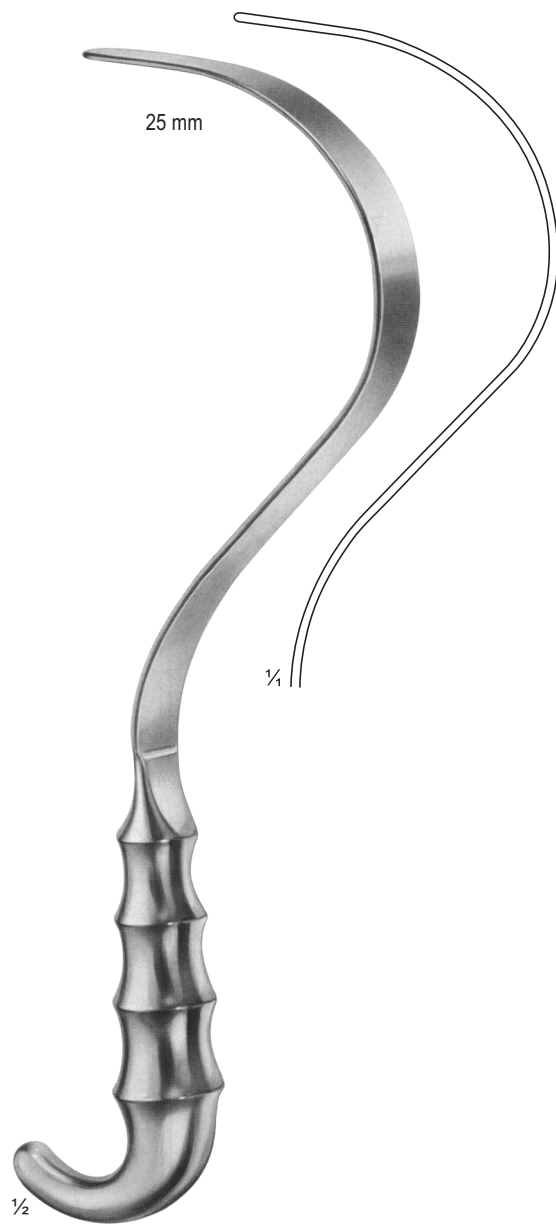

SF-14-365
DEAVER
310 mm
Fig. 1

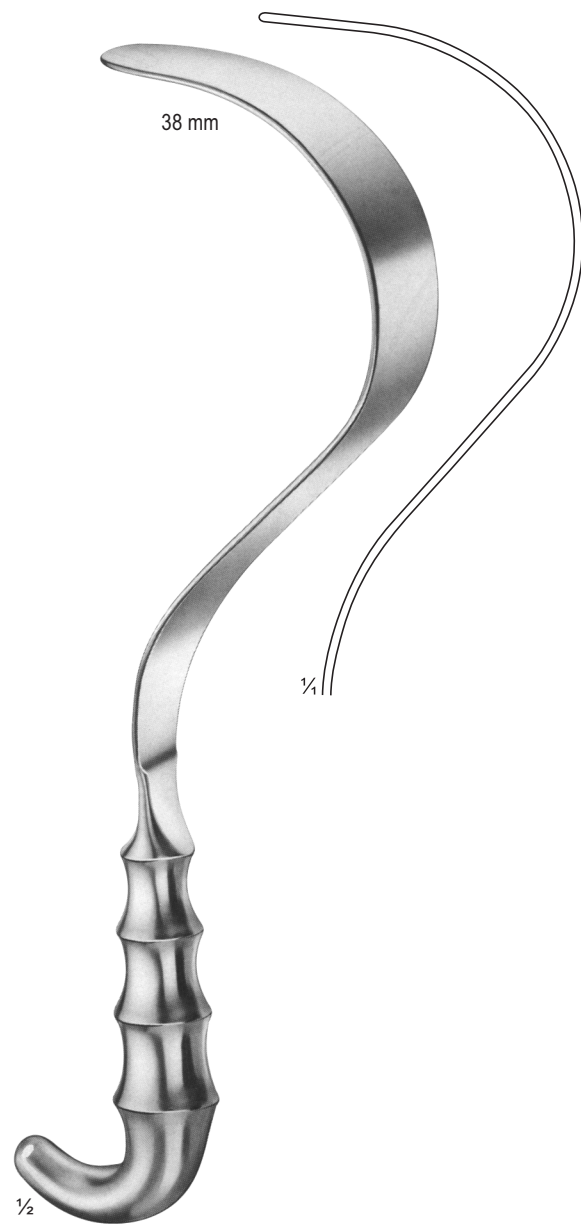

SF-14-366
DEAVER
310 mm
Fig. 3



COOLEY
SF-14-367
250 mm
Right
48 X 48 mm



COOLEY
SF-14-368
250 mm
Right, Serrated
48 X 48 mm

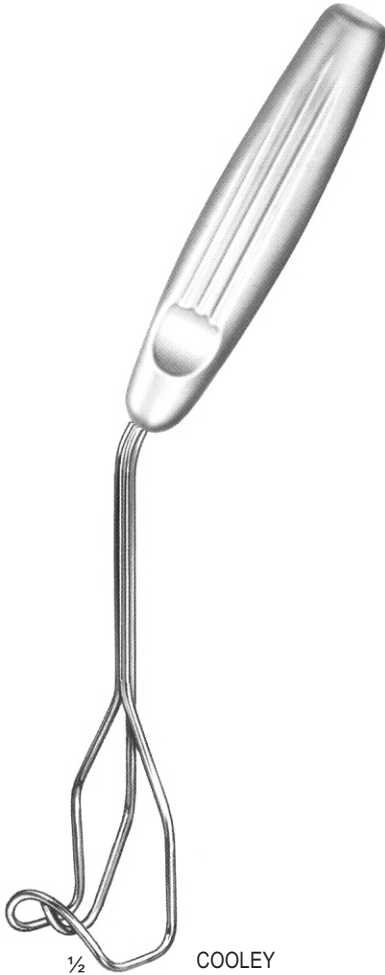

COOLEY
SF-14-369
275 mm
Left
30 X 48 mm

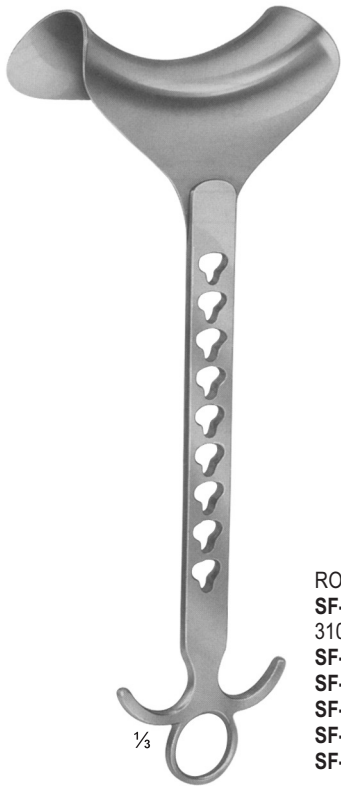

ROCHARD
SF-14-370 - SF-14-374
 310 mm
SF-14-370 48 x 90 mm
SF-14-371 48 x 105 mm
SF-14-372 48 x 120 mm
SF-14-373 48 x 135 mm
SF-14-374 48 x 155 mm



SF-14-375



DOYEN
SF-14-376 - SF-14-379
 280 mm
SF-14-376 48 x 90 mm
SF-14-377 48 x 105 mm
SF-14-378 48 x 120 mm
SF-14-379 48 x 135 mm



DOYEN-CHILD
SF-14-380
 Fixation device
 220 mm



SF-14-381
 Chain with
 weight (747 / 645g)
 790 mm



SENN-GREEN
SF-14-382 - SF-14-383
160 mm



Fig. 1
SF-14-382
20 X 6 mm

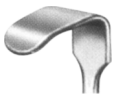

Fig. 2
SF-14-383
10 X 6 mm



RAGNELL-DAVIS
SF-14-384
150 mm



1/4
8 X 4.5 mm

15 X 5.5 mm



CUSHING
SF-14-385
205 mm

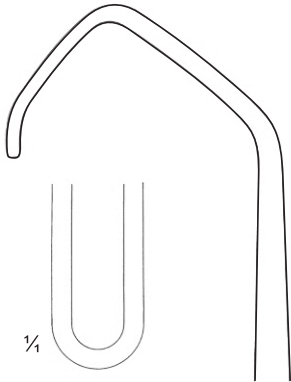

1/4

19 x 15 mm
19 x 15 mm



22 x 15 mm
22 x 15 mm

PARKER
SF-14-386
140 mm



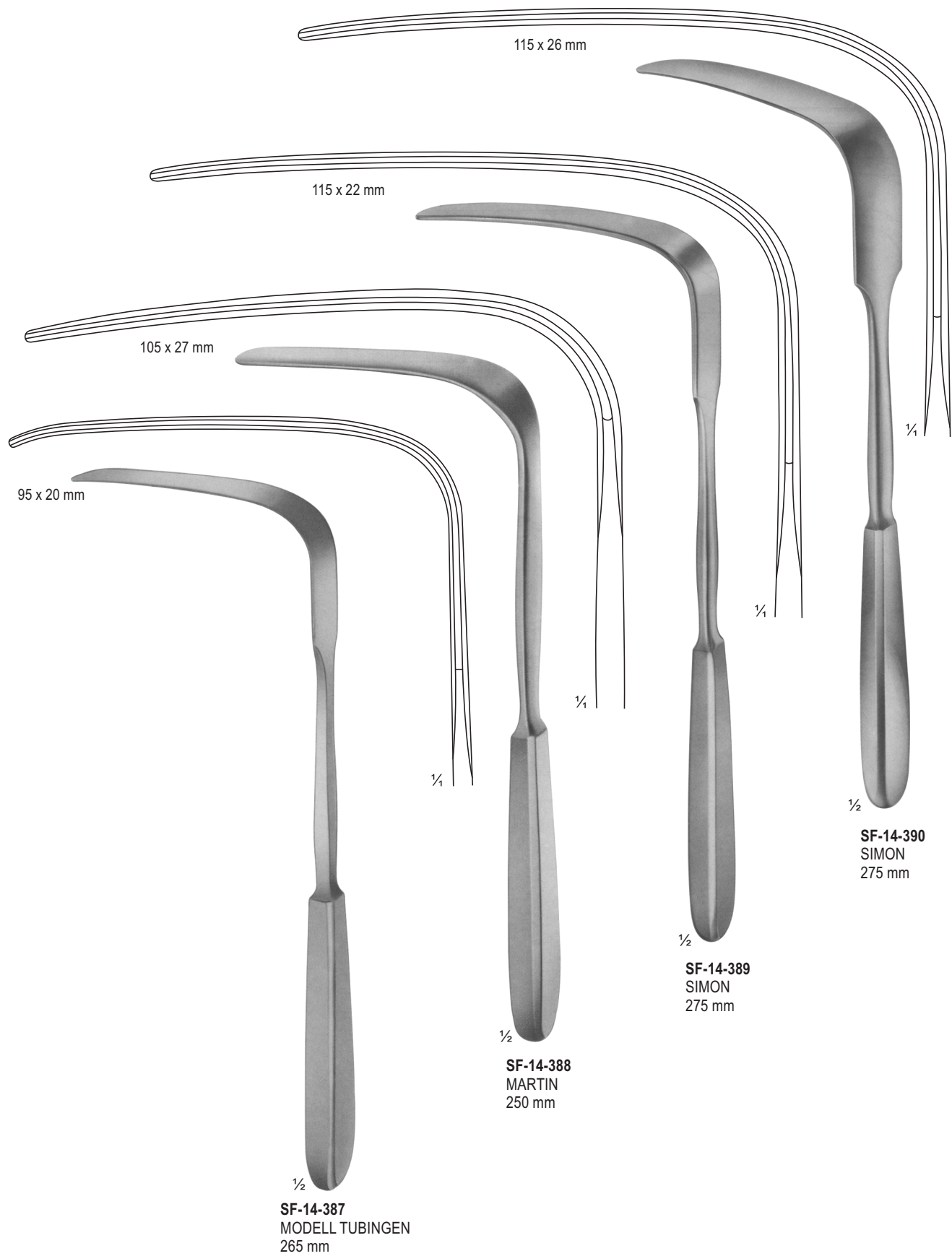

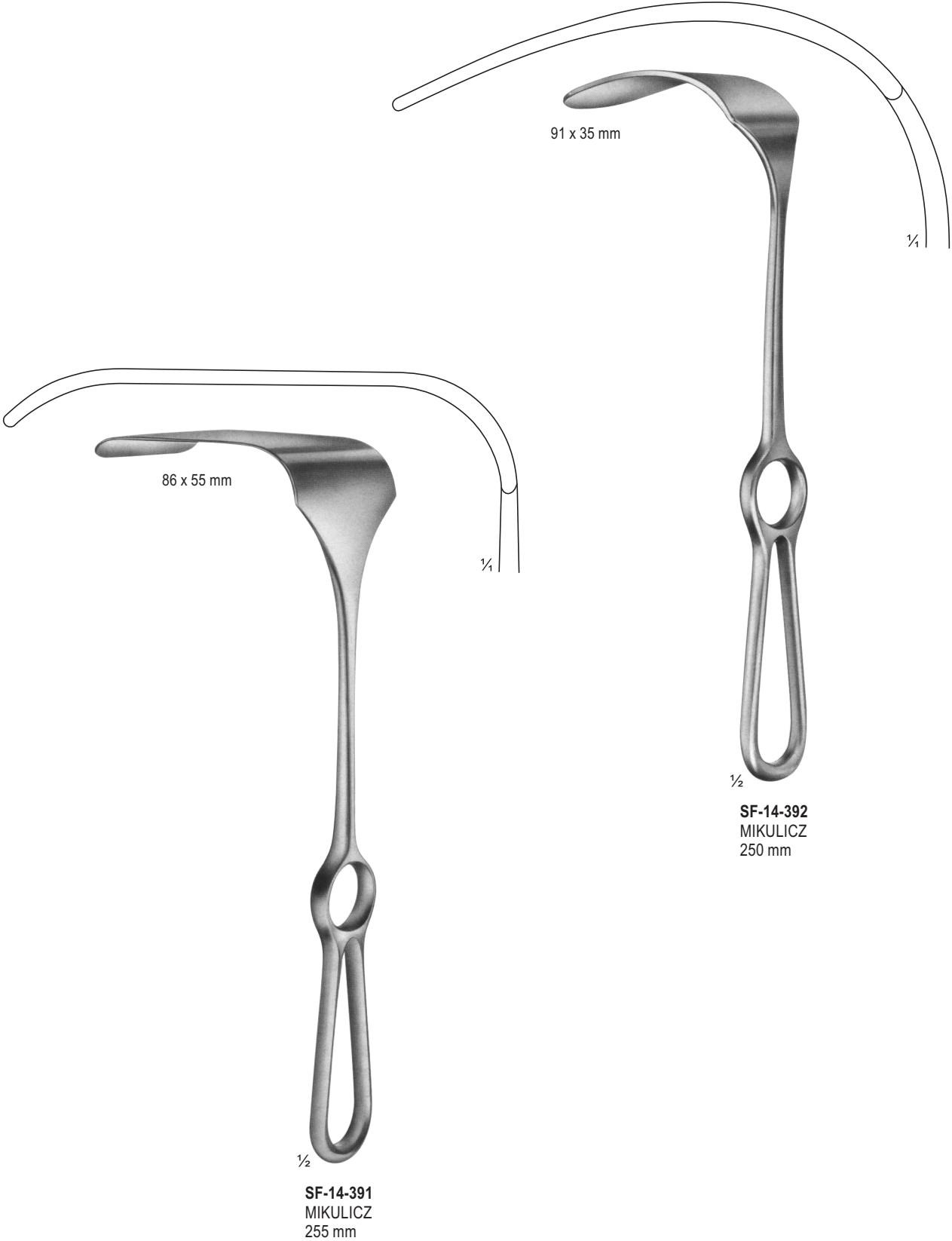

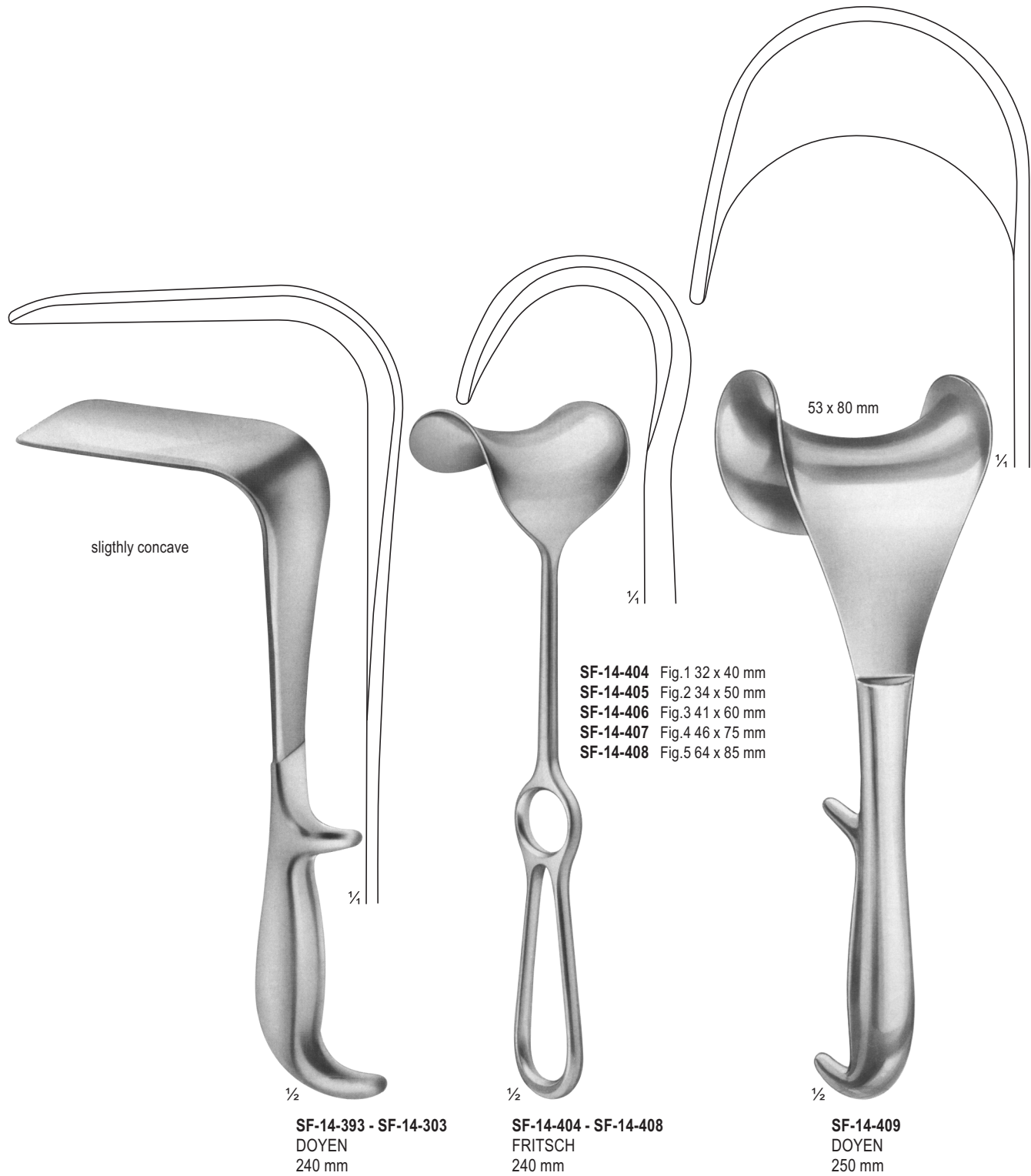

Width of Blades
35 mm, 45 mm, 60 mm

Length of Blades
62 mm
92 mm
122 mm
160 mm

SF-14-393 , SF-14-397 , SF-14-401
SF-14-394 , SF-14-398 , SF-14-402
SF-14-395 , SF-14-399 , SF-14-403
SF-14-396 , SF-14-400

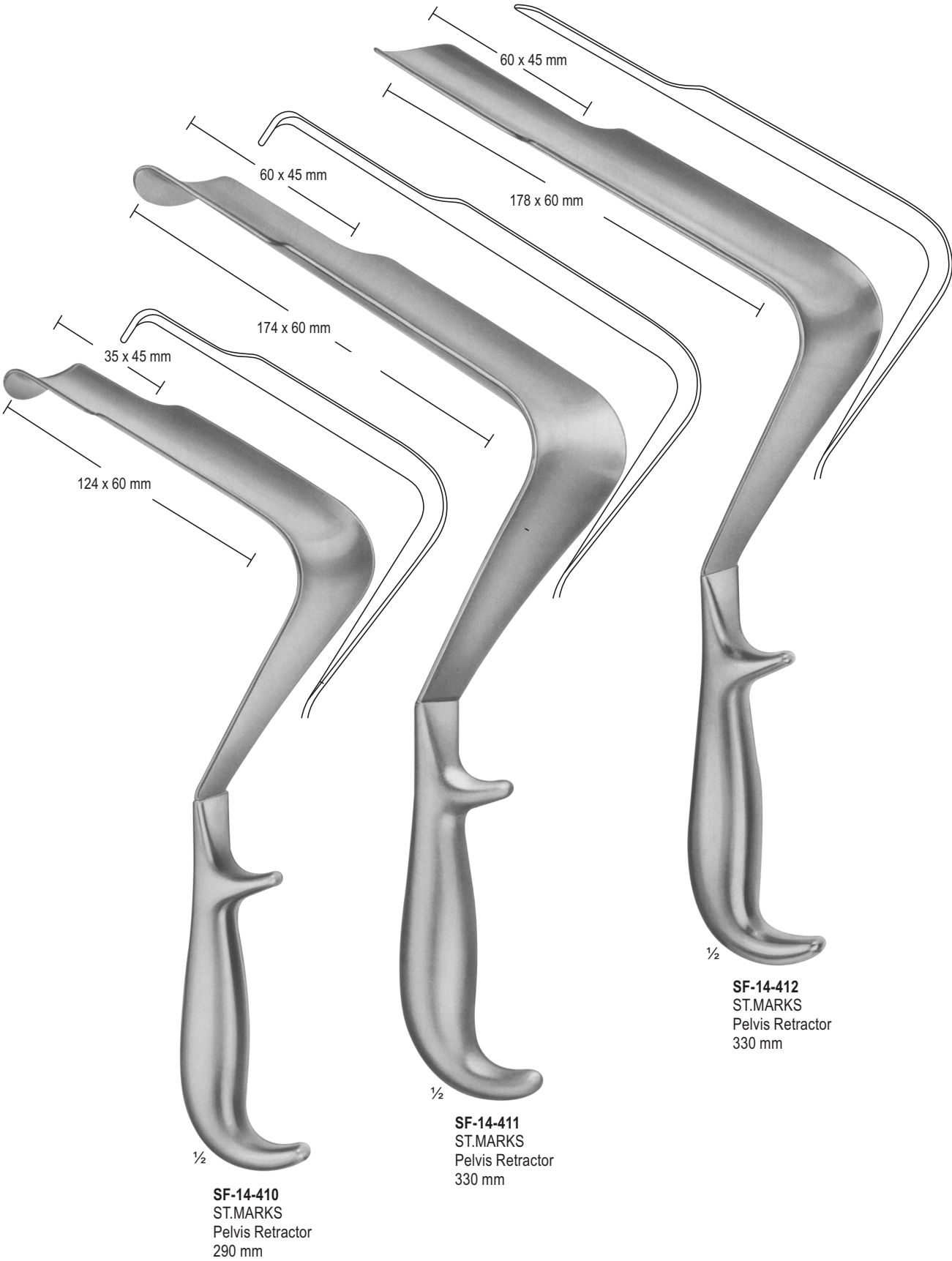

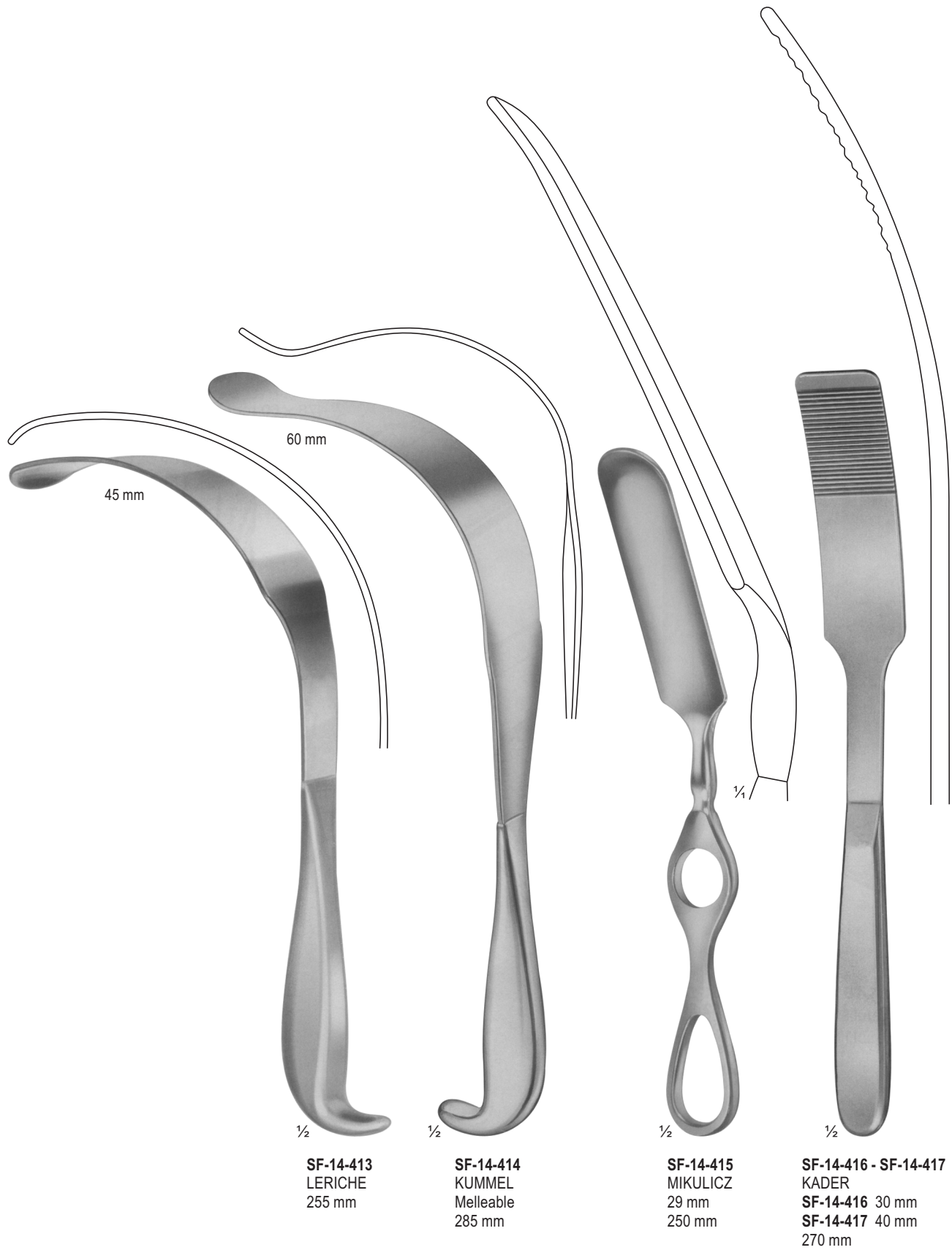

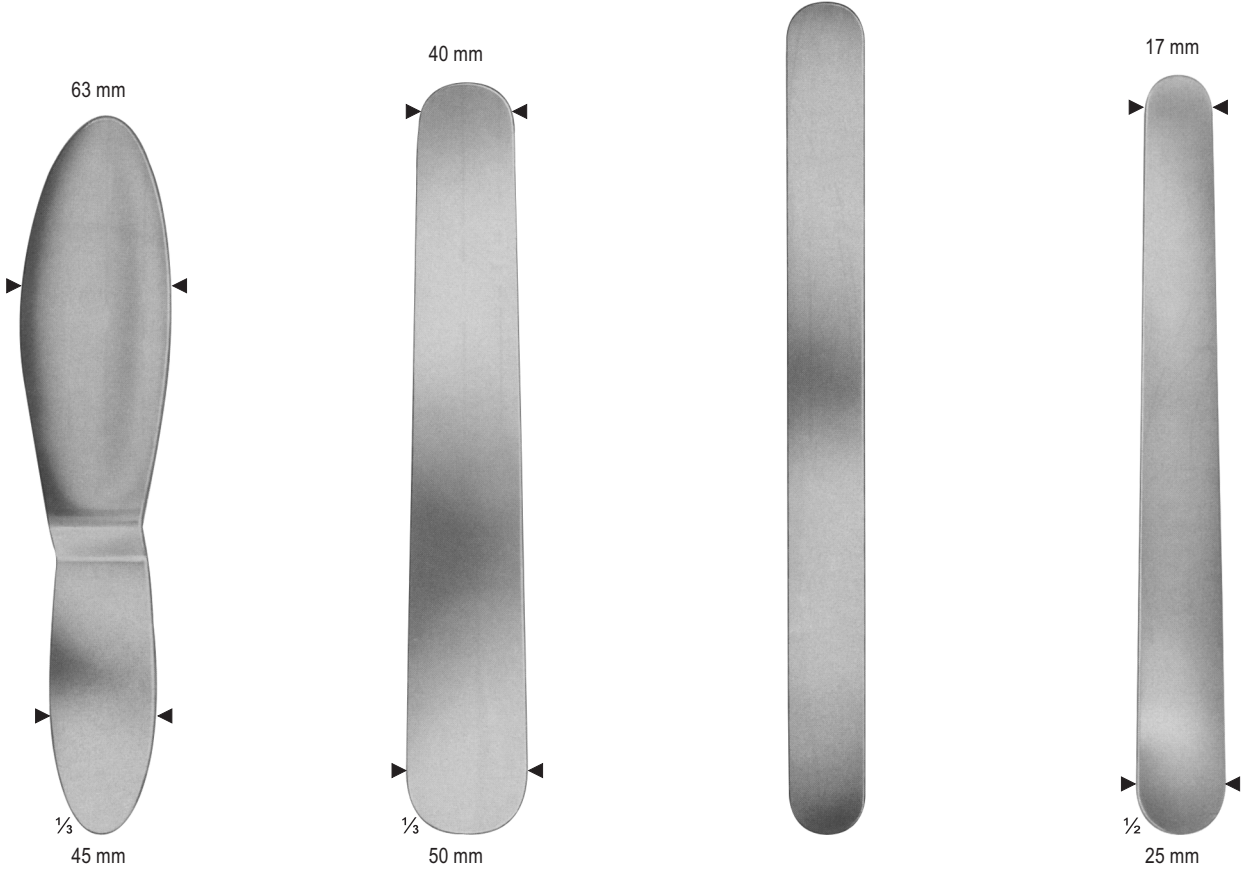

SF-14-418
REVERDIN
285 mm

SF-14-419
HABERER
Malleable
305 mm

SF-14-420 - SF-14-422
SF-14-420 30 mm
SF-14-421 40 mm
SF-14-422 50 mm
 Malleable
 330 mm

SF-14-423
TUFFIER
Melleable
200 mm



Surgiforce Instruments



Opposite Surgical Association,
Malkay Kalan, Marala Road,
Sialkot-51050 Pakistan.



+92 523 559131



info@surgiforce.com
sales@surgiforce.com



www.surgiforce.com



Our Certifications:

ISO 9001

CE Certified

EN 13485:2012

ISO 7153-1

ISO 7151

ISO 17664:2004

ISO 13402

ISO 15223



No.3012922148