

Page
186–222

▪ ENT Surgery

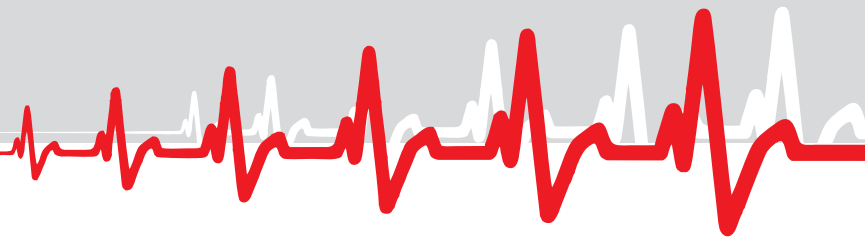



¼

ZÖLLNER
SF-10-101 - SF-10-106
set for adults, black



1:1

SF-10-101
Fig.1
5.5 X 6.5 mm Ø



1:1

SF-10-102
Fig.2
6.5 X 7.5 mm Ø



1:1

SF-10-103
Fig.3
7.5 X 8.5 mm Ø



1:1

SF-10-104
Fig.4
8.5 X 9.5 mm Ø

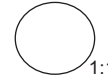

1:1

SF-10-105
Fig.5
9.5 X 10.5 mm Ø

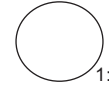

1:1

SF-10-106
Fig.6
10.5 X 11.5 mm Ø



¼

POLITZER
SF-10-107 - SF-10-110
set for adults

○ 1:1

SF-10-107
Fig.1
2 mm Ø

○ 1:1

SF-10-108
Fig.2
3 mm Ø

○ 1:1

SF-10-109
Fig.3
4 mm Ø

○ 1:1

SF-10-110
Fig.4
5 mm Ø



¼

BOUCHERON
SF-10-111 - SF-10-113
set for children

○ 1:1

SF-10-111
Fig.0
3.0 mm Ø

○ 1:1

SF-10-112
Fig.1
4.5 mm Ø

○ 1:1

SF-10-113
Fig.2
5.5 mm Ø



¼

HARTMANN
SF-10-114 - SF-10-117
set for adults

○ 1:1

SF-10-114
Fig.1
4.5 mm Ø

○ 1:1

SF-10-115
Fig.2
5.5 mm Ø

○ 1:1

SF-10-116
Fig.3
6.5 mm Ø

○ 1:1

SF-10-117
Fig.4
7.5 mm Ø

EAR CURETTES

www.surgiforce.com



BUCK
SF-10-118 - SF-10-133
Blunt
Sharp
165 mm - 6½"



SF-10-118
Fig.000



SF-10-119
Fig.00



SF-10-120
Fig.0



SF-10-121
Fig.1



SF-10-122
Fig.2



SF-10-123
Fig.3



SF-10-124
Fig.4



SF-10-125
Fig.5



SF-10-126
Fig.000



SF-10-127
Fig.00



SF-10-128
Fig.0



SF-10-129
Fig.1



SF-10-130
Fig.2



SF-10-131
Fig.3



SF-10-132
Fig.4



SF-10-133
Fig.5



BUCK
SF-10-134 - SF-10-149
Curved, blunt
Curved, sharp
165 mm - 6½"



SF-10-134
Fig.000



SF-10-135
Fig.00



SF-10-136
Fig.0



SF-10-137
Fig.1



SF-10-138
Fig.2



SF-10-139
Fig.3



SF-10-140
Fig.4



SF-10-141
Fig.5



SF-10-142
Fig.000



SF-10-143
Fig.00



SF-10-144
Fig.0



SF-10-145
Fig.1



SF-10-146
Fig.2



SF-10-147
Fig.3



SF-10-148
Fig.4



SF-10-149
Fig.5

Picture Show The Outer Diameter



LANGENBECK
SF-10-150
Blunt
130 mm - 5"



JANSEN
SF-10-151
Sharp
170 mm - 6 3/4"



GROSS
SF-10-152
Sharp, not fenestrated
120 mm - 4 3/4"

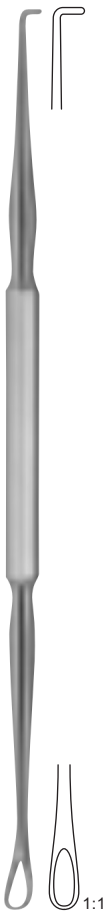

SF-10-153
Blunt, fenestrated
120 mm - 4 3/4"

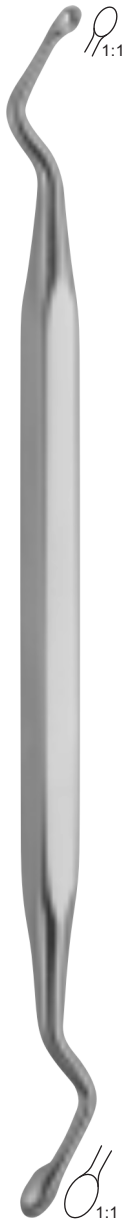

JANSEN
SF-10-154
Sharp
160 mm - 6 1/4"



BILLEAU
SF-10-155 - SF-10-157
165 mm - 6½"

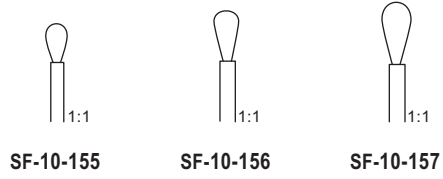

LUCAE
SF-10-158 - SF-10-160
140 mm - 5½"

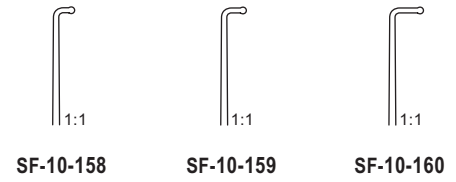

WAGENER
SF-10-161 - SF-10-167
140 mm - 5½"

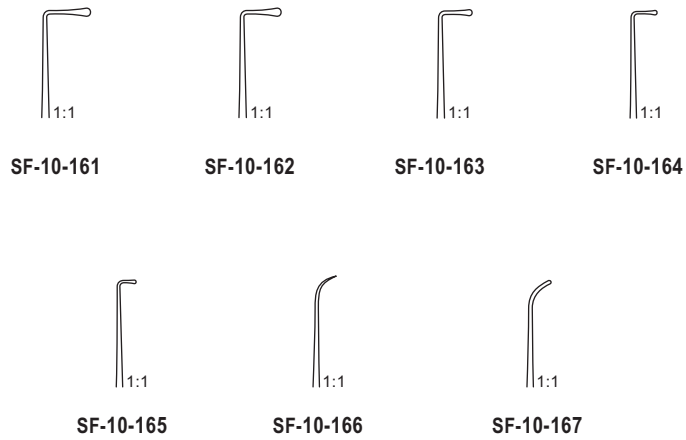



POLITZER
SF-10-168
150 mm - 6"

SF-10-168 - SF-10-170



GERZOG
SF-10-169
160 mm - 6 1/4"



BUCK
SF-10-170
160 mm - 6 1/4"



LUCAE
SF-10-171
180 mm - 7"



LUCAE
SF-10-172
180 mm - 7"



LUCAE
SF-10-173
190 mm - 7 1/2"



POLITZER
SF-10-174
170 mm - 7 3/4"

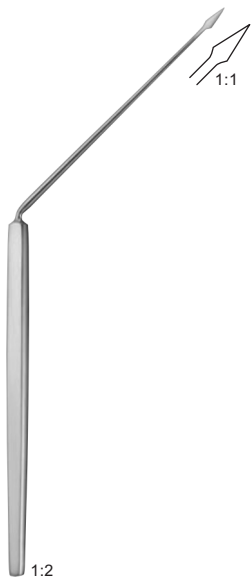

POLITZER
SF-10-175
needle vertical
160 mm - 6 1/4"



SF-10-176
Needle horizontal
160 mm - 6 1/4"

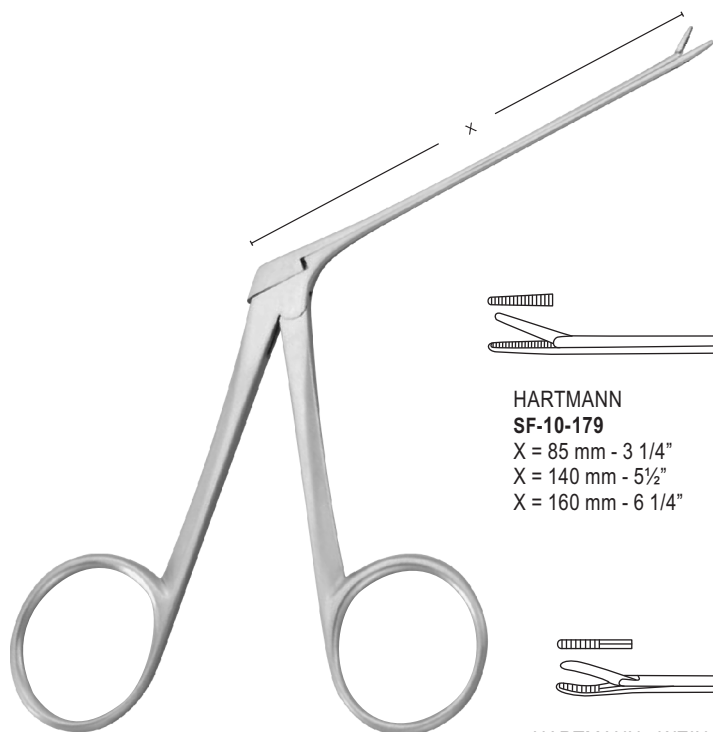

SF-10-177 - SF-10-184

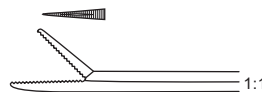

HARTMANN - WULLSTEIN
SF-10-177
X = 85 mm - 3 1/4"



HARTMANN - WULLSTEIN
SF-10-178
X = 85 mm - 3 1/4" 1 mm ø

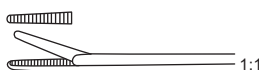

HARTMANN
SF-10-179
X = 85 mm - 3 1/4"
X = 140 mm - 5 1/2"
X = 160 mm - 6 1/4"



HARTMANN
SF-10-180
X = 85 mm - 3 1/4"
X = 140 mm - 5 1/2"

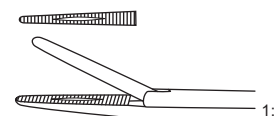

HARTMANN - NOYES
SF-10-181
X = 90 mm - 3 1/2"



HARTMANN - WEINGARTNER
SF-10-182
X = 85 mm - 3 1/4"



HARTMANN
SF-10-183
X = 85 mm - 3 1/4"
2.0 mm ø
2.5 mm ø
3.0 mm ø



STRUEMPEL
SF-10-184
X = 85 mm - 3 1/4"

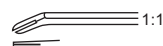

MCGEE
SF-10-185
wire bending forceps
3.5 mm X 0.8 mm



FULLER
SF-10-186
introducing forceps
for teflon prosthesis
80 mm - 3 1/4"

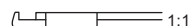

SF-10-187
Up - cutting



SF-10-188
Down - cutting



SF-10-189
Right - cutting

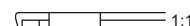

SF-10-190
Left - cutting

DIETER
SF-10-185 - SF-10-190
malleus nipper
X = 80 mm - 3 1/4"



SF-10-191 - SF-10-195

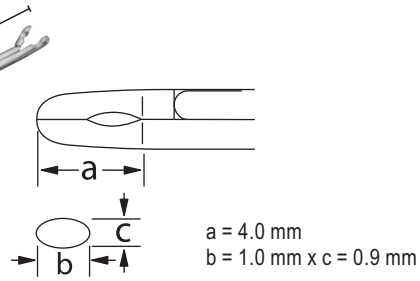

SF-10-191
Straight, oval
X = 75 mm - 3"



SF-10-192
Curved upwards, oval
X = 75 mm - 3"



SF-10-193
Curved to left, oval
X = 75 mm - 3"



SF-10-194
Curved to right, oval
X = 75 mm - 3"



SF-10-195
Curved downwards, oval
X = 75 mm - 3"

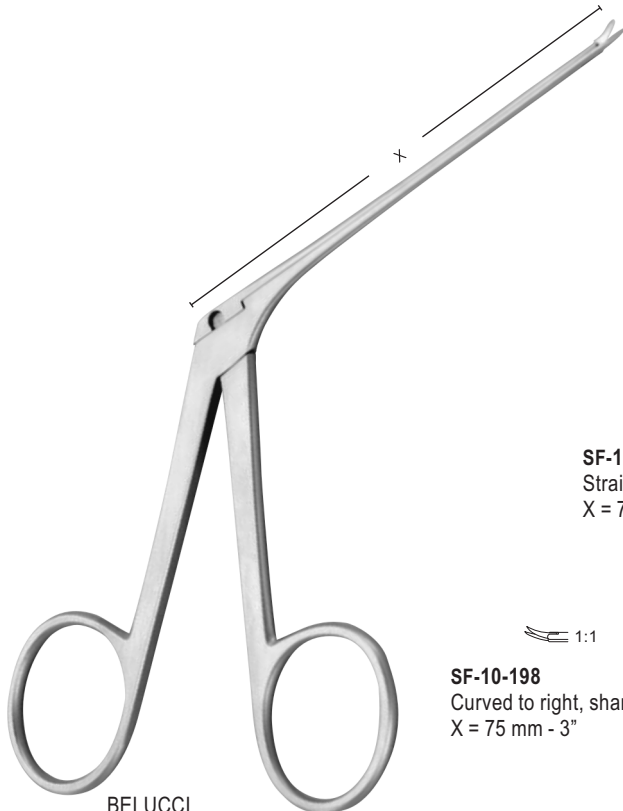

BELUCCI
SF-10-196 - SF-10-200

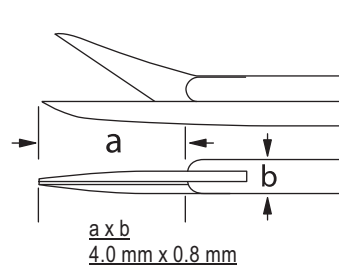

SF-10-196
Straight, sharp/sharp
X = 75 mm - 3"



SF-10-197
Curved upwards, blunt/blunt
X = 75 mm - 3"



SF-10-198
Curved to right, sharp/sharp
X = 75 mm - 3"



SF-10-199
Curved to left, sharp/sharp
X = 75 mm - 3"



SF-10-200
straight, sharp/blunt
X = 75 mm - 3"

MICRO EAR RASPATORIES AND PROBES
 EAR SICKLEKNIVES - CURRCULAR CUTTING KNIFE

www.surgiforce.com



PLESTER
SF-10-201 - SF-10-206
 160 mm - 6 1/4"



WIRE GUIDE
SF-10-201

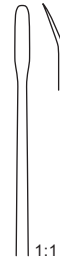

RASPATORY
SF-10-202



RASPATORY
SF-10-203
 1.8 mm



SF-10-204
 Dissector, double
 curved right



SF-10-205
 Instrument for placing
 wire prothesis



SF-10-206
 Dissector, double
 curved left



ROSEN
SF-10-207 - SF-10-213
 160 mm - 6 1/4"

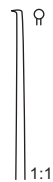

SF-10-207
 Circular cutting knife
 1.5 mm \varnothing 90°



SF-10-208
 Tympanum knife
 45°



SF-10-209
 Lancet knife
 45°



SF-10-210
 Lancet knife



RASPATORY
SF-10-211
 Zollner
 1 mm



SF-10-212
 Sickle knife,
 slightly curved



SF-10-213
 discision knife,
 straight curved



SF-10-214 - SF-10-219



SF-10-214
Needle fine, straight, sharp
160 mm - 6 1/4"



SF-10-215
Needle, slightly curved, sharp
160 mm - 6 1/4"

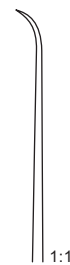

SF-10-216
Needle, strong curved, sharp
160 mm - 6 1/4"

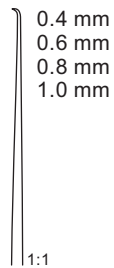

SHAMBAUGH
SF-10-217
45° Hook, angled
160 mm - 6 1/4"



PLESTER
SF-10-218
0.4 mm - 90°
foot plate hook, angled, blunt
160 mm - 6 1/4"



PLESTER
SF-10-219
0.4 mm - 45°
Antrum hook, angled, blunt
160 mm - 6 1/4"



SF-10-220 - SF-10-223



FISCH
SF-10-220
Angled to the right
155 mm - 6"



SF-10-221
Angled to the left
155 mm - 6"

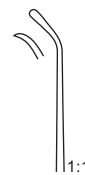

SF-10-222
Angled to the right
155 mm - 6"



SF-10-223
Angled to the left
155 mm - 6"



HOUSE
SF-10-224
spoon, strong curved
spoon, slightly curves
170 mm - 6 3/4"



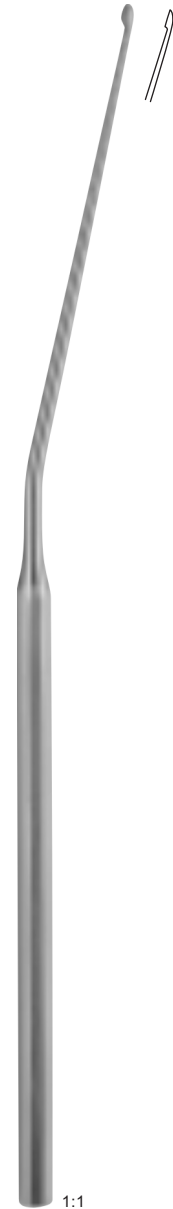

SHEA
SF-10-225
straight
160 mm - 6 1/4"
1.5 mm X 2.5 mm



SHEA
SF-10-226
curved
160 mm - 6 1/4"
1.5 mm X 2.5 mm







1:2
CITELLI
SF-10-227 - SF-10-229
X = 60 mm
170 mm - 6 3/4"

- | | | |
|---|---|---|
| 
SF-10-227
1.5 mm | 
SF-10-228
2.2 mm | 
SF-10-229
3.0 mm |
|---|---|---|



1:2
SF-10-230 - SF-10-233
200 mm - 8"
X = 80 mm

- | | |
|---|---|
| 
SF-10-230
3 X 3 mm | 
SF-10-231
4 X 4 mm |
| 
SF-10-232
5 X 5 mm | 
SF-10-233
6 X 6 mm |

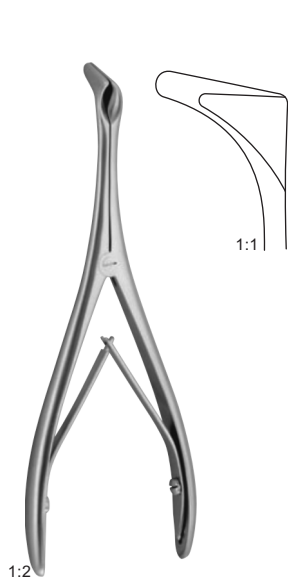

TIECK - HALLE
SF-10-234
 for babies
 135 mm - 5 1/4"



BECKMANN
SF-10-235
 150 mm - 6"



MOD. WIEN
SF-10-236
 145 mm - 5 3/4"

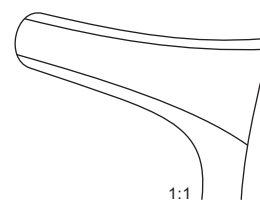
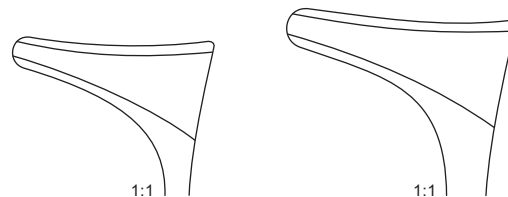

SF-10-237 - SF-10-240
KILLIAN
 130 mm - 5"

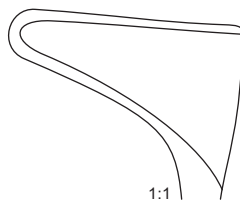

SF-10-237
 X = 35 mm

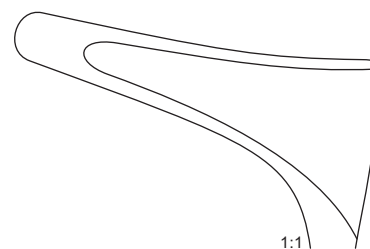

SF-10-238
 X = 50 mm

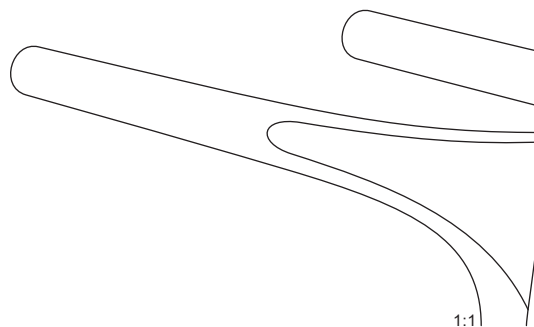

SF-10-239
 X = 75 mm

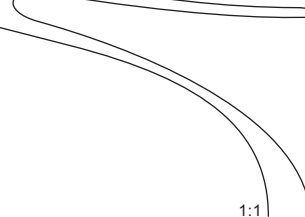

SF-10-240
 X = 90 mm



WESTMACOTT
SF-10-241
200 mm - 8"

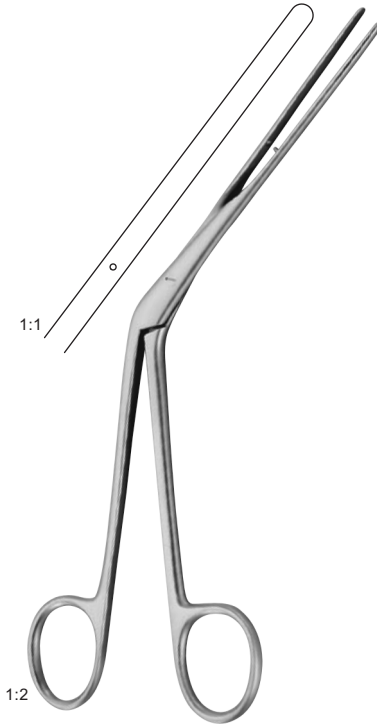

LUBET - BARBON
SF-10-242
200 mm - 8"



HARTMANN
SF-10-243
160 mm - 6 1/4"
200 mm - 8"

NASAL DRESSING FORCEPS

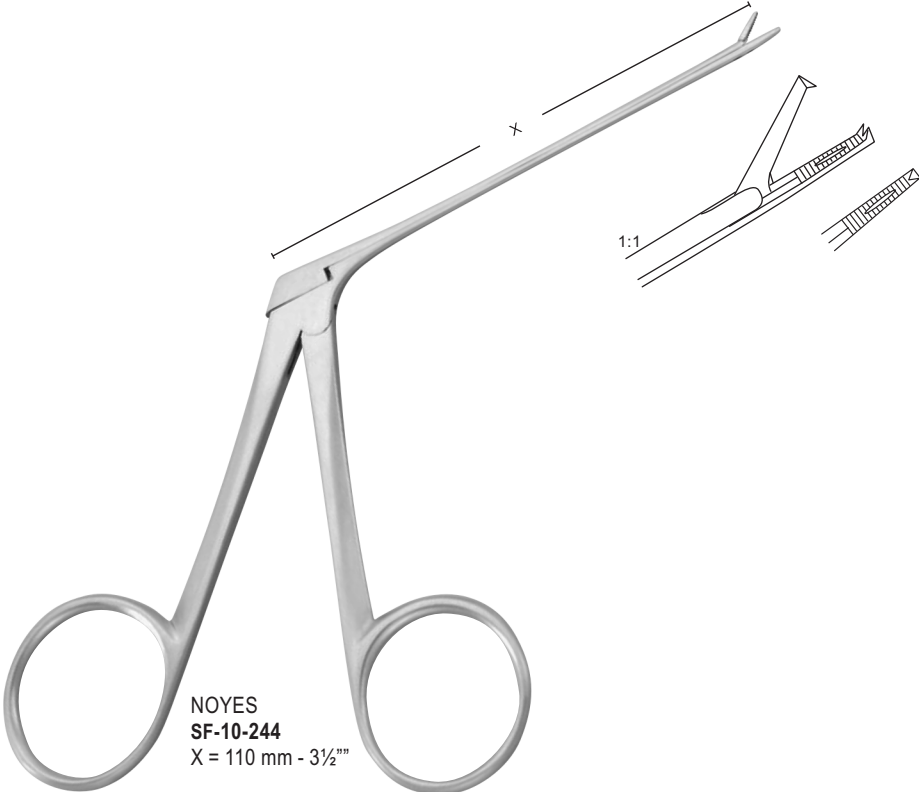

NOYES
SF-10-244
X = 110 mm - 3 1/2"

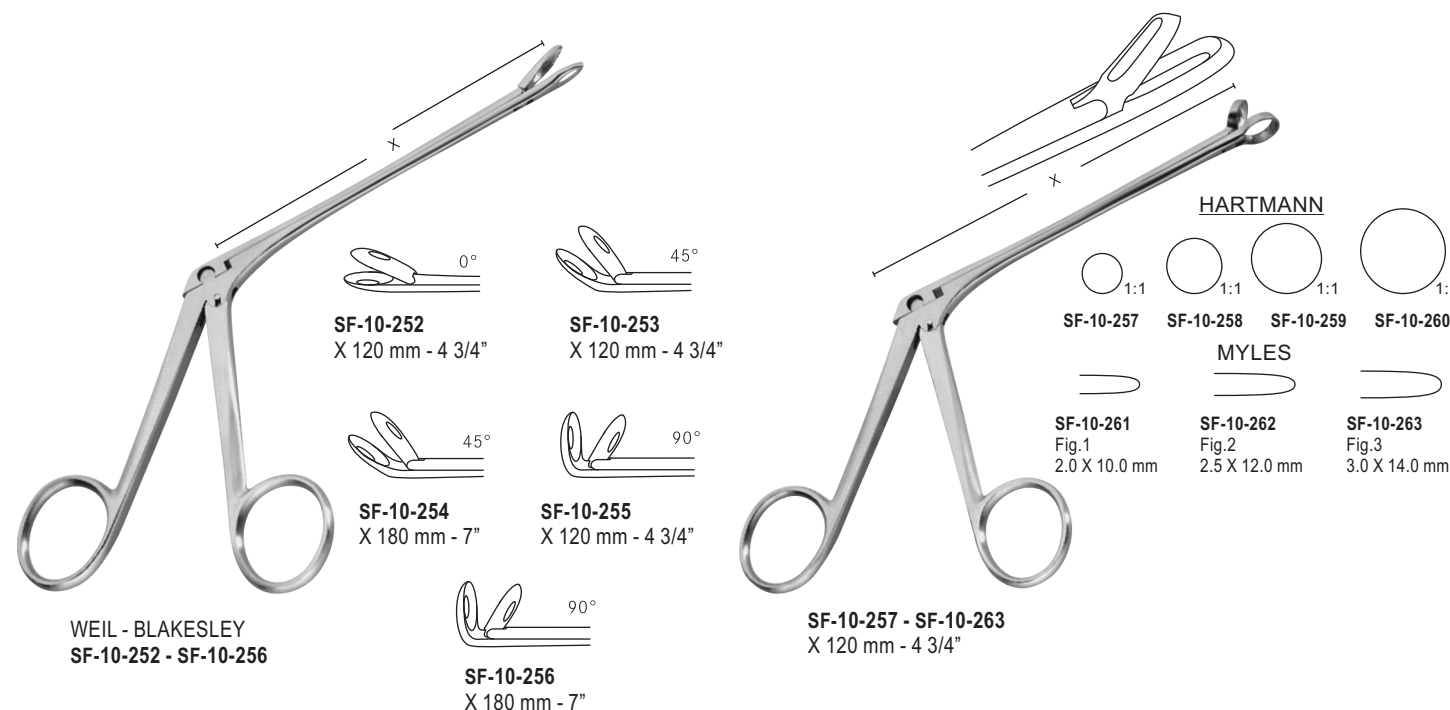
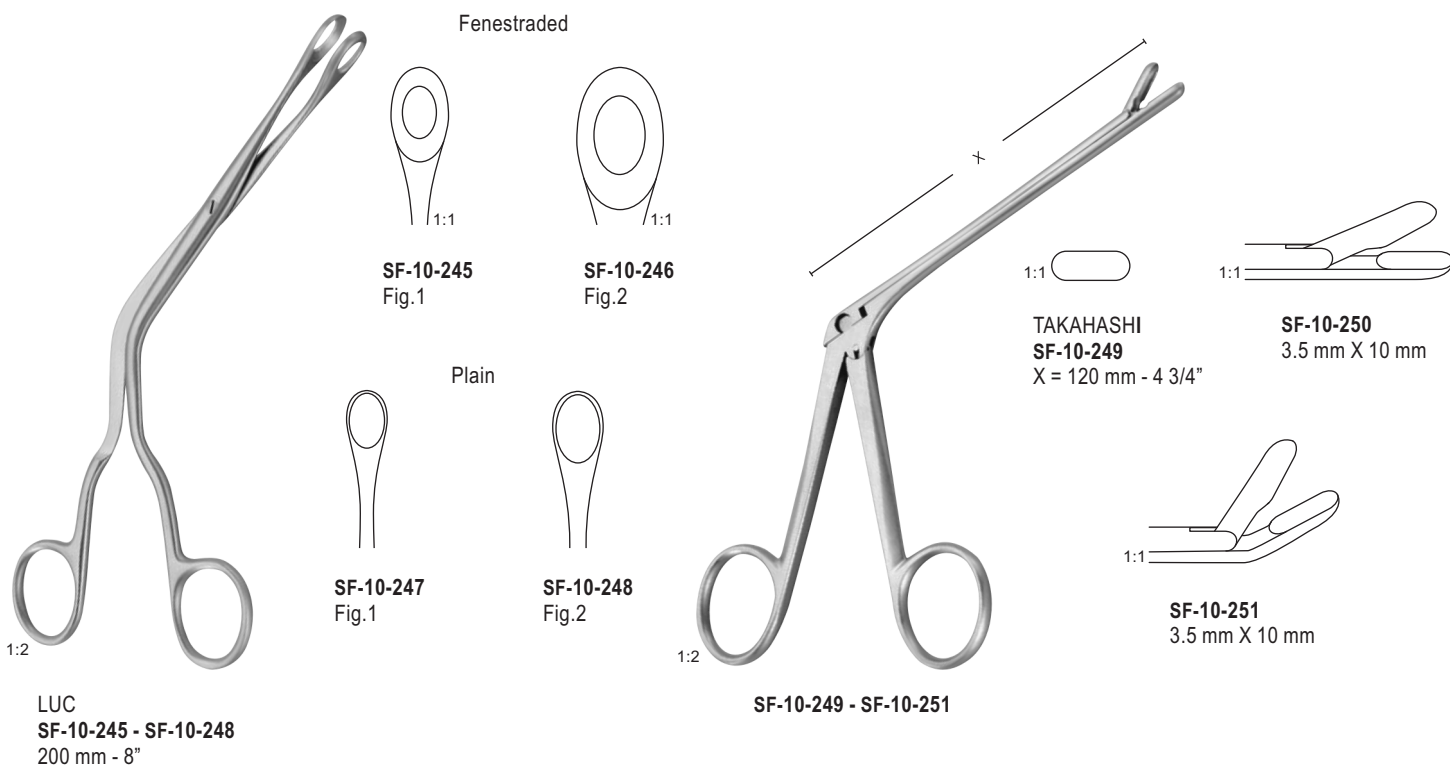

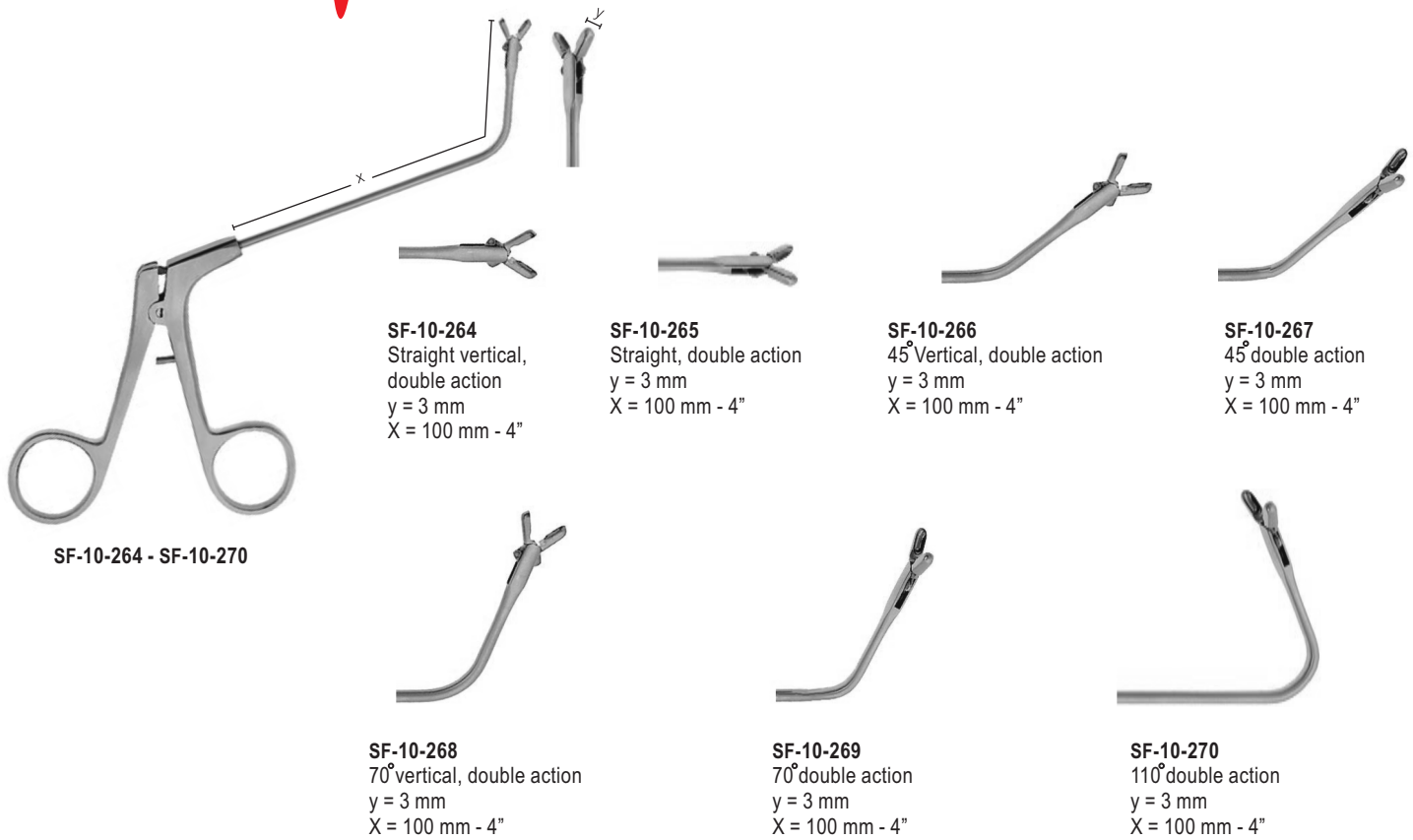

SF-10-264 - SF-10-270

CIRCULAR FORCEPS AND ANTRUM PUNCH

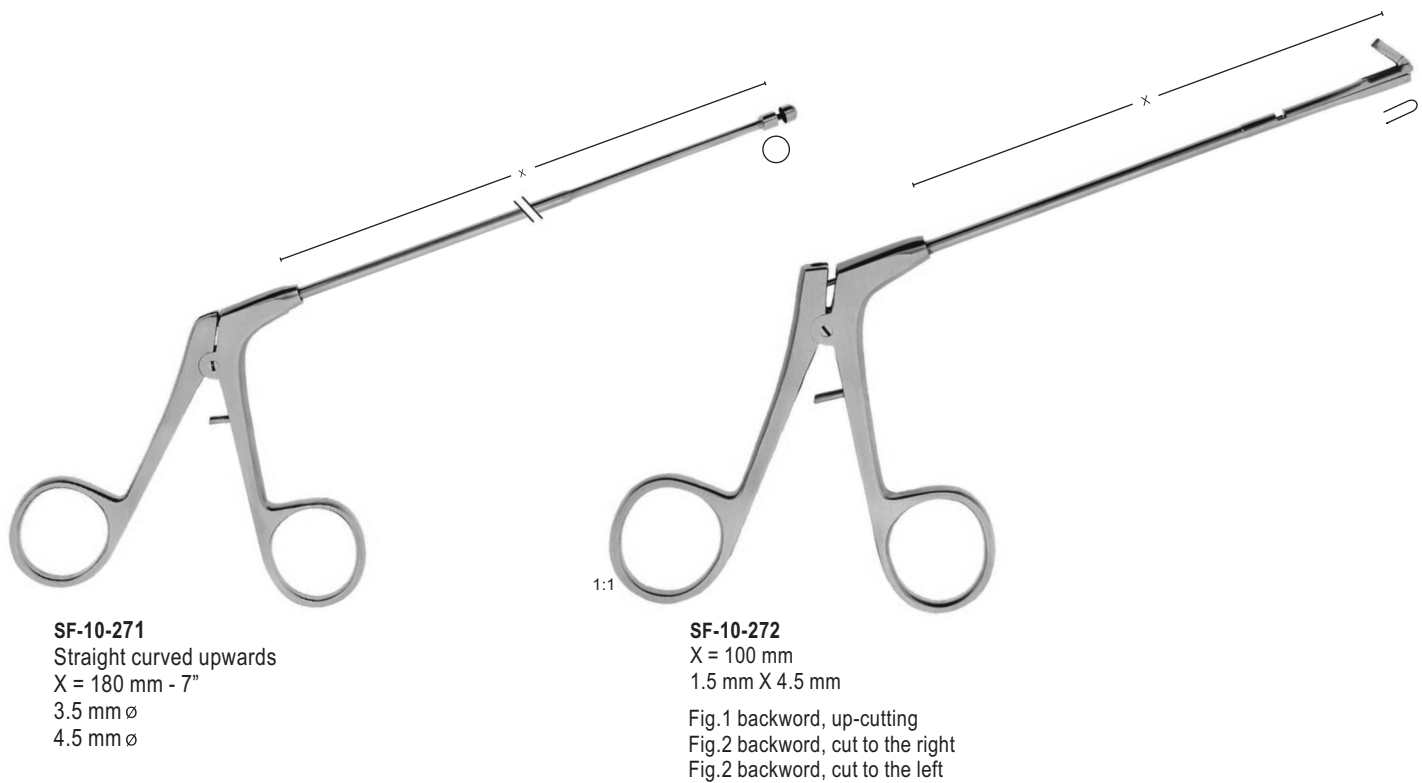



1:2
FREER
SF-10-273
210 mm - 8 1/4"



1:2
FREER
SF-10-274
210 mm - 8 1/4"



1:2
SICKLE KNIFE
SF-10-275
200 mm - 8"



1:2
BRUNINGS
SF-10-276
230 mm - 9"



1:2
ABRAHAM
SF-10-277
220 mm - 8 3/4"



1:2
FISCHER
SF-10-278
230 mm - 9"



1:2
SHARP
SF-10-279
200 mm - 8"

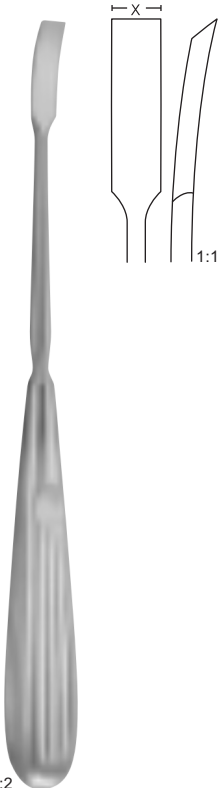

1:2

LEMPERT
SF-10-280
200 mm - 8"
X = 6 mm

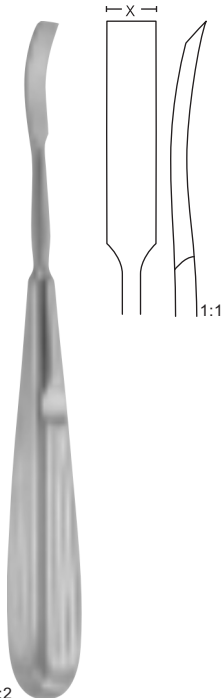

1:2

LEMPERT
SF-10-281
180 mm - 7"



1:2

FREER
SF-10-282
160 mm - 6 1/4"
X = 4 mm

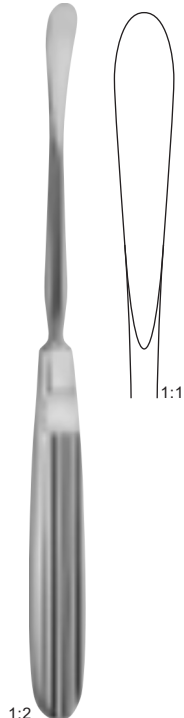

1:2

COTTLE
SF-10-283
sharp
190 mm - 7 1/2"
X = 8 mm

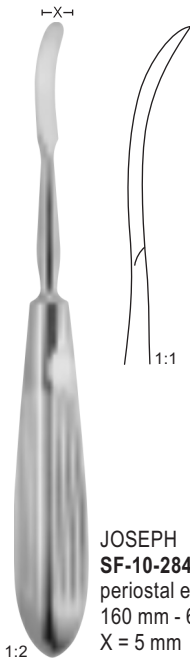

1:2

JOSEPH
SF-10-284
periosteal elevators
160 mm - 6 1/4"
X = 5 mm

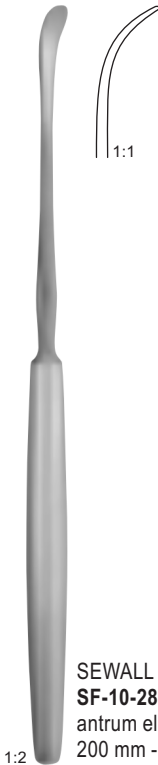

1:2

SEWALL
SF-10-285
antrum elevators
200 mm - 8"

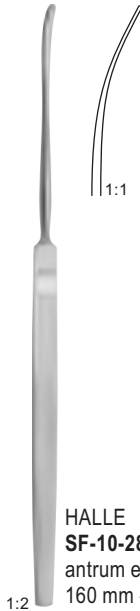

1:2

HALLE
SF-10-286
antrum elevators
160 mm - 6 1/4"

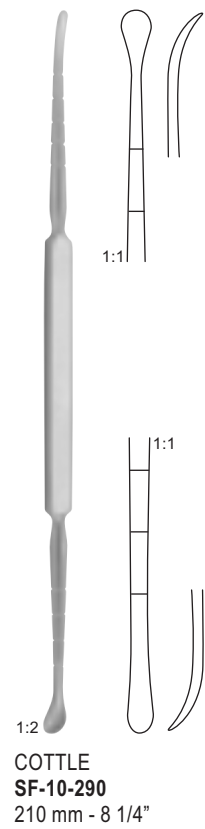
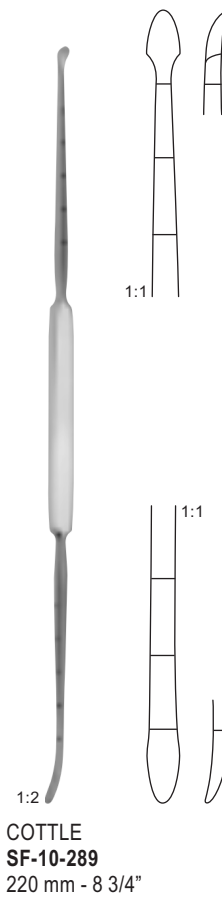
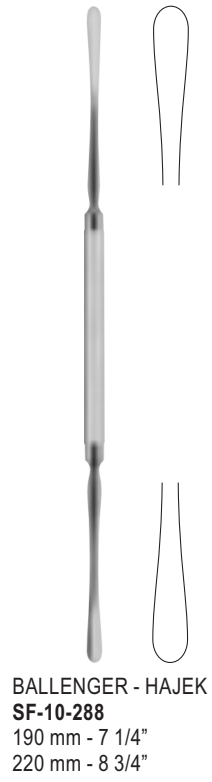
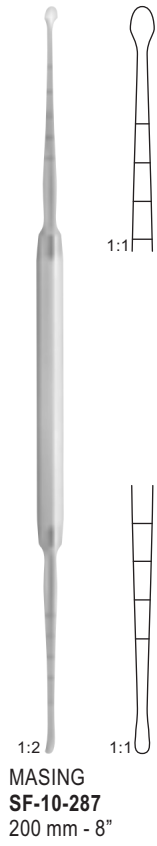

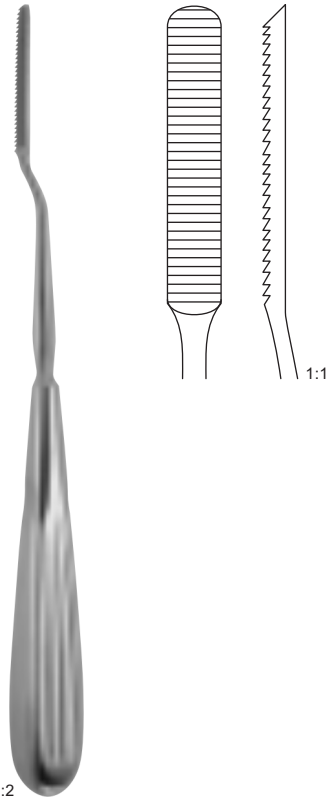

COTTLE
SF-10-291
210 mm - 8 1/4"

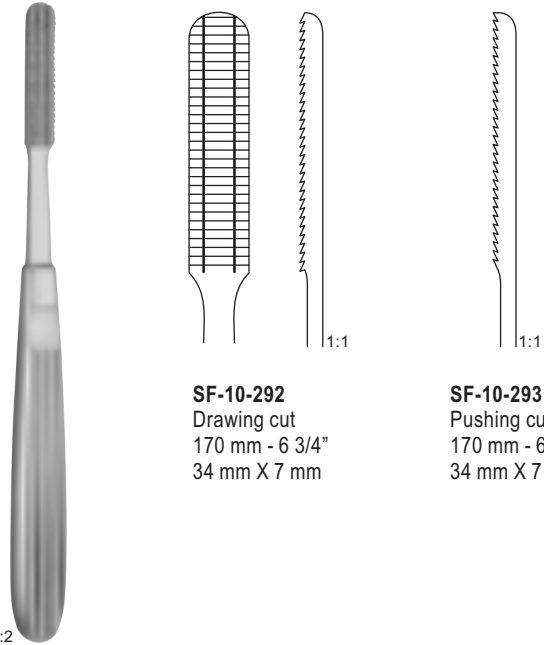

SF-10-292
Drawing cut
170 mm - 6 3/4"
34 mm X 7 mm

SF-10-293
Pushing cut
170 mm - 6 3/4"
34 mm X 7 mm

MALTZ
SF-10-292 - SF-10-293

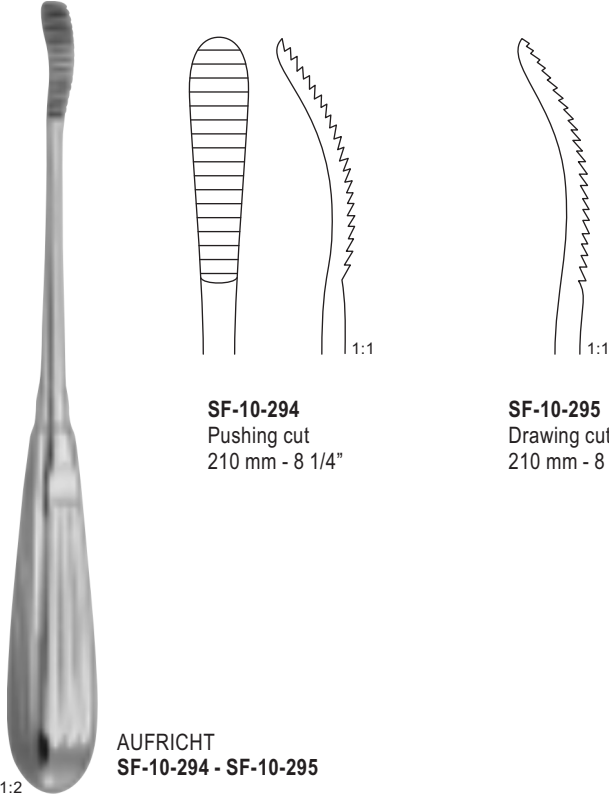

SF-10-294
Pushing cut
210 mm - 8 1/4"

SF-10-295
Drawing cut
210 mm - 8 1/4"

AUFRICHT
SF-10-294 - SF-10-295



SF-10-296 - 205
200 mm - 8"



FOMON
Teeth

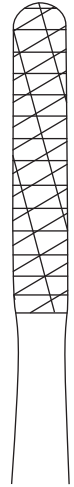

SF-10-296
Fig.1
12

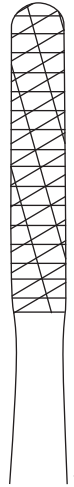

SF-10-297
Fig.3
16

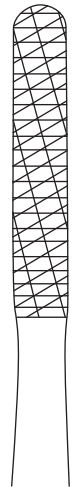

SF-10-298
Fig.5
24



SF-10-299
Fig.7
36



SF-10-300
Fig.9
52



FOMON TC
Teeth

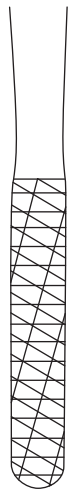

SF-10-301
Fig.2
14



SF-10-302
Fig.4
20



SF-10-303
Fig.6
30

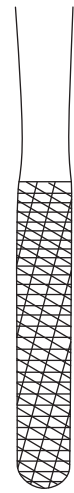

SF-10-304
Fig.8
44



SF-10-305
Fig.10
62



SF-10-306 - SF-10-308



1:2
SF-10-306
Straight

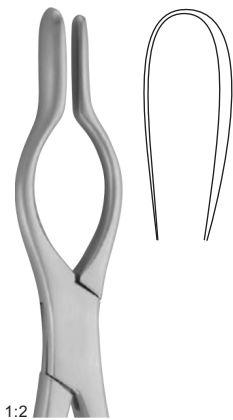

1:2
SF-10-307
Left

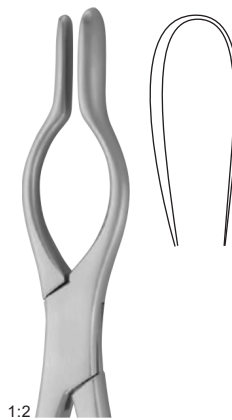

1:2
SF-10-308
Right

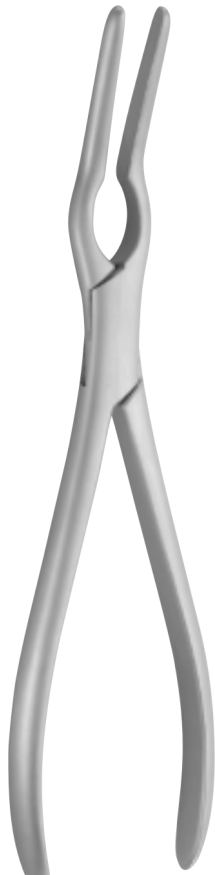

1:2
ASCH
SF-10-309
230 mm - 9"

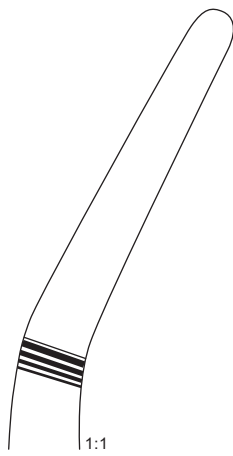

1:1

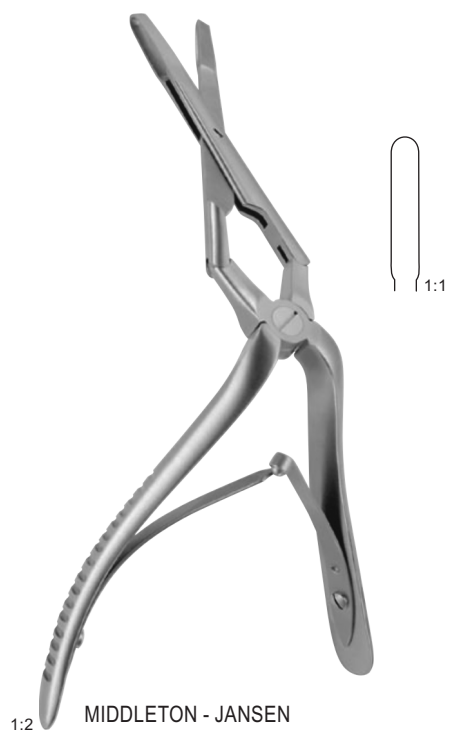

1:2 MIDDLETON - JANSEN
SF-10-310
190 mm - 7½"

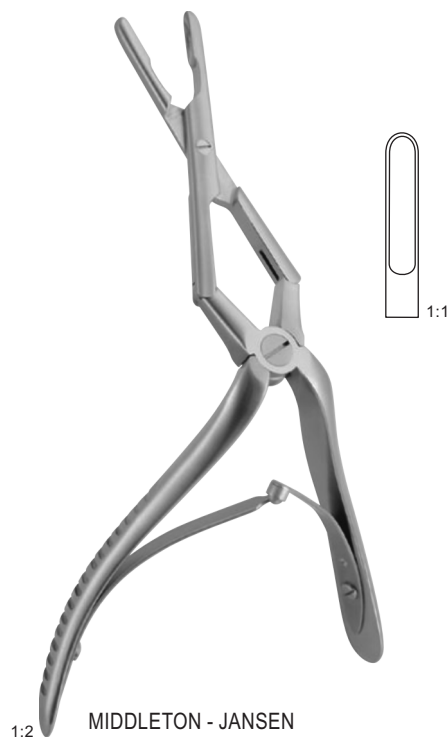

1:2 MIDDLETON - JANSEN
SF-10-311
190mm - 7½"

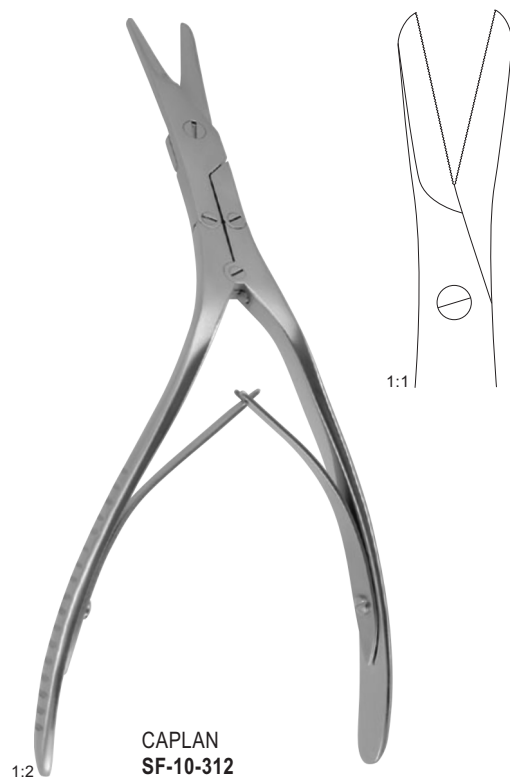

1:2 CAPLAN
SF-10-312
toothed
200 mm - 8"

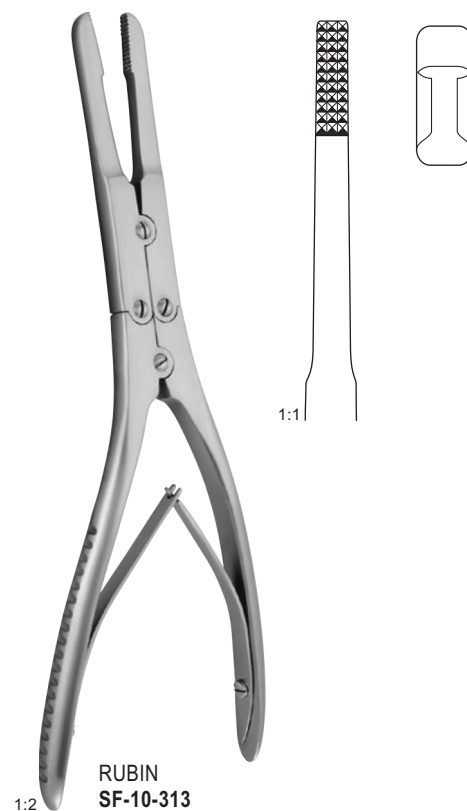

1:2 RUBIN
SF-10-313
protection cap
210 mm - 8 1/4"

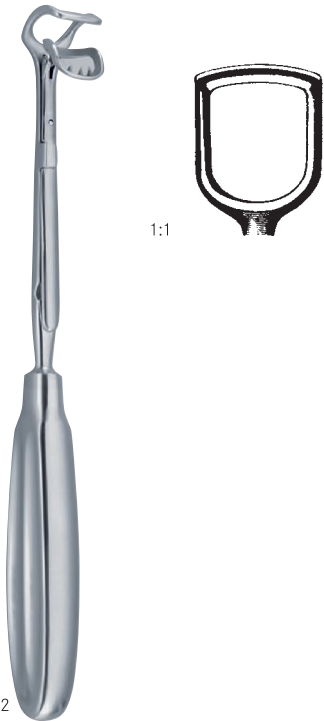

1:2
ST. CLAIR-THOMSON
SF-10-314
210 mm - 8 1/4"

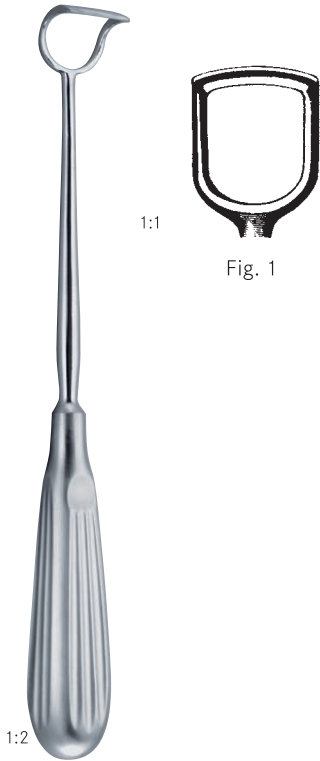

1:2
BARNHILL
SF-10-315
220 mm - 8 3/4"



BECKMANN
SF-10-316
Straight Curved
220 mm - 8 3/4"

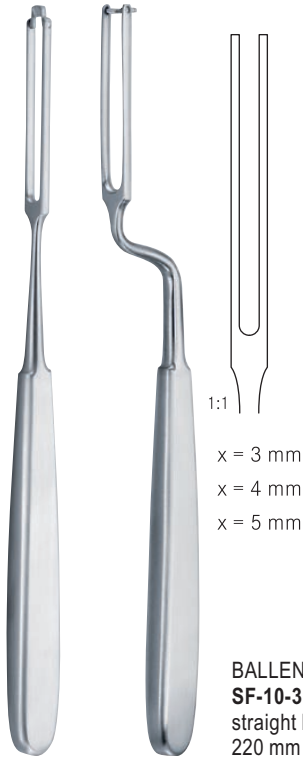

1:1
x = 3 mm
x = 4 mm
x = 5 mm
BALLENGER
SF-10-317
straight bayonet
220 mm - 8"



1:2

MOLT
SF-10-318
for children
110 mm - 4 1/4"



1:2

MOLT
SF-10-319
for adults
140 mm - 5 1/2"



1:2

DENHART
SF-10-320
120 mm - 4 3/4"



1:2

FERGUSON - ACKLAND
SF-10-321
145 mm - 5 3/4"



ROSER - KÖNIG
SF-10-322
160 mm - 6 1/4"
190 mm - 7 1/2"



- SF-10-33 Fig. 00 8 mm Ø
- SF-10-324 Fig. 0 10 mm Ø
- SF-10-325 Fig. 1 12 mm Ø
- SF-10-326 Fig. 2 14 mm Ø
- SF-10-327 Fig. 3 16 mm Ø
- SF-10-328 Fig. 4 18 mm Ø
- SF-10-329 Fig. 5 20 mm Ø
- SF-10-330 Fig. 6 22 mm Ø
- SF-10-331 Fig. 7 24 mm Ø
- SF-10-332 Fig. 8 26 mm Ø
- SF-10-333 Fig. 9 28 mm Ø
- SF-10-333 Fig. 10 30 mm Ø

SF-10-323 - SF-10-333



1:2
SF-10-334
100 mm - 4"



- SF-10-335 Fig. 00 8 mm Ø
- SF-10-336 Fig. 0 10 mm Ø
- SF-10-337 Fig. 1 12 mm Ø
- SF-10-338 Fig. 2 14 mm Ø
- SF-10-339 Fig. 3 16 mm Ø
- SF-10-340 Fig. 4 18 mm Ø
- SF-10-341 Fig. 5 20 mm Ø
- SF-10-342 Fig. 6 22 mm Ø
- SF-10-343 Fig. 7 24 mm Ø
- SF-10-344 Fig. 8 26 mm Ø
- SF-10-345 Fig. 9 28 mm Ø
- SF-10-346 Fig. 10 30 mm Ø

SF-10-335 - SF-10-346



- SF-10-347 10 mm Ø
- SF-10-348 12 mm Ø
- SF-10-349 14 mm Ø
- SF-10-350 16 mm Ø
- SF-10-351 18 mm Ø

MICHEL
SF-10-347 - SF-10-351
moveable mirror
250 mm - 9 3/4"

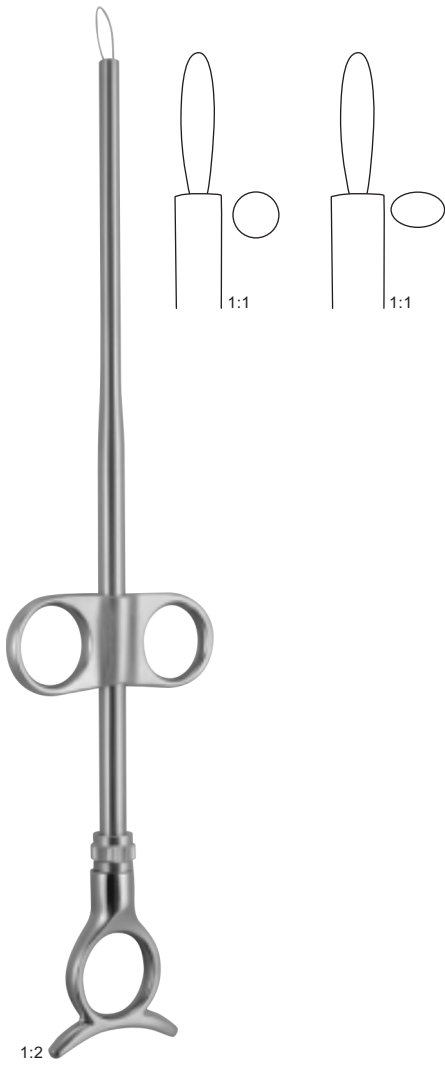

EVES
SF-10-352
 280 mm - 11"



EVES
SF-10-353
 280 mm - 11"



BRUENINGS
SF-10-354
 280 mm - 11"



SF-10-355
 10 mm - 33 ft.
 0.3 mm Ø
 0.4 mm Ø

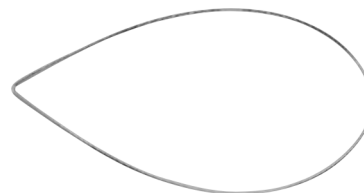

SF-10-356
 Package of 100 pieces
 40 mm
 50 mm



1:2
COLVER
SF-10-357
straight curved
190 mm - 7½"



1:2
WHITE
SF-10-358
180 mm - 7"
230 mm - 9"

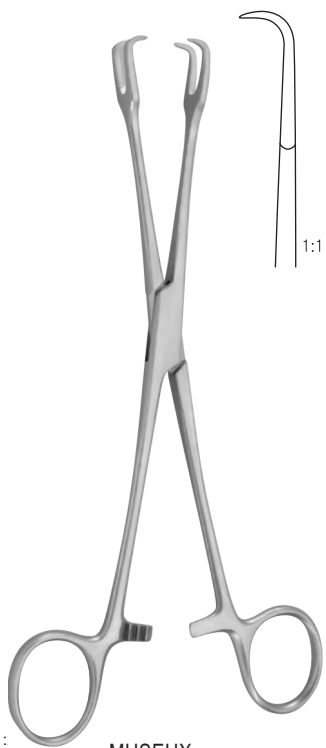

1:
MUSEUX
SF-10-359
tonsil holding forceps
200 mm - 8"



1:2
JACKSON
SF-10-360
laryngeal forceps
220 mm - 8½"

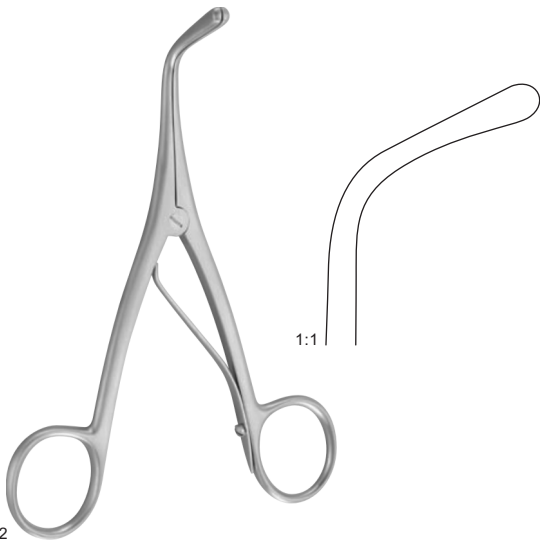

1:2
TROUSSEAU
SF-10-361
140 mm - 5½"

TRACHEA DILATOR

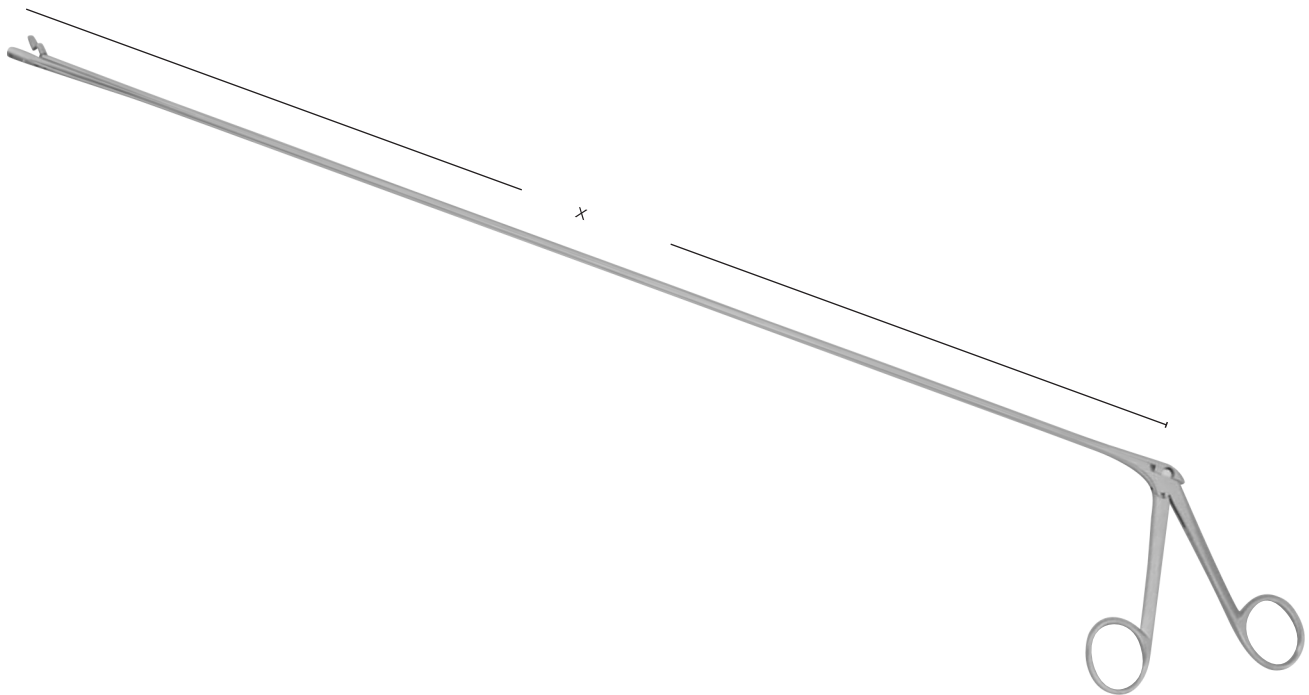

SF-10-362



SF-10-363



SF-10-364



SF-10-365

CHEVALIER - JACKSON
SF-10-32 - SF-10-368
X = 300 mm - 12"
X = 400 mm - 16"
X = 500 mm - 20"
X = 600 mm - 23½"



SF-10-366



SF-10-367



SF-10-368

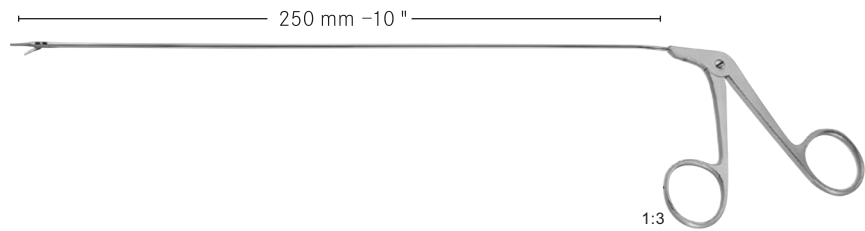

SF-10-39 - SF-10-385

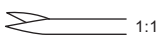

SF-10-369
Straight



SF-10-370
Straight horizontal



SF-10-371
Angled up horizontal

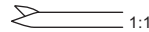

SF-10-372
Curved right

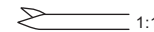

SF-10-373
Curved left



SF-10-374
Angled up



SF-10-375
Straight, serrated



SF-10-376
Straight horizontal



SF-10-377
Angled up horizontal



SF-10-378
Curved right



SF-10-379
Curved left



SF-10-380
Straight



SF-10-381
Angled up
02.5 mm



SF-10-382
Angled up horizontal



SF-10-383
Curved right



SF-10-384
Curved left

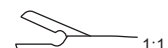

SF-10-385
Oval
03.5 mm



DAVIS-BOYLE
SF-10-386 - SF-10-388
 complete, consisting of frame
 and 5 tongue depressors no. 1-5

SF-10-386
 Frame for Mouth Gag

SF-10-387
 14.5 cm
 Frame for Mouth Gag with joint

SF-10-388
 14.5 cm
 Silicone inlay



Fig. 1
SF-10-389 - SF-10-392
 110 X 28 mm



Fig. 2
SF-10-389
 95 X 27 mm



Fig. 3
SF-10-390
 80 X 27 mm



Fig. 4
SF-10-391
 65 X 26 mm



Fig. 5
SF-10-392
 without suction tube
 30 X 20 mm



NEUKAM
SF-10-393 - 297
complete, with frame
and 3 tongue depressors

NEUKAM
SF-10-393
Frame for Mouth Gag, only



SF-10-394
Tongue Depressor
fenestrated blade for suction

Fig. 1
SF-10-395

Fig. 2
SF-10-396

Fig. 3
SF-10-397



KILNER-DOUGHTY
SF-10-38 - SF-10-304
complete, with frame, 3 tongue depressors,
2 toothplates and 1 palate plate



SF-10-399
Palate plate

KILNER-DOUGHTY
SF-10-400
14.5 cm
Frame for Mouth Gag

KILNER-DOUGHTY
SF-10-401
Tongue Depressor
fenestrated blade for suction



Fig. 1
SF-10-402
68 X 30 mm

Fig. 2
SF-10-403
77 X 34 mm

Fig. 3
SF-10-404
82 X 39 mm

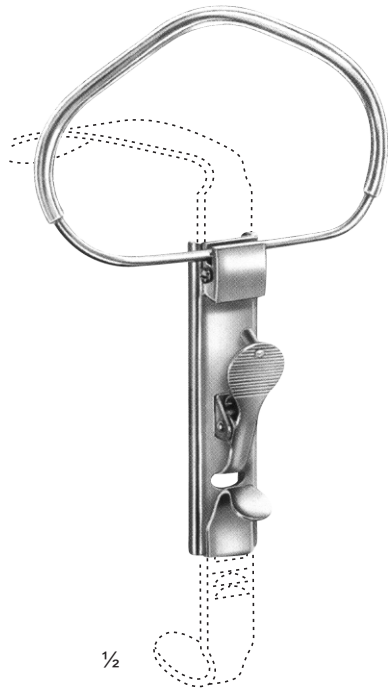

MCLVOR
SF-10-405 - 309
complete, with 3 tongue depressors

MCLVOR
SF-10-405
Frame for Mouth Gag

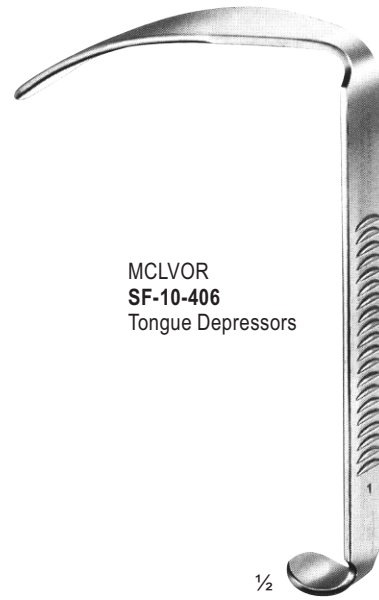

MCLVOR
SF-10-406
Tongue Depressors

Fig. 1
SF-10-407
100 X 25 mm

Fig. 2
SF-10-408
85 X 25 mm

Fig. 3
SF-10-409
75 X 25 mm

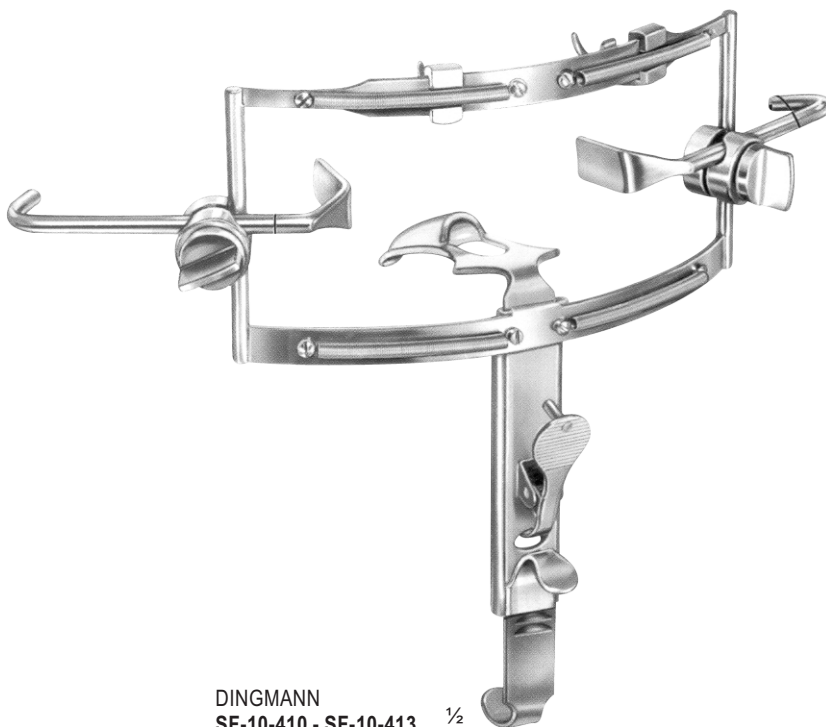

DINGMANN
SF-10-410 - SF-10-413 1/2
complete, with frame, 3 tongue depressors,
and 2 adjustable lateral blades

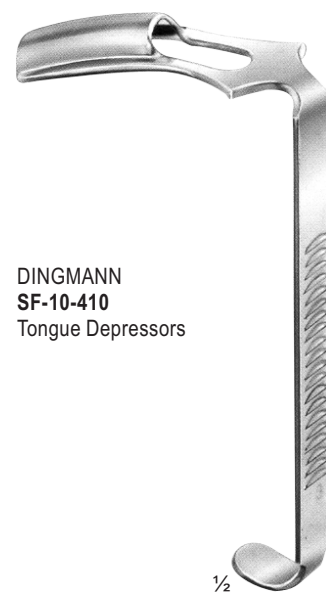

DINGMANN
SF-10-410
Tongue Depressors

Fig. 1
SF-10-411
62 X 26 mm

Fig. 2
SF-10-412
65 X 30 mm

Fig. 3
SF-10-413
78 X 32 mm



SF-10-414
Fig.1
20 mm X 70 mm



SF-10-415
Fig.2
30 mm X 80 mm



SF-10-416
Fig.3
33 mm X 95 mm



SF-10-417
Handle

NEGUS
SF-10-414 - SF-10-417
complete
handle

TONSIL INSTRUMENTS

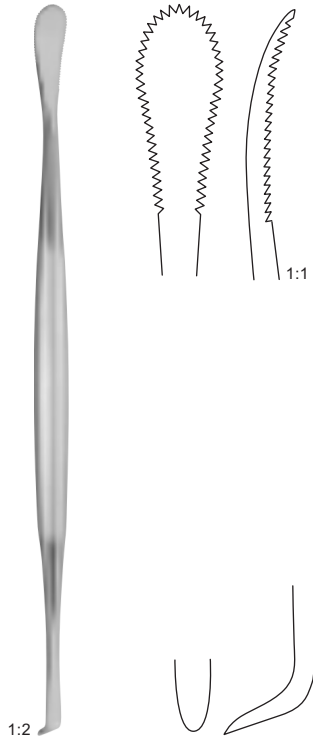

HENKE
SF-10-418
tonsil dissector
230 mm - 9"

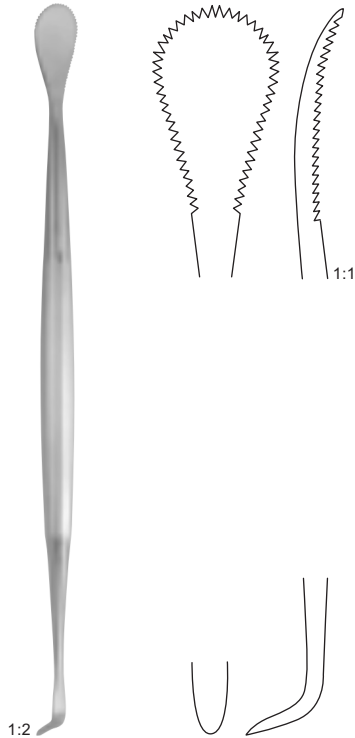

HENKE
SF-10-419
tonsil dissector
230 mm - 9"

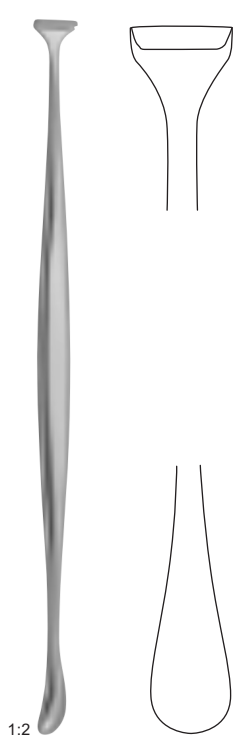

HURD
SF-10-420
tonsil dissector
225 mm - 8 3/4"



JENNINGS
SF-10-421 - SF-10-424
SF-10-421 10.5 cm
SF-10-422 12.5 cm
SF-10-423 14.5 cm
SF-10-424 16.5 cm

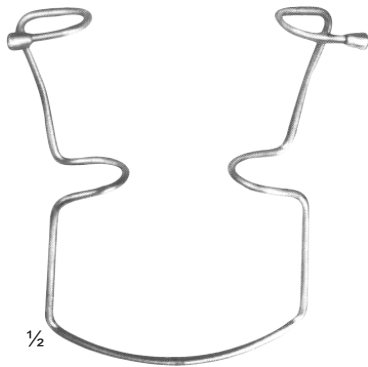

ORINGER
SF-10-425 - SF-10-427
9.5 cm
self retaining, for children

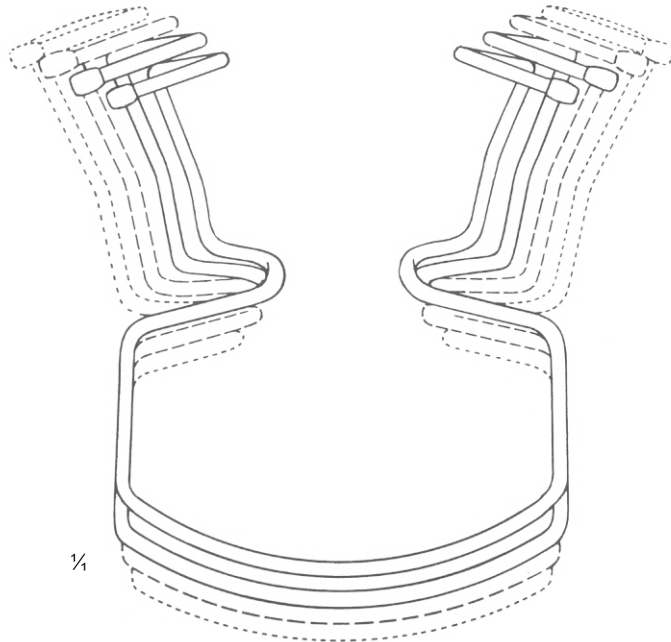
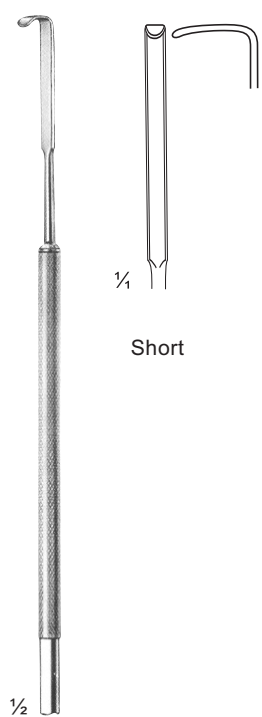

Fig. 1
SF-10-425
10 cm

Fig. 2
SF-10-426
10.5 cm

Fig. 3
SF-10-427
11 cm



Short

SALYER
SF-10-428
185 mm
Cleft Palate
Hooklets

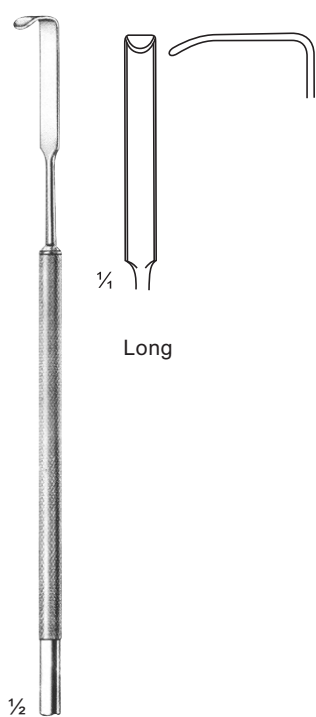

Long

SALYER
SF-10-429
185 mm
Cleft Palate
Hooklet

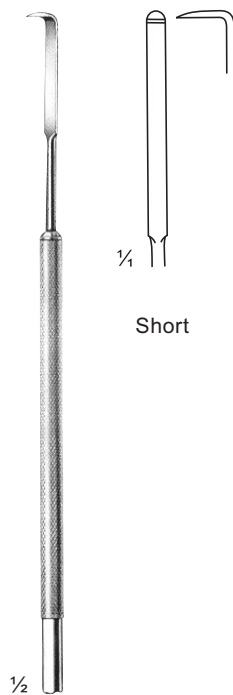

Short

SALYER
SF-10-430
180 mm
Cleft Palate
Dissector

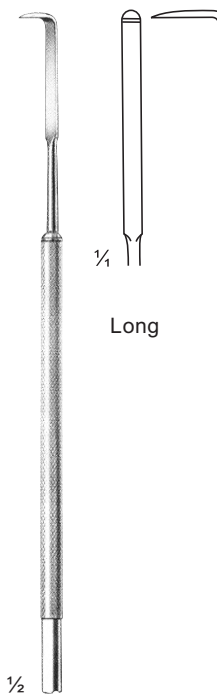

Long

SALYER
SF-10-431
180 mm
Cleft Palate
Dissector

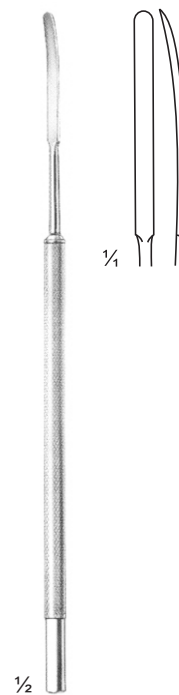

SALYER
SF-10-432
180 mm
Cleft Palate
Instruments

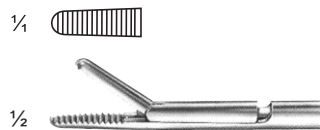

FRAENKEL
SF-10-433
for interchangeable tubes

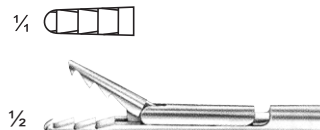

SEIFFERT
SF-10-434
for interchangeable tubes

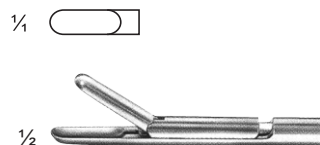

FRAENKEL
SF-10-435
for interchangeable tubes

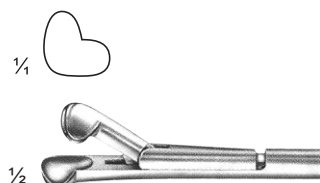

SCHEINMANN
SF-10-436
for interchangeable tubes

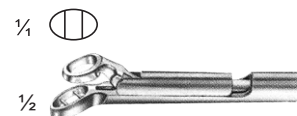

SCHEINMANN
SF-10-437
for interchangeable tubes



BRÜNINGS
SF-10-438 - SF-10-439
for interchangeable tubes

1/4 Fig. 2
SF-10-438

1/4 Fig. 3
SF-10-439

1/4 Fig. 2
SF-10-440

1/4 Fig. 3
SF-10-441



BRÜNINGS
SF-10-440 - SF-10-441
for interchangeable tubes

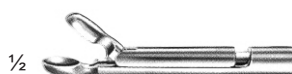

LANGE
SF-10-442
for interchangeable tubes

1/4 Fig. 1
SF-10-442



Fig. 1
SF-10-443



Fig. 2
SF-10-444



KRAUSE
SF-10-443 - SF-10-444
for interchangeable tubes



1/4

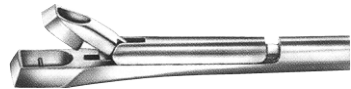

KRAUSE
SF-10-445
for interchangeable tubes



Fig. 1
SF-10-446



Fig. 2
SF-10-447



CORDES
SF-10-446 - SF-10-449
for interchangeable tubes



1/4



SCHUMACHER
SF-10-450
for interchangeable tubes



Fig. 3
SF-10-448



Fig. 4
SF-10-449



Fig. 1
SF-10-451



Fig. 2
SF-10-452



CORDES
SF-10-41 - SF-10-452
for interchangeable tubes



1/4



CORDES
SF-10-453
for interchangeable tubes

1/4



ROSENBERG
SF-10-454
for interchangeable tubes



Surgiforce Instruments



Opposite Surgical Association,
Malkay Kalan, Marala Road,
Sialkot-51050 Pakistan.



+92 523 559131



info@surgiforce.com
sales@surgiforce.com



www.surgiforce.com



Our Certifications:

ISO 9001

CE Certified

EN 13485:2012

ISO 7153-1

ISO 7151

ISO 17664:2004

ISO 13402

ISO 15223



No.3012922148