

Page 103-111

- Sponge and Dressing Forceps
- Washing Forceps
- Organ and Tissue Grasping Forceps
- Towel Clamps

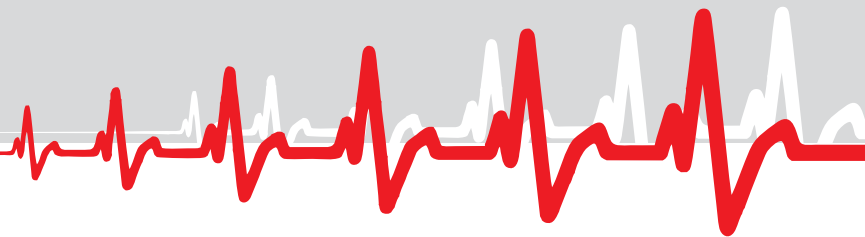

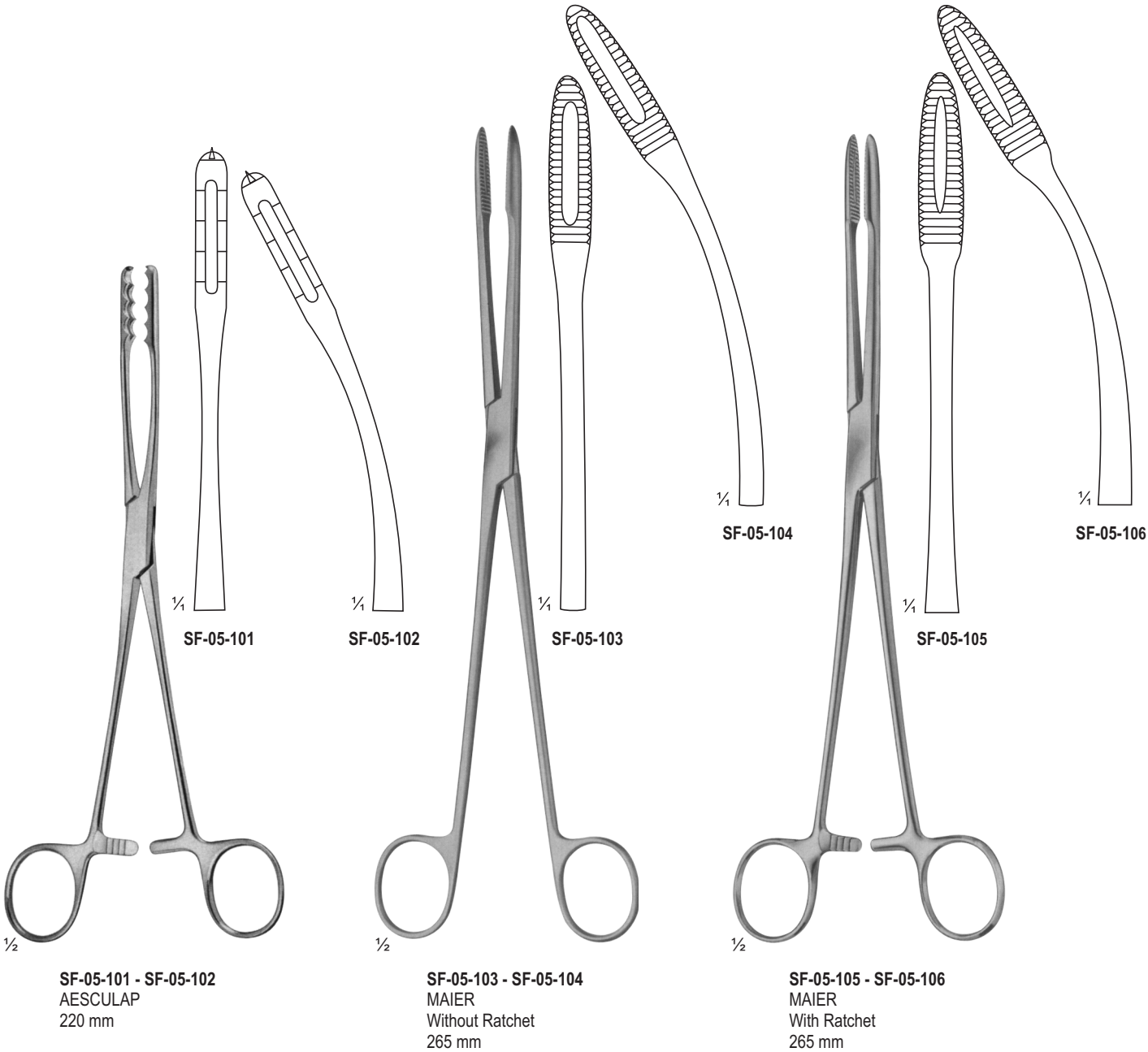

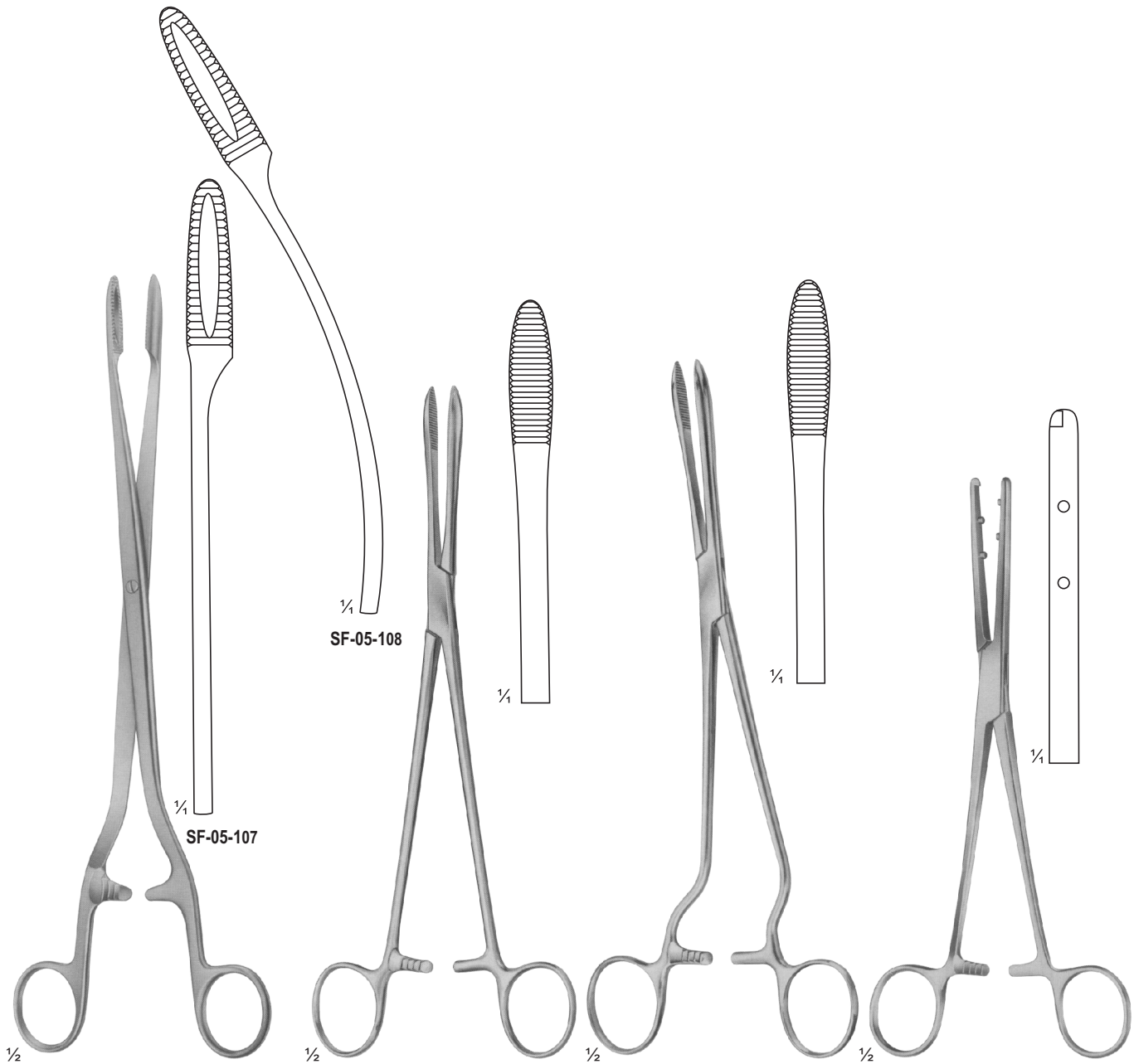

SF-05-107 - SF-05-108
SIMS-MAIER
280 mm

SF-05-109
COLLIN
240 mm

SF-05-110
CHERON
Handles Laterally Angled
240 mm

SF-05-111
EMMET
210 mm

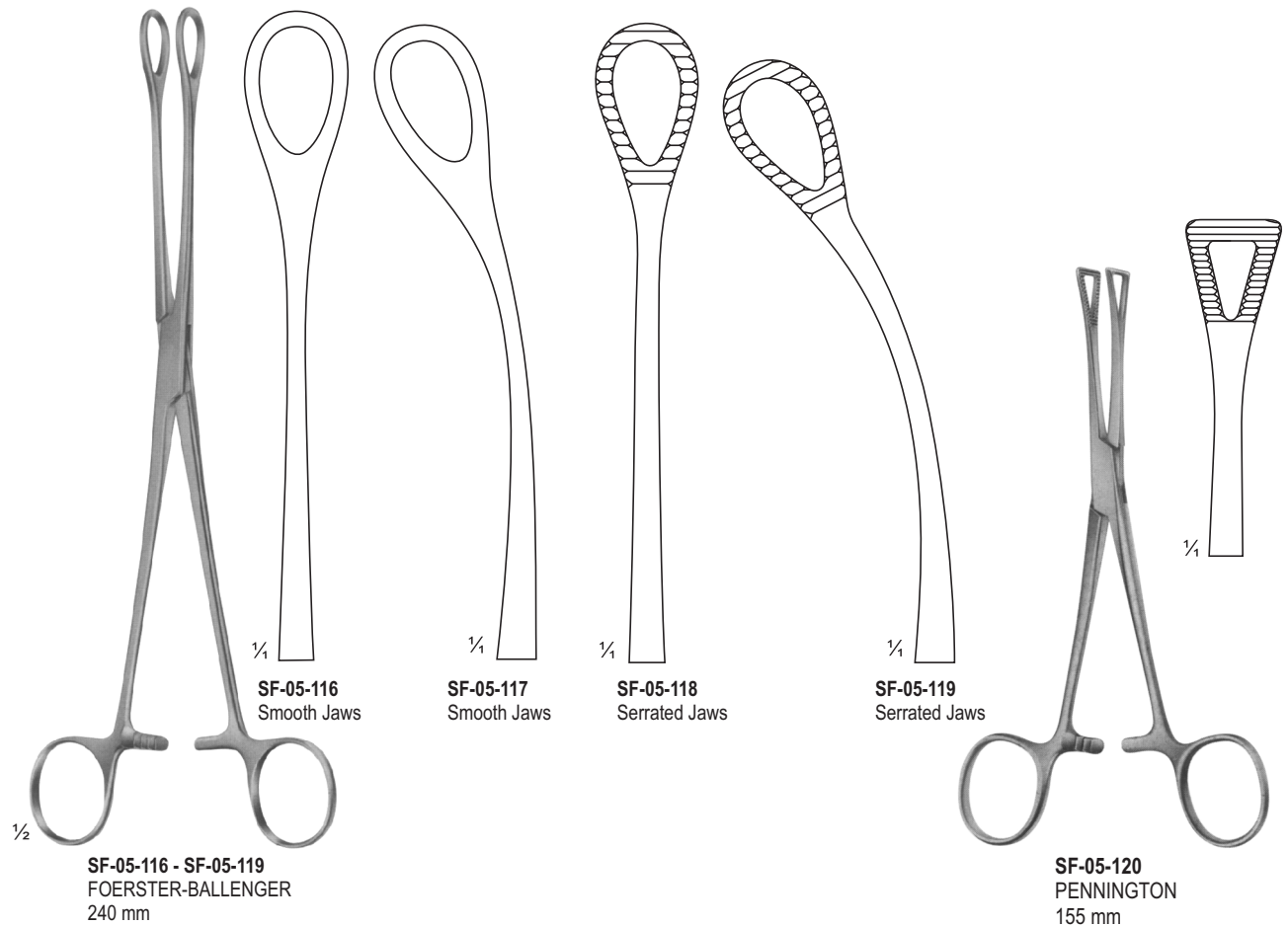
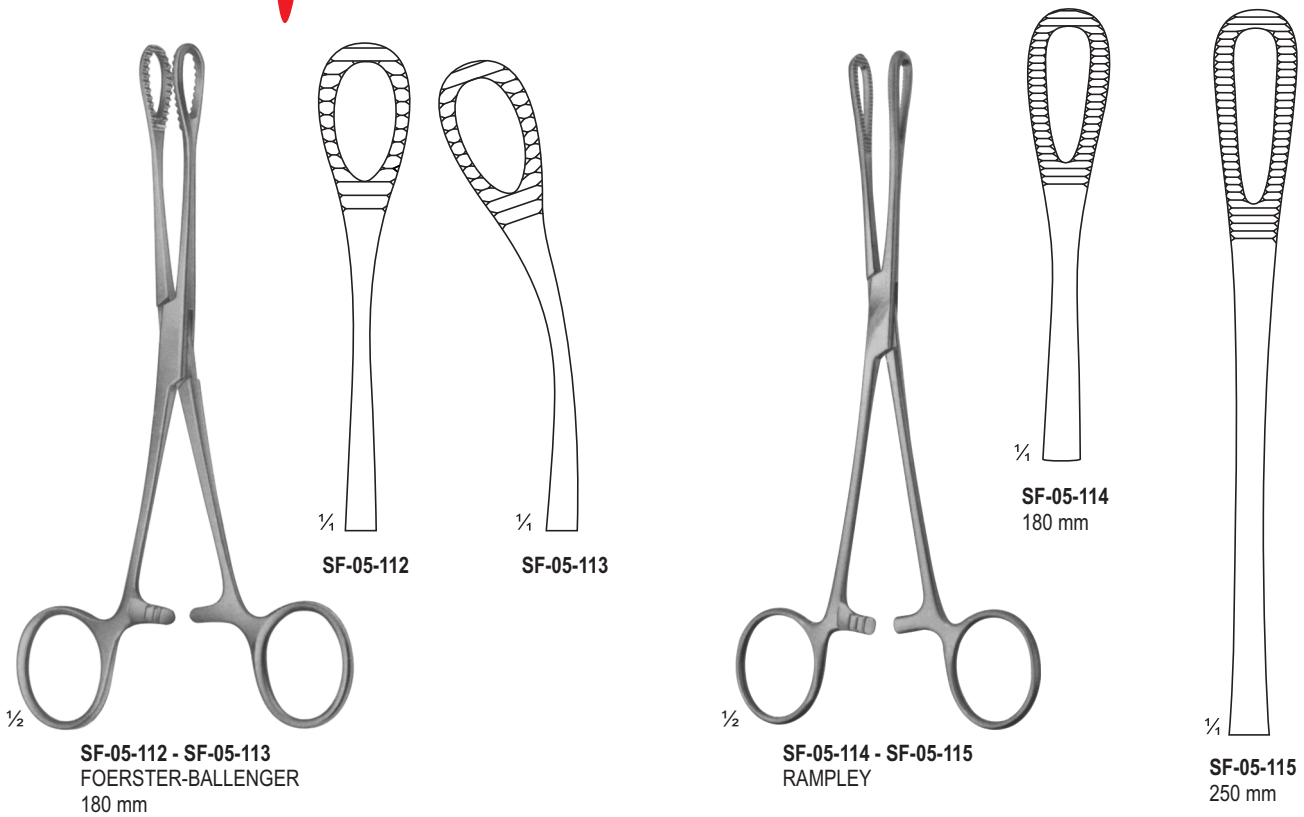

SPONGE AND DRESSING FORCEPS

www.surgiforce.com

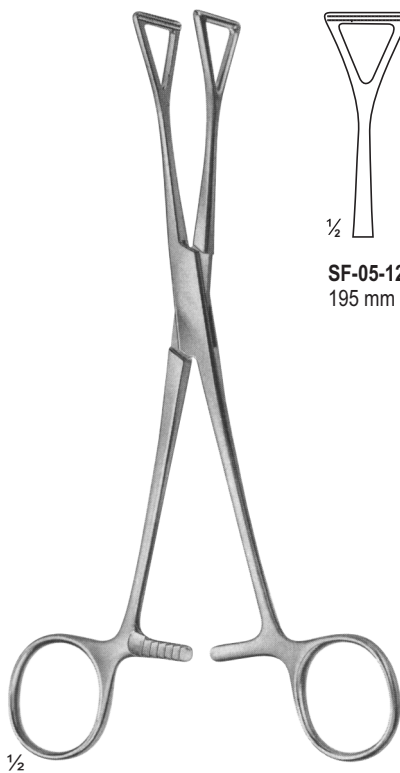

SF-05-121 - SF-05-122
COLLIN



SF-05-121
195 mm

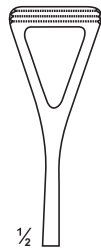

SF-05-122
230 mm



SF-05-123 - SF-05-125
COLLIN

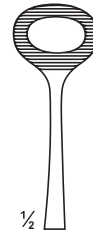

SF-05-123
160 mm



SF-05-124
160 mm

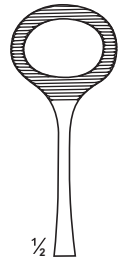

SF-05-125
170 mm

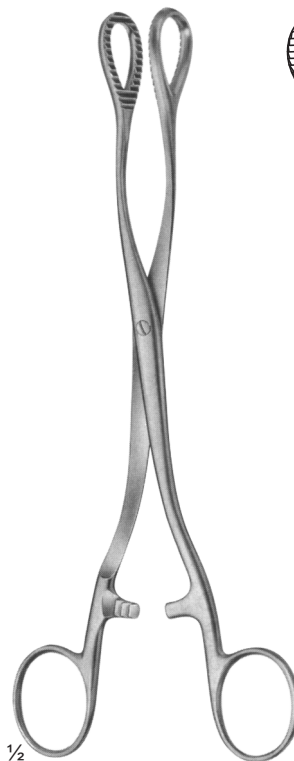

SF-05-126
HEYWOOD-SMITH
200 mm

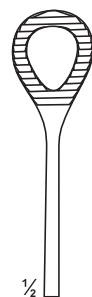

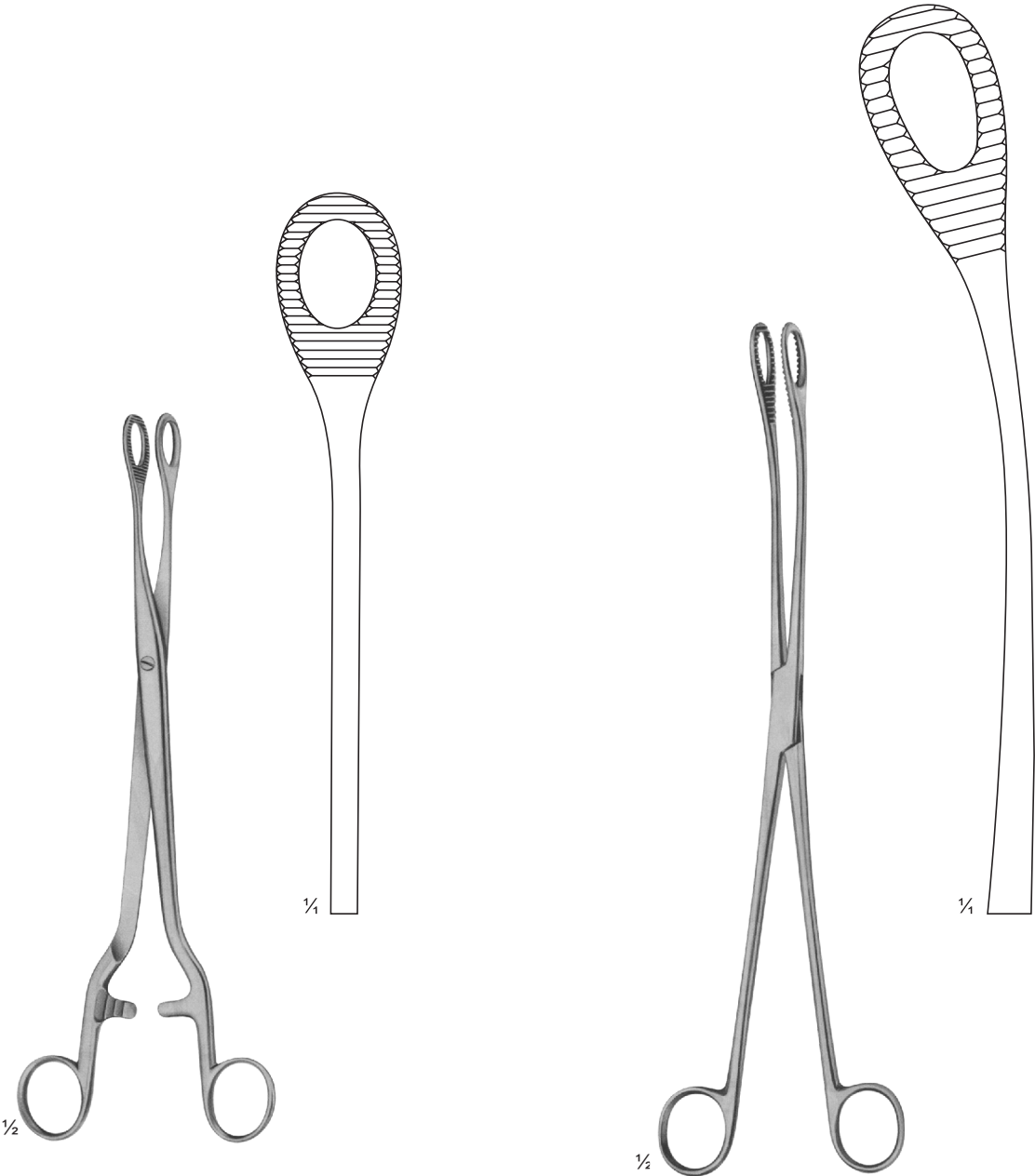

SF-05-127
NOTO
280 mm

SF-05-128
KELLY
320 mm



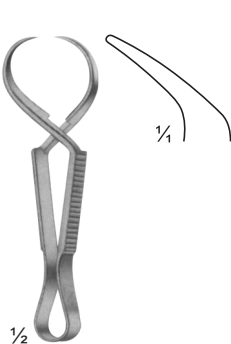

SF-05-133
JONES
85 mm

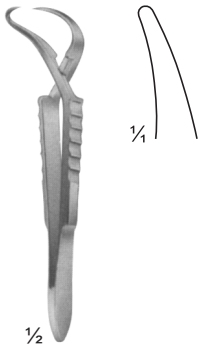

SF-05-134
ENGL. MOD.
85 mm

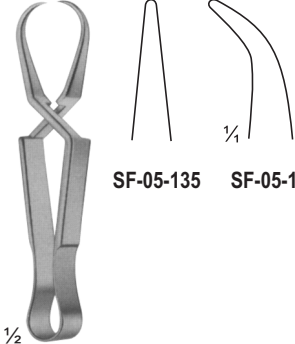

SF-05-135 - SF-05-137
SCHAEDEL
85 mm

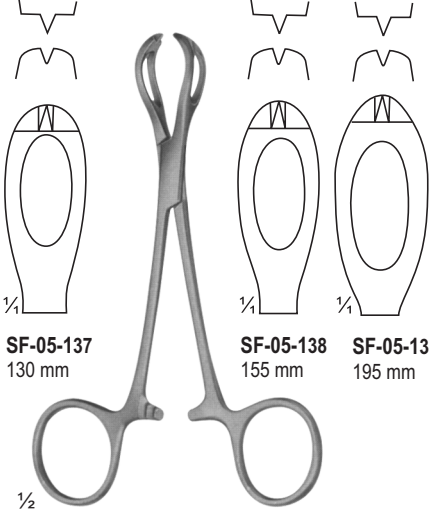

SF-05-138 - SF-05-139
LANE

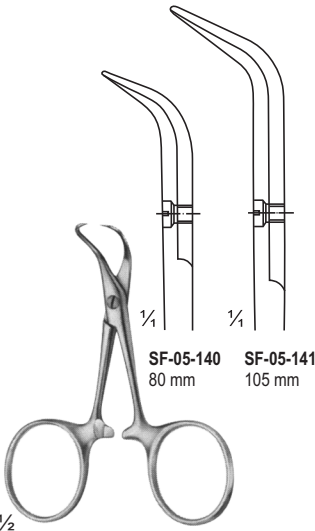

SF-05-140 - SF-05-141
BACKHAUS

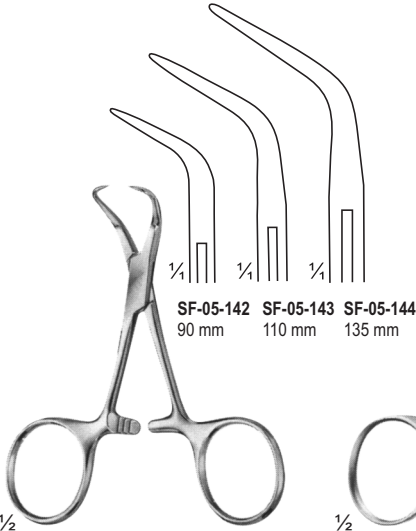

SF-05-142 - SF-05-144
BACKHAUS

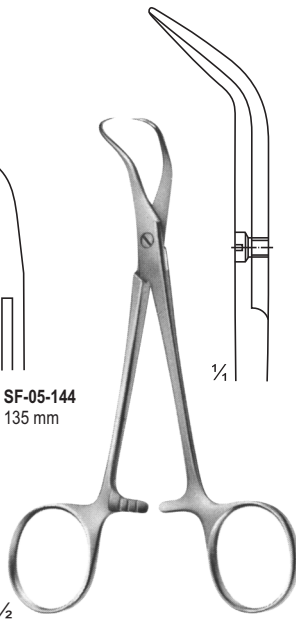

SF-05-145
BACKHAUS-KOCHER
135 mm

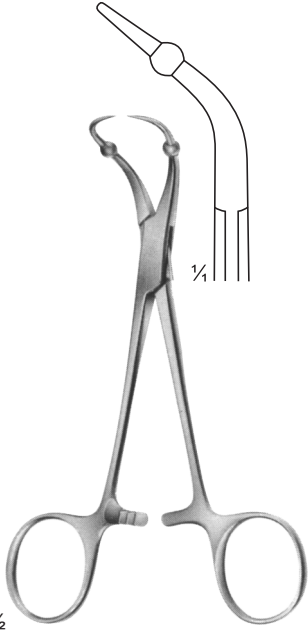

SF-05-146
ROEDER
135 mm

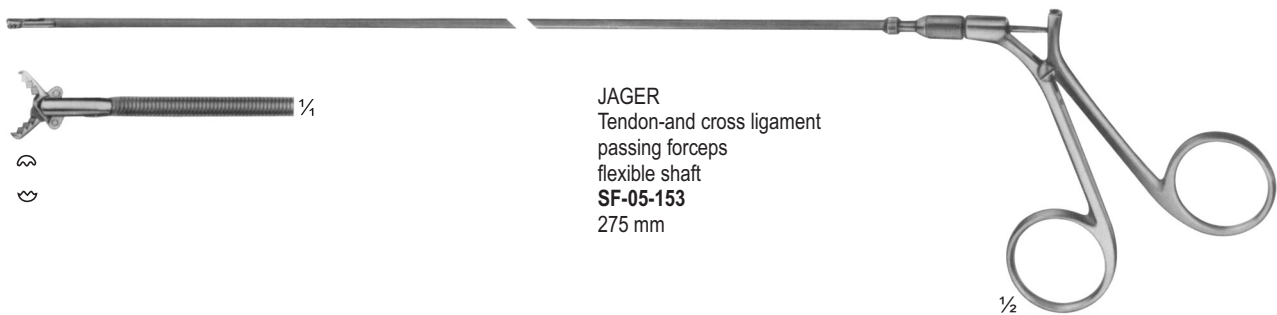
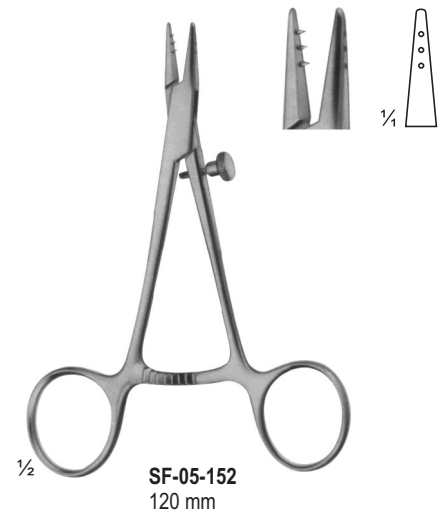
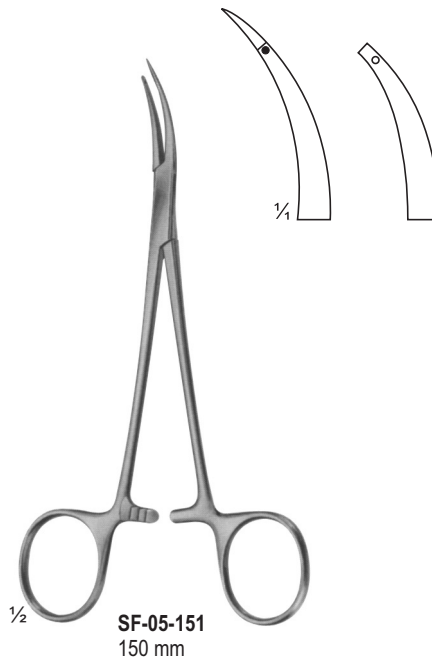
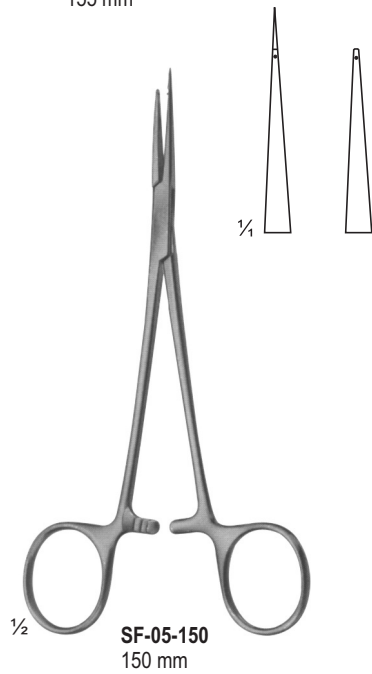
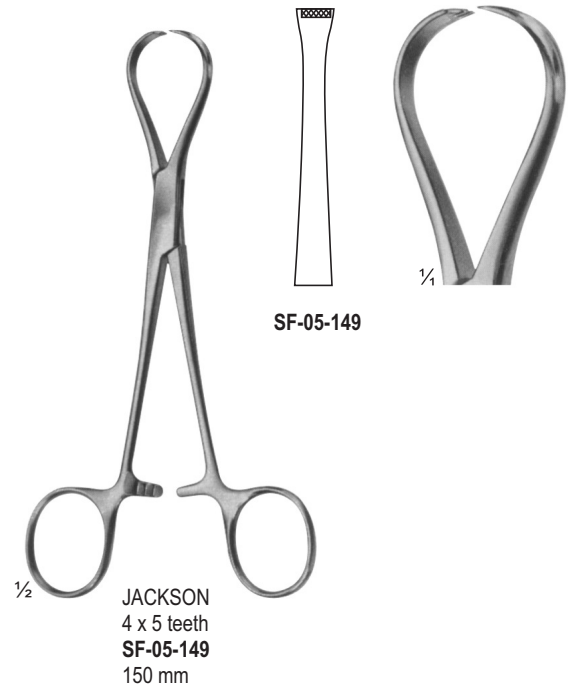
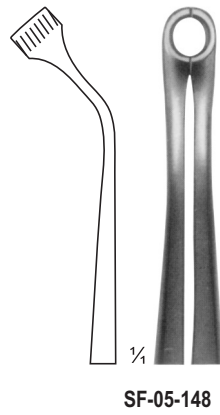
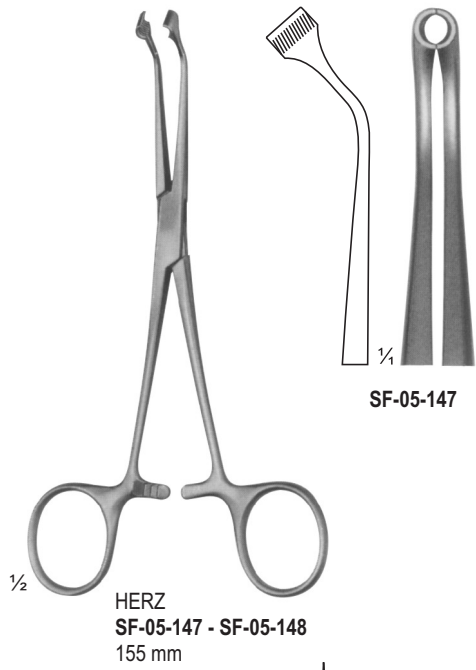

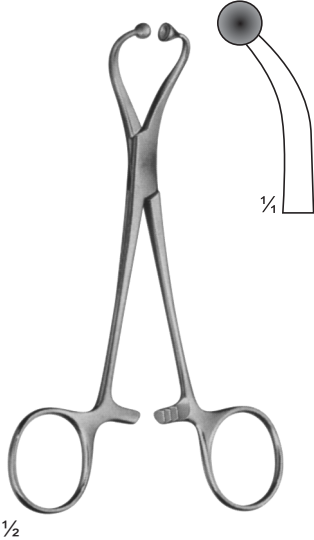

SF-05-154
for paper cloths
140 mm

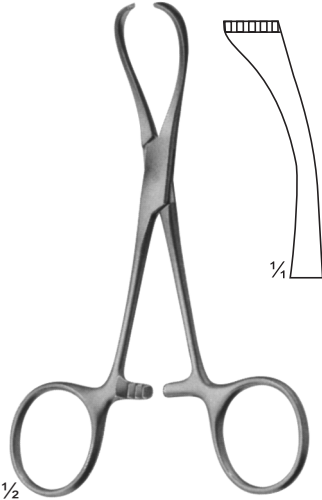

SF-05-155
LORNA
non perforating
130 mm



SF-05-156
BUNT
105 mm



SF-05-157
MAYO
140 mm



Surgiforce Instruments



Opposite Surgical Association,
Malkay Kalan, Marala Road,
Sialkot-51050 Pakistan.



+92 523 559131



info@surgiforce.com
sales@surgiforce.com



www.surgiforce.com



Our Certifications:

ISO 9001

CE Certified

EN 13485:2012

ISO 7153-1

ISO 7151

ISO 17664:2004

ISO 13402

ISO 15223

