

Page  
22–70

- Scissors

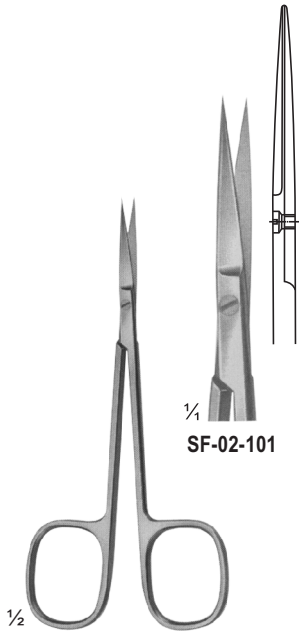

**SF-02-101**

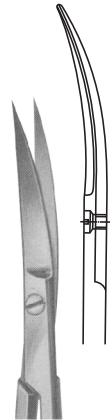

**SF-02-102**

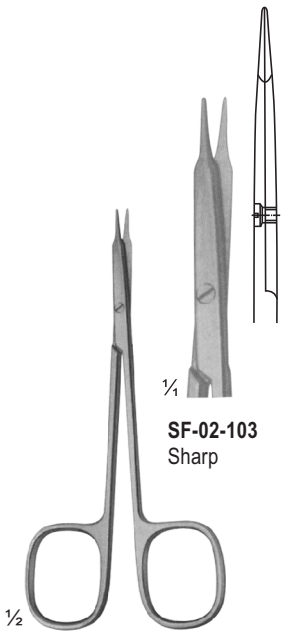

**SF-02-103**  
Sharp

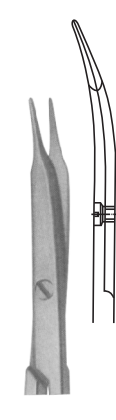

**SF-02-104**  
Sharp

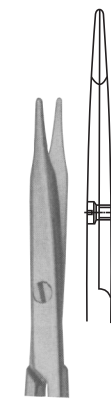

**SF-02-105**  
Blunt

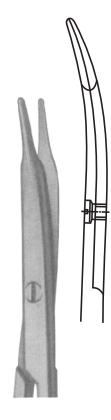

**SF-02-106**  
Blunt

**SF-02-101 - SF-02-102**  
120 mm

**SF-02-103 - SF-02-106**  
STEVENS  
Dissecting Scissors  
115 mm

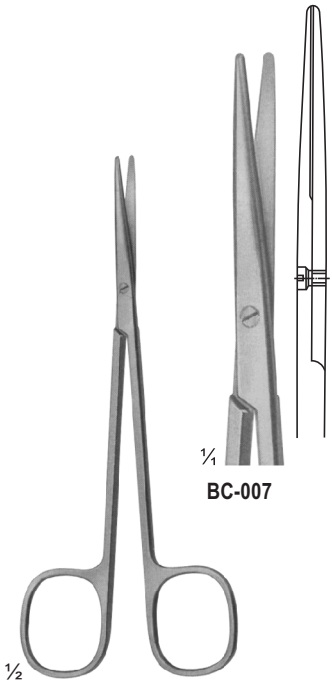

**BC-007**

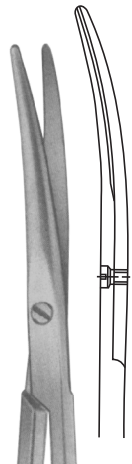

**BC-008**

**SF-02-107 - SF-02-108**  
METZENBAUM  
Dissecting Scissors  
145 mm

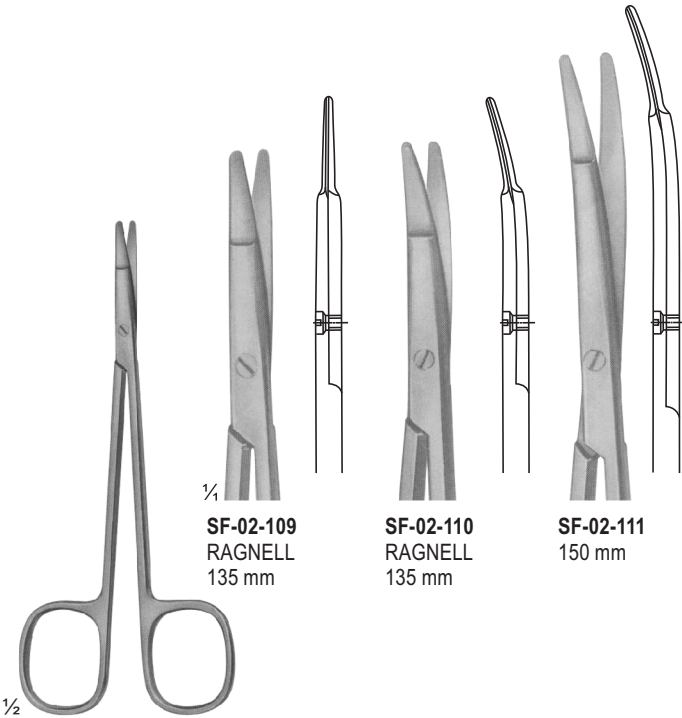

**SF-02-109**  
RAGNELL  
135 mm

**SF-02-110**  
RAGNELL  
135 mm

**SF-02-111**  
150 mm

**SF-02-109 - SF-02-111**  
Special flat points for  
dissecting and  
undermining the skin  
145 mm

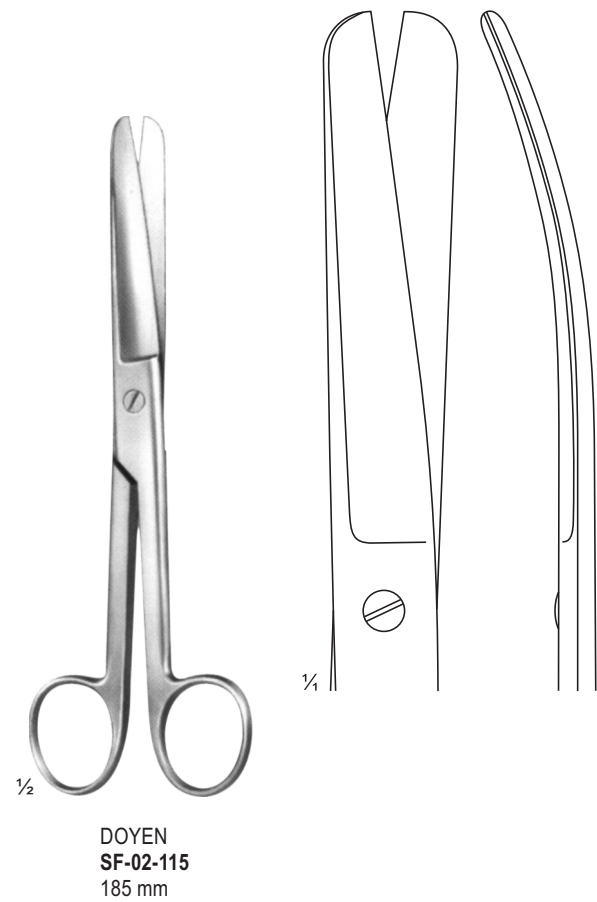
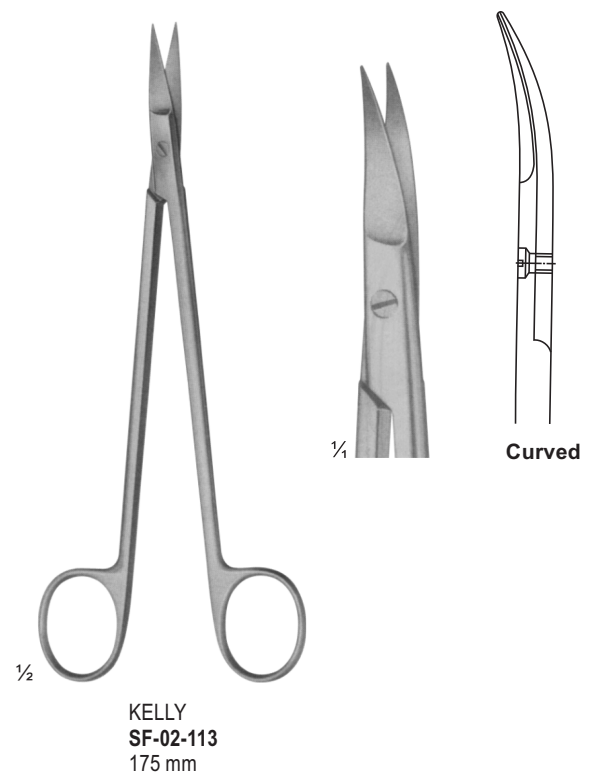
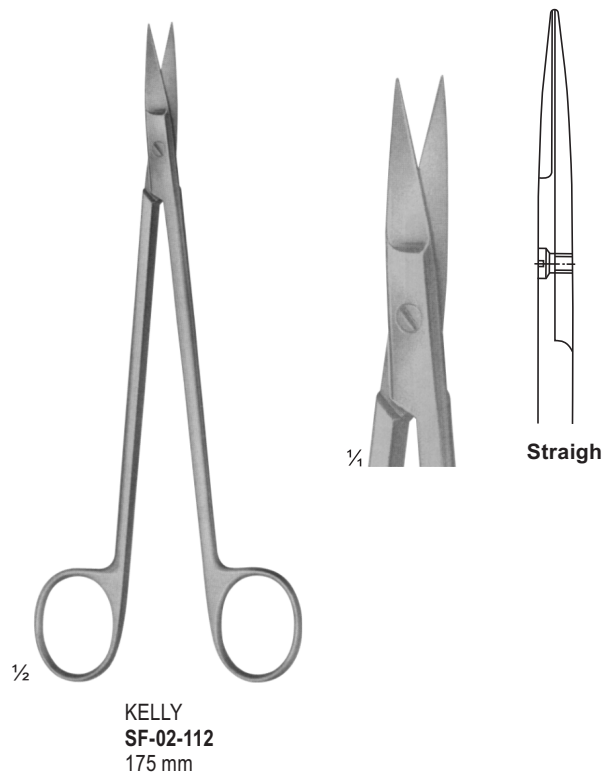

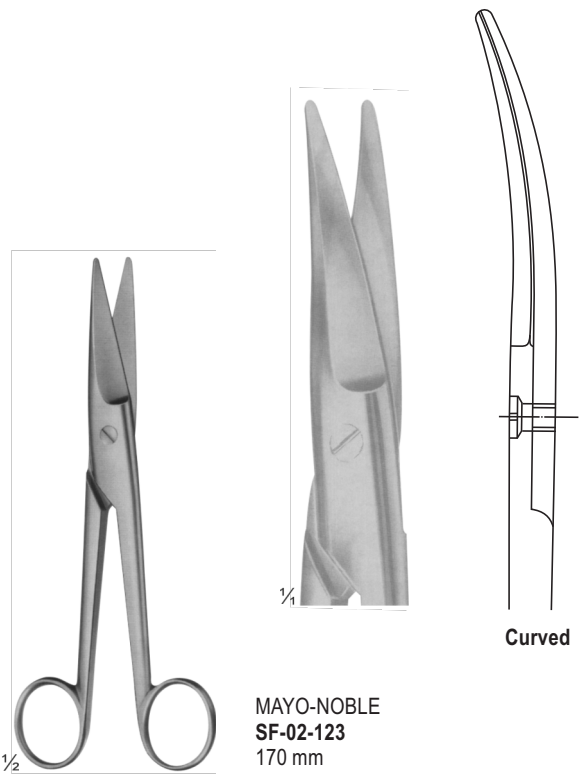
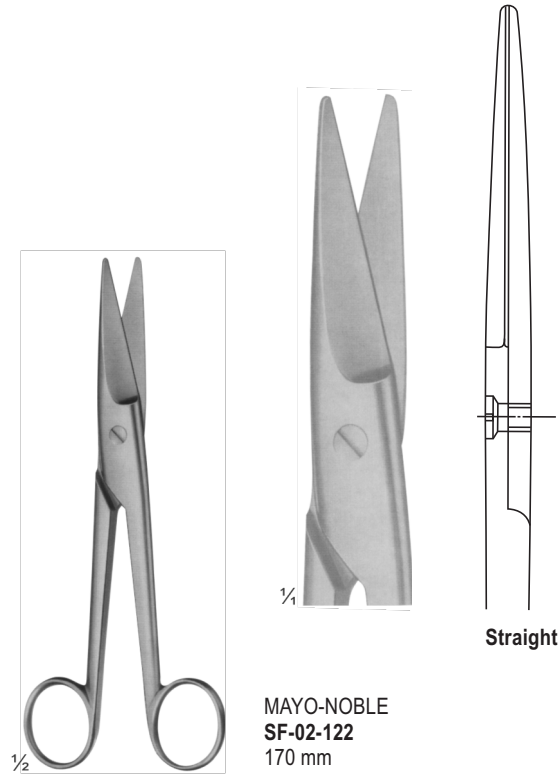
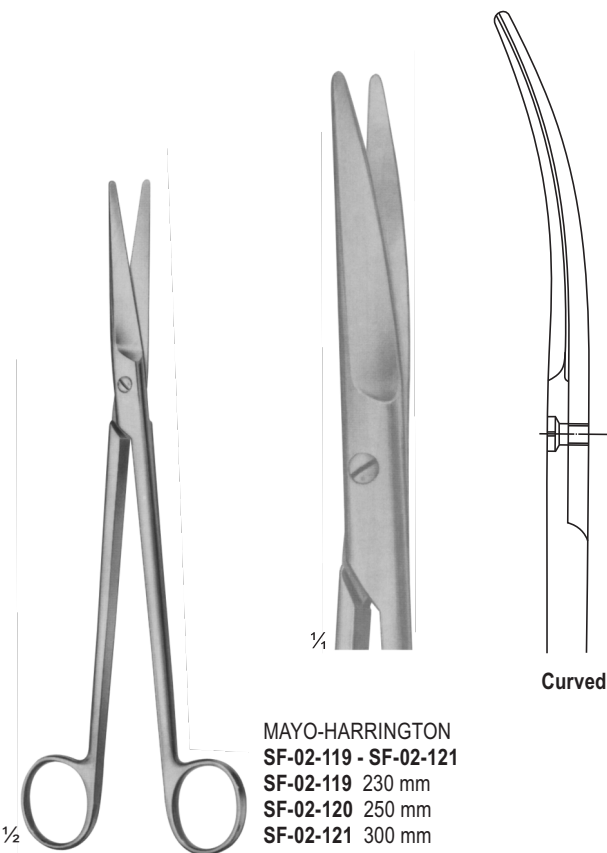
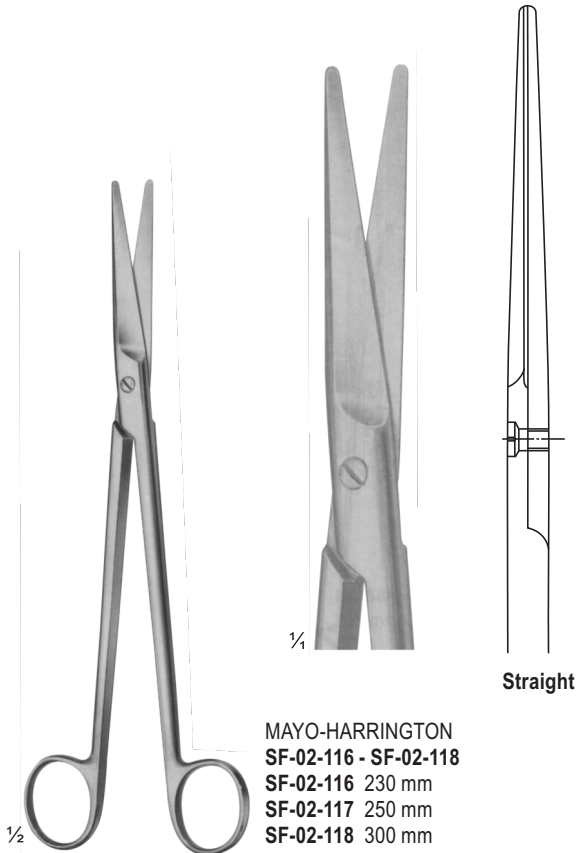

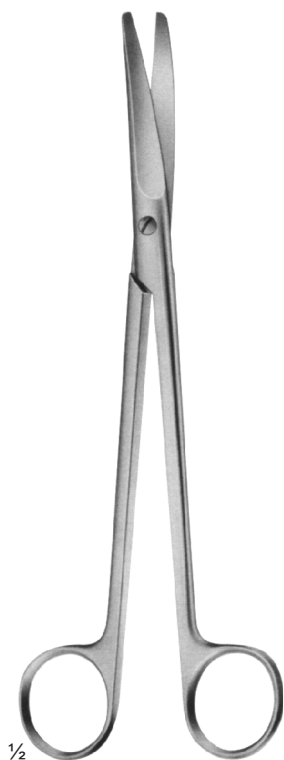

1/2

SIMS  
SF-02-124 - SF-02-126  
SF-02-124 200 mm  
SF-02-125 210 mm  
SF-02-126 230 mm

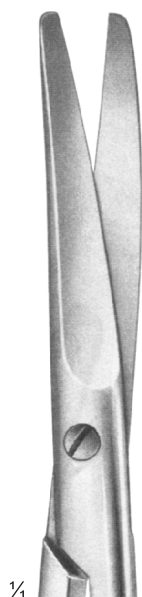

1/4



Curved



1/2

WERTHEIM  
SF-02-127 - SF-02-129  
SF-02-127 145 mm  
SF-02-128 200 mm  
SF-02-129 230 mm

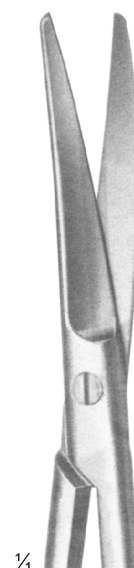

1/4



Curved

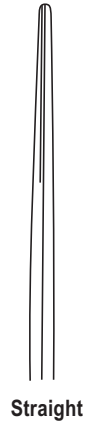
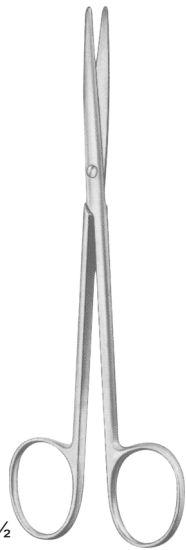

**Straight**

**FINO-METZENBAUM**  
**SF-02-130 - SF-02-135**  
**SF-02-130** 180 mm  
**SF-02-131** 200 mm  
**SF-02-132** 230 mm  
**SF-02-133** 260 mm  
**SF-02-134** 280 mm  
**SF-02-135** 300 mm



**Curved**

**FINO-METZENBAUM**  
**SF-02-136 - SF-02-141**  
**SF-02-136** 180 mm  
**SF-02-137** 200 mm  
**SF-02-138** 230 mm  
**SF-02-139** 260 mm  
**SF-02-140** 280 mm  
**SF-02-141** 300 mm

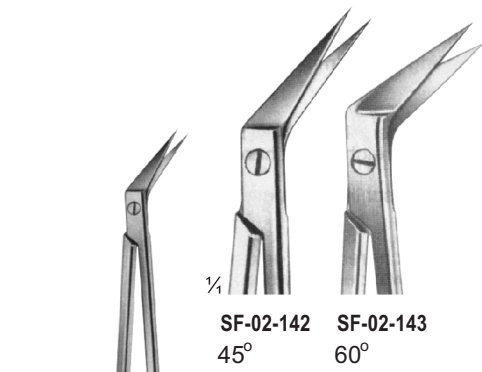

$\frac{1}{2}$   
**SF-02-142 - SF-02-143**  
DE BAKEY  
155 mm

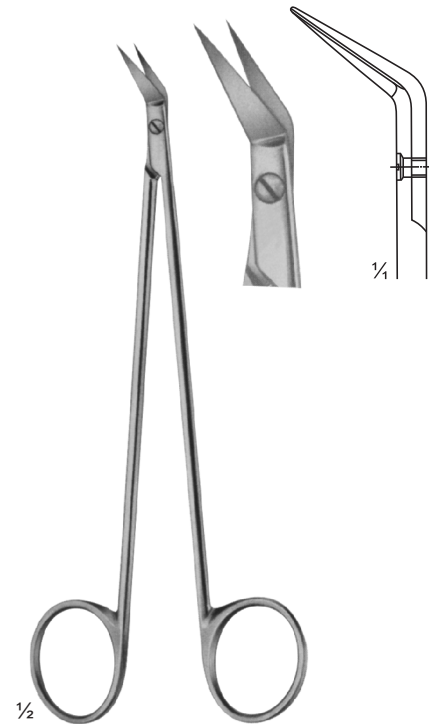

$\frac{1}{2}$   
**SF-02-144**  
POTTS-SMITH  
180 mm

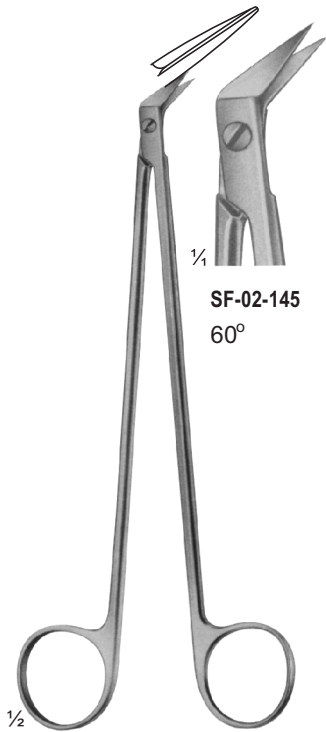

$\frac{1}{2}$   
**SF-02-145**  
POTTS-SMITH  
180 mm

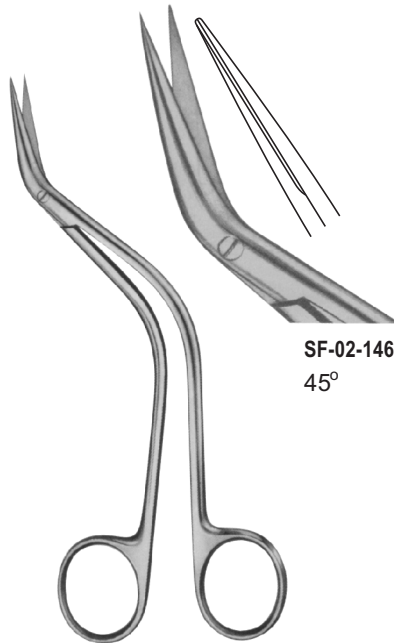

**SF-02-146**  
DEBAKEY  
155 mm

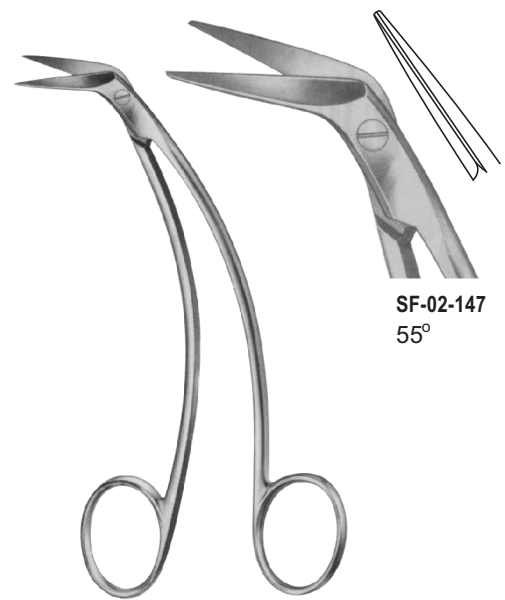

**SF-02-147**  
FAVOLORO  
140 mm

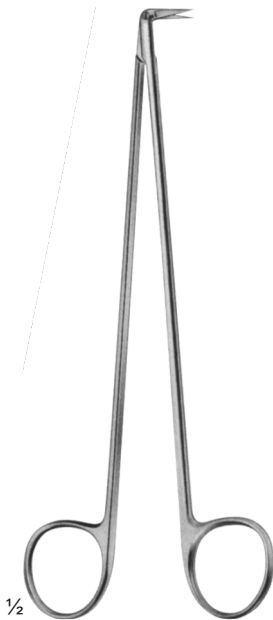

DIETHRICH  
SF-02-148 - SF-02-152

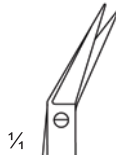

SF-02-148  
190 mm  
25°



SF-02-149  
185 mm  
45°

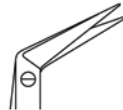

SF-02-150  
175 mm  
60°



SF-02-151  
175 mm  
90°



SF-02-152  
175 mm  
120°

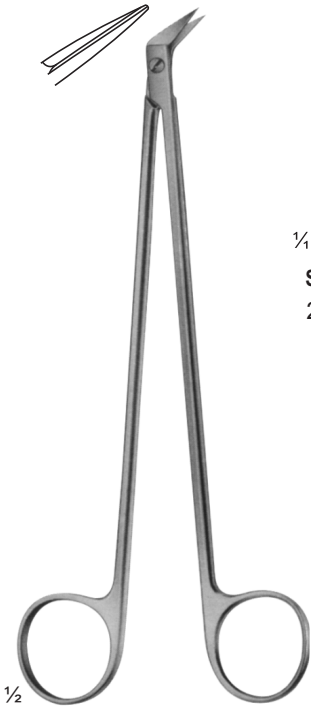

MIKRO-HEGEMANN  
SF-02-153 - SF-02-157  
185 mm



SF-02-153  
25°



SF-02-154  
45°

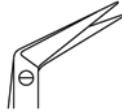

SF-02-155  
60°



SF-02-156  
90°



SF-02-157  
120°



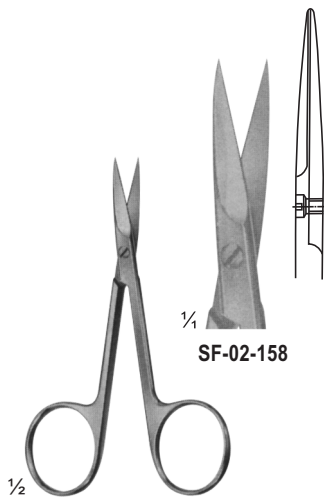

SF-02-158

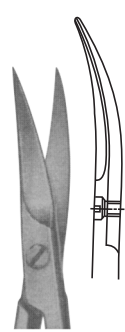

SF-02-159

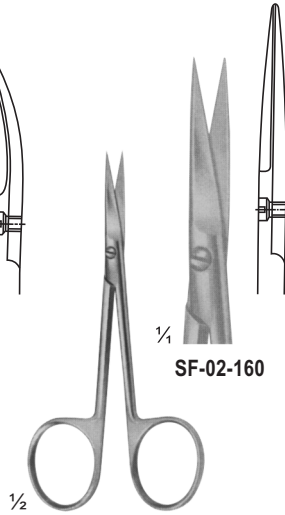

SF-02-160

SF-02-160 - SF-02-161  
95 mm

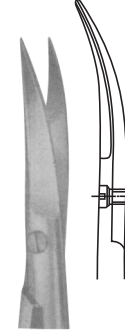

SF-02-161

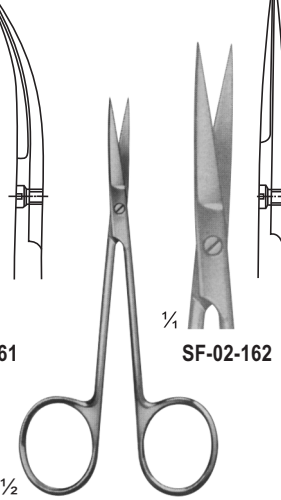

SF-02-162

SF-02-162 - SF-02-163  
Iris  
100 mm

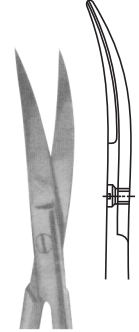

SF-02-163

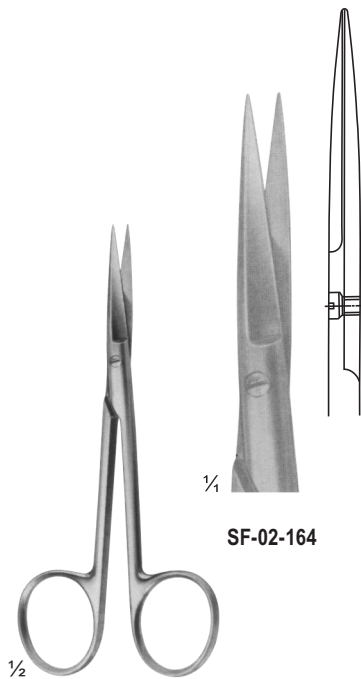

SF-02-164

SF-02-164 - SF-02-165  
Wagner  
130 mm

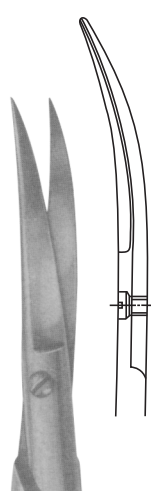

SF-02-165

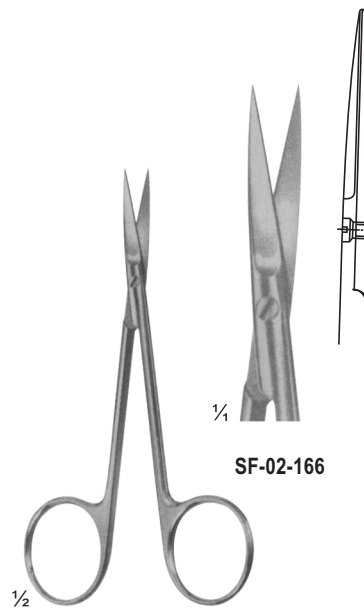

SF-02-166

SF-02-166 - SF-02-167  
Iris  
110 mm

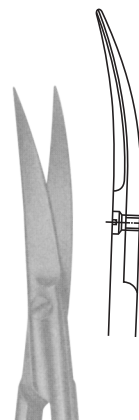

SF-02-167



**SF-02-168 - SF-02-170**  
Fine Operating Scissors  
120 mm

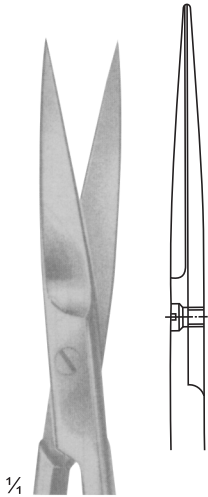

**SF-02-168**

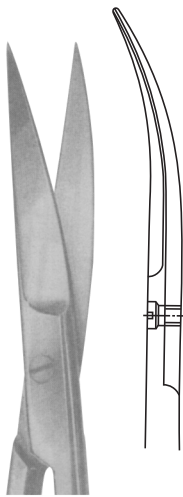

**SF-02-169**

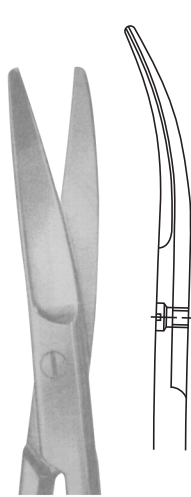

**SF-02-170**



**SF-02-171 - SF-02-174**  
Fine Operating Scissors  
130 mm

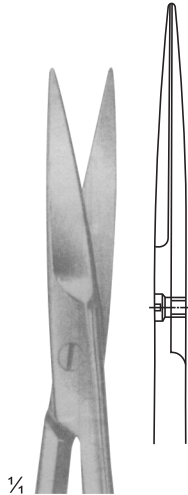

**SF-02-171**

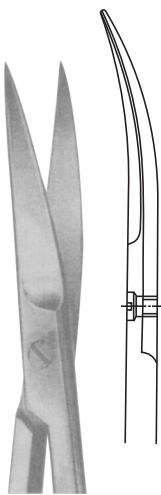

**SF-02-172**

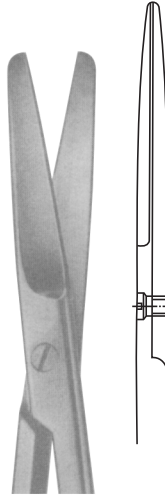

**SF-02-173**

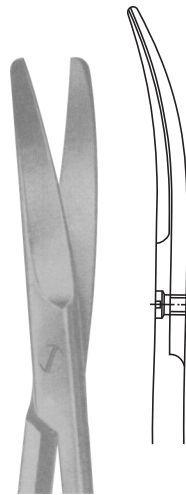

**SF-02-174**

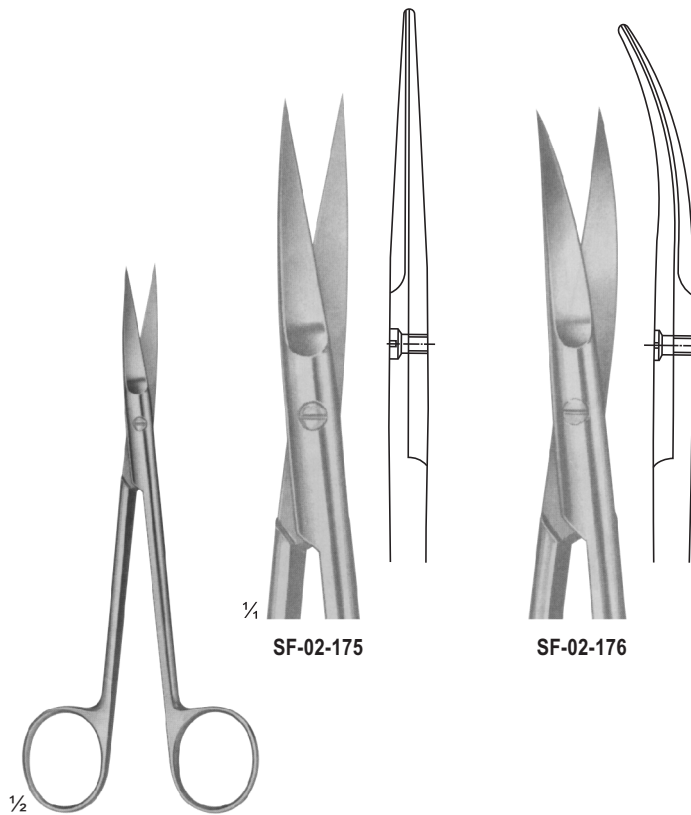

**SF-02-175 - SF-02-176**  
JOSEPH  
150 mm

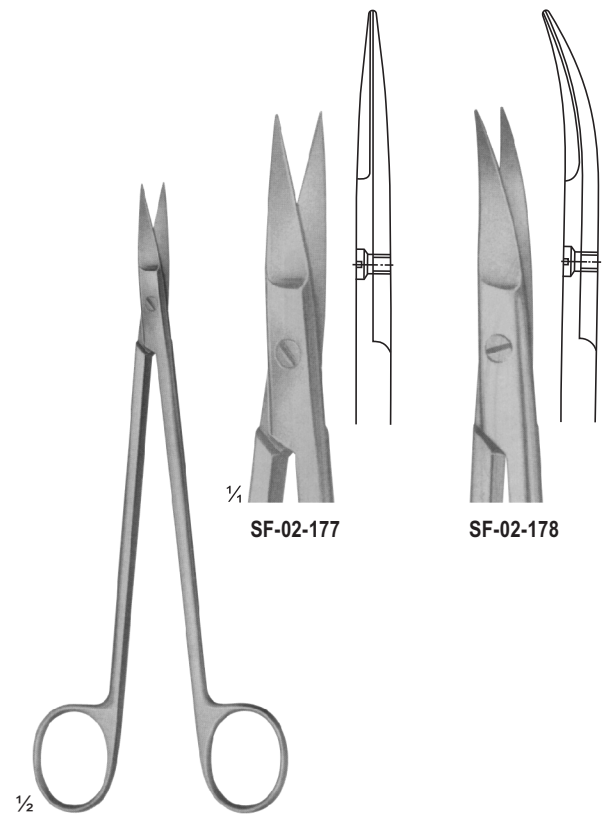

**SF-02-177 - SF-02-178**  
KELLY  
175 mm

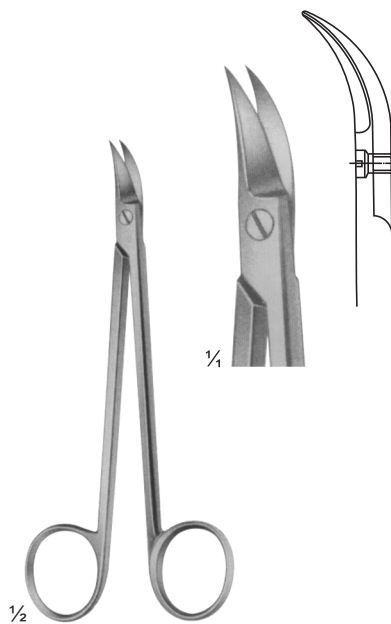

**SF-02-179**  
QUINBY  
130 mm

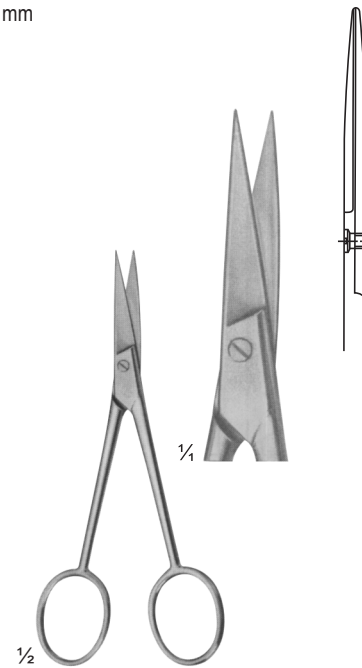

**SF-02-180**  
Dissecting  
110 mm

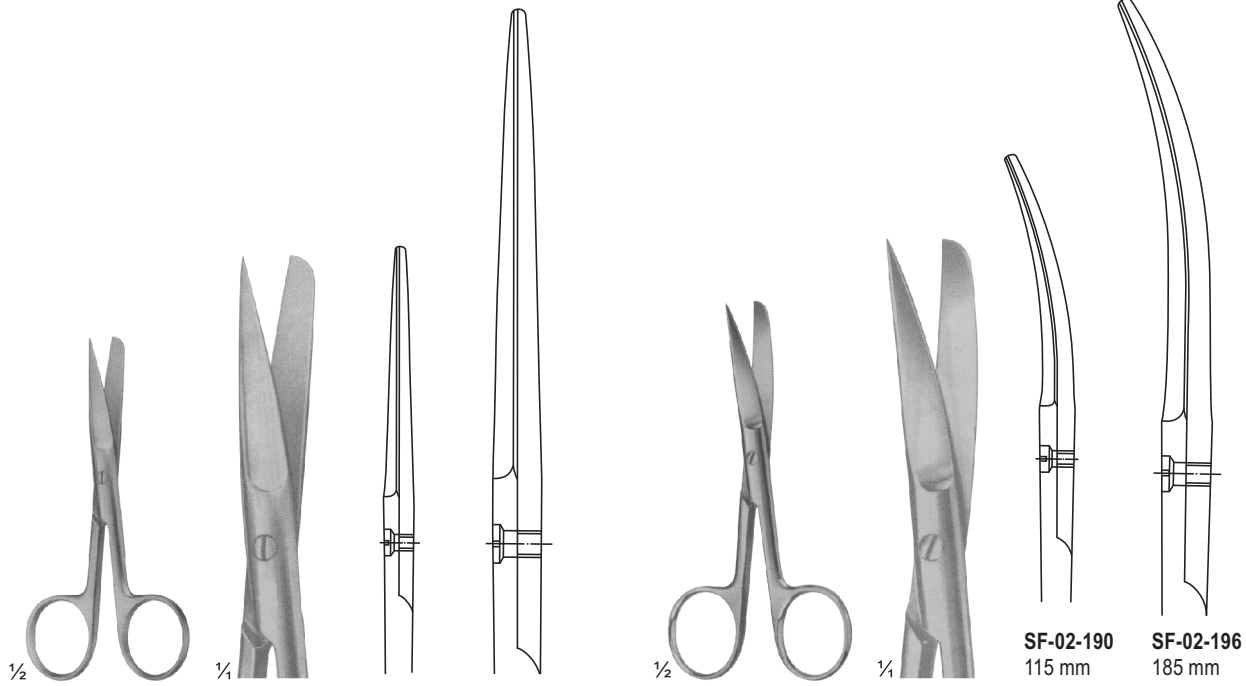

**SF-02-181 - SF-02-189** (Standard Types)  
**SF-02-181** (105 mm)  
**SF-02-182** (115 mm)  
**SF-02-183** (130 mm)  
**SF-02-184** (145 mm)  
**SF-02-185** (150 mm)  
**SF-02-186** (165 mm)  
**SF-02-187** (175 mm)  
**SF-02-188** (185 mm)  
**SF-02-189** (200 mm)

**SF-02-181** 105 mm  
**SF-02-189** 200 mm

**SF-02-190 - SF-02-195** (Standard Types)  
**SF-02-190** (115 mm)  
**SF-02-191** (130 mm)  
**SF-02-192** (145 mm)  
**SF-02-193** (150 mm)  
**SF-02-194** (165 mm)  
**SF-02-195** (175 mm)  
**SF-02-196** (185 mm)

**SF-02-190** 115 mm  
**SF-02-196** 185 mm

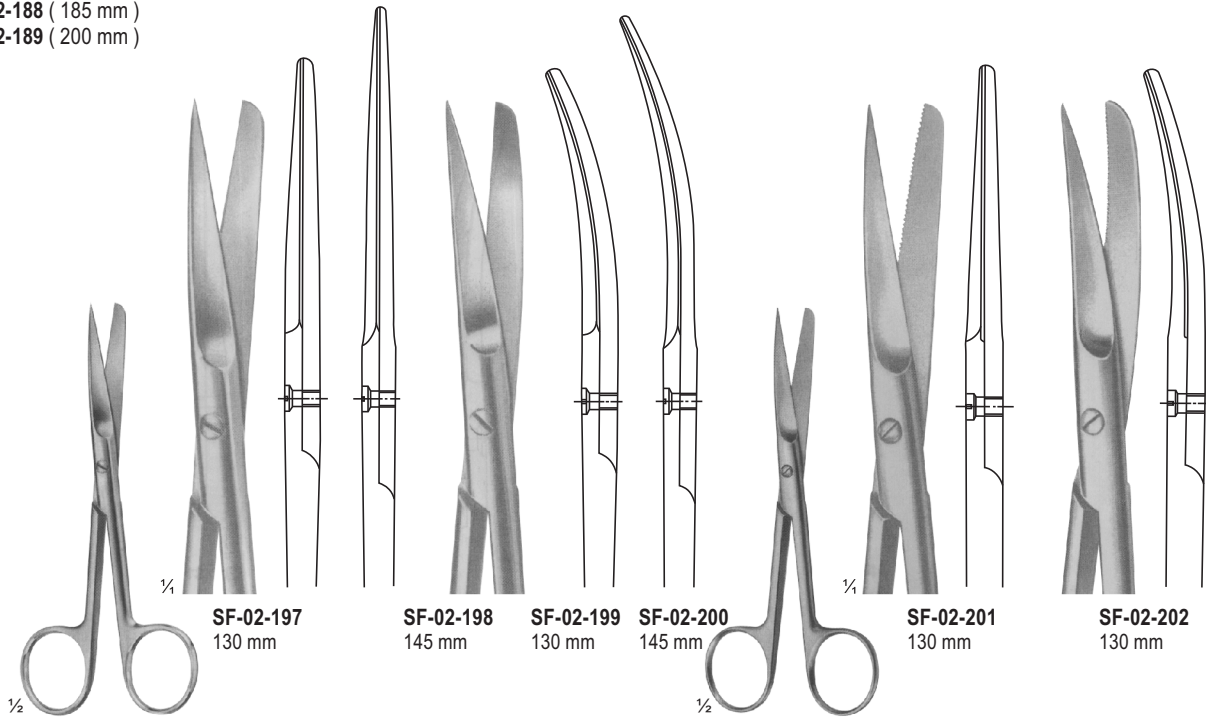

**SF-02-197 - SF-02-200**  
Slender Types

**SF-02-197** 130 mm

**SF-02-198** 145 mm

**SF-02-199** 130 mm

**SF-02-200** 145 mm

**SF-02-201** 130 mm

**SF-02-202** 130 mm

**SF-02-201 - SF-02-202**  
For Wound Edges  
1 Blade Serrated

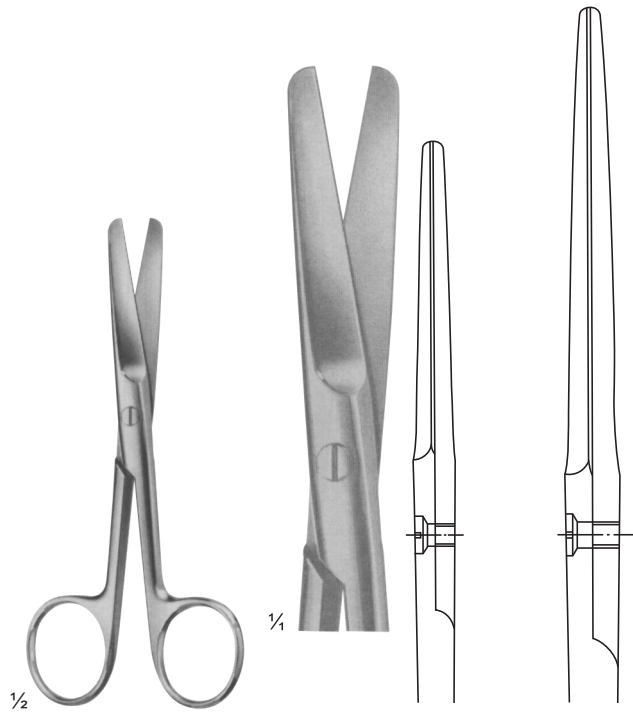

**SF-02-203 - SF-02-207** (Standard Types)  
**SF-02-203** ( 130 mm )  
**SF-02-204** ( 145 mm )  
**SF-02-205** ( 150 mm )  
**SF-02-206** ( 165 mm )  
**SF-02-207** ( 175 mm )

**SF-02-203**  
 130 mm

**SF-02-207**  
 175 mm

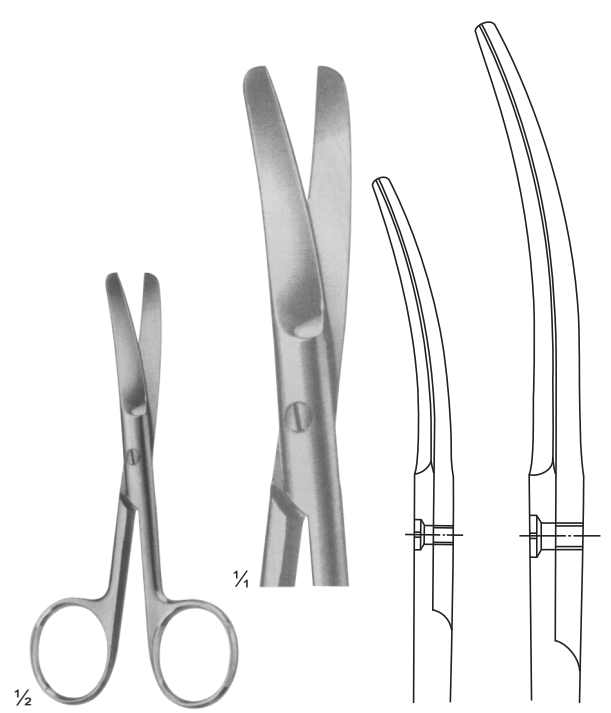

**SF-02-208 - SF-02-213** - COOPER  
 Standard Types  
**SF-02-208** ( 115 mm )  
**SF-02-209** ( 130 mm )  
**SF-02-210** ( 145 mm )  
**SF-02-211** ( 150 mm )  
**SF-02-212** ( 165 mm )  
**SF-02-213** ( 175 mm )

**SF-02-208**  
 115 mm

**SF-02-213**  
 175 mm



**SF-02-214 - SF-02-218**  
 Standard Types  
**SF-02-214** ( 115 mm )  
**SF-02-215** ( 130 mm )  
**SF-02-216** ( 145 mm )  
**SF-02-217** ( 150 mm )  
**SF-02-218** ( 165 mm )

**SF-02-214**  
 115 mm

**SF-02-218**  
 165 mm

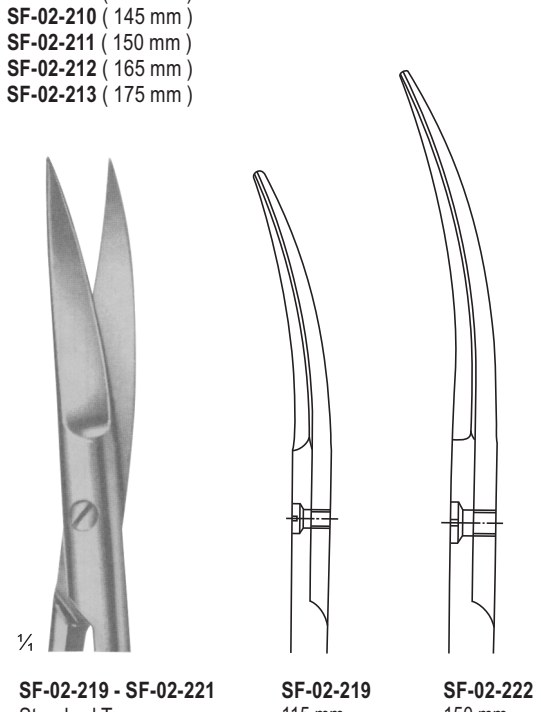

**SF-02-219 - SF-02-221**  
 Standard Types  
**SF-02-219** ( 115 mm )  
**SF-02-220** ( 130 mm )  
**SF-02-221** ( 145 mm )  
**SF-02-222** ( 150 mm )

**SF-02-219**  
 115 mm

**SF-02-222**  
 150 mm

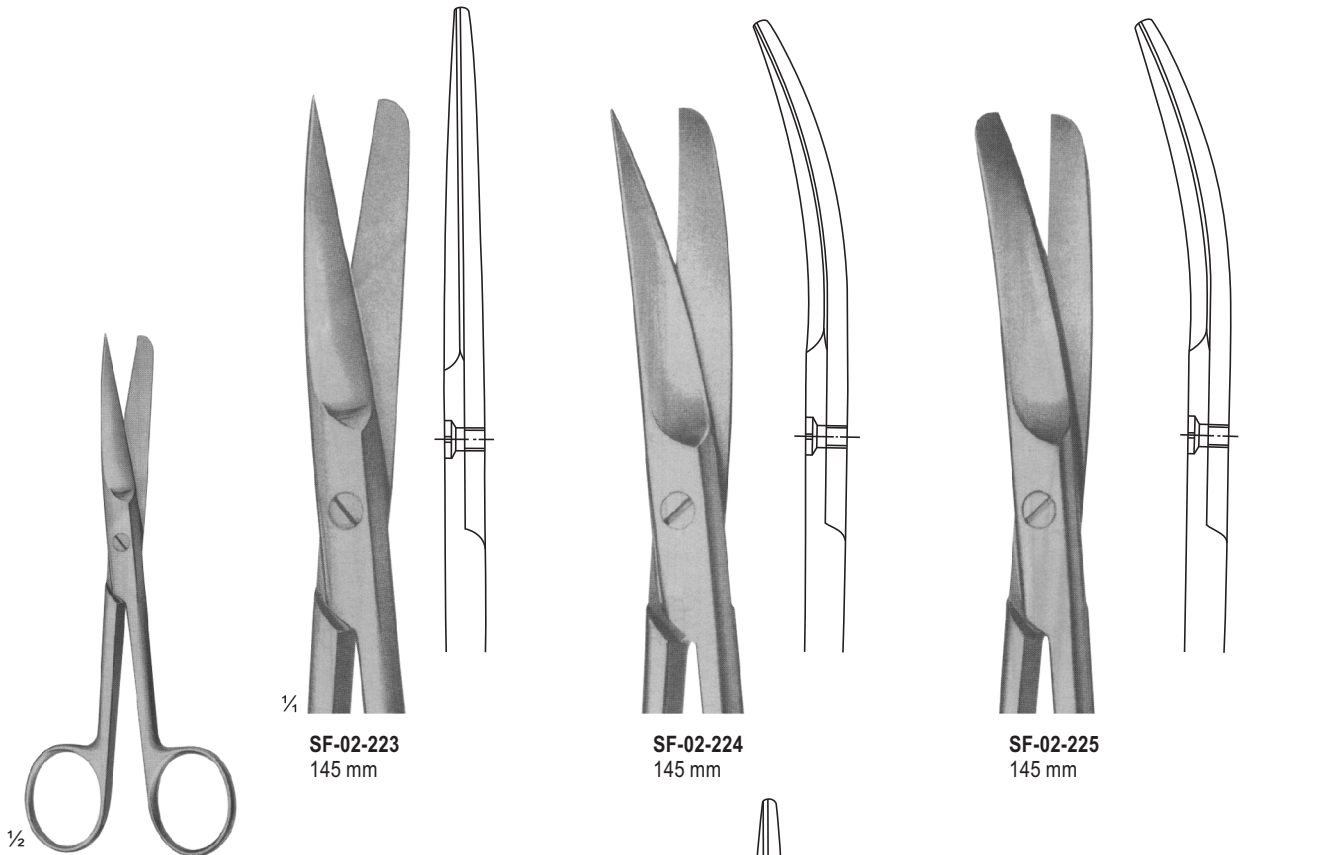

**SF-02-223**  
145 mm

**SF-02-224**  
145 mm

**SF-02-225**  
145 mm

**SF-02-223 - SF-02-225**  
DEAVER  
With flat lock

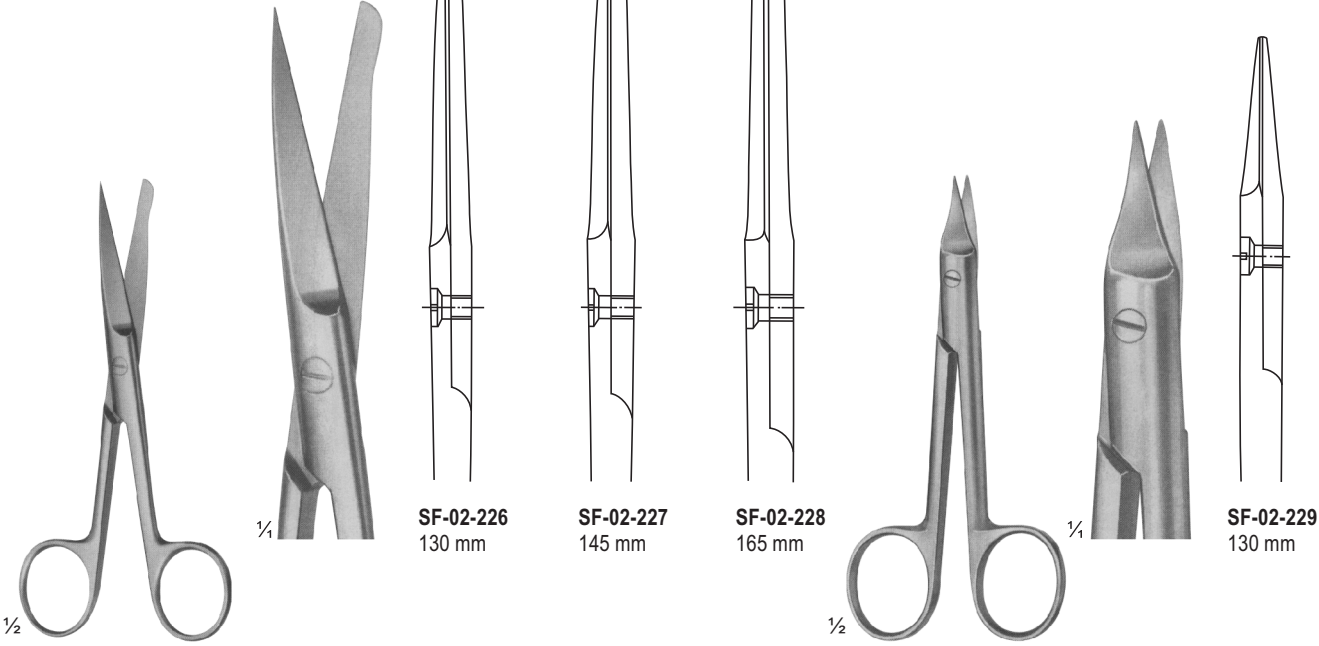

**SF-02-226**  
130 mm

**SF-02-227**  
145 mm

**SF-02-228**  
165 mm

**SF-02-229**  
130 mm

**SF-02-226 - SF-02-228**  
Incision Scissors

**SF-02-229**  
SYSTRUNK  
Nail Splitting Scissors

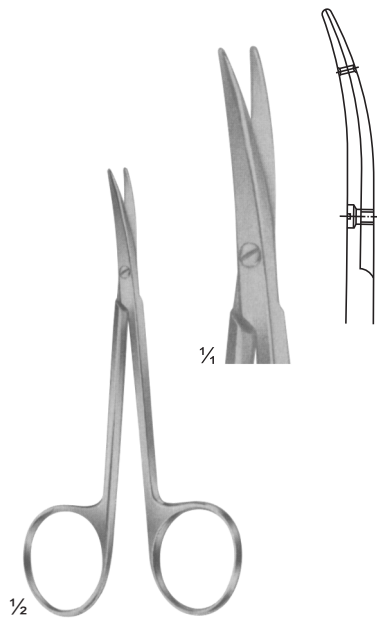

**SF-02-230**  
LITTLER  
Dissecting Scissors  
Tips with eye for suture  
115 mm

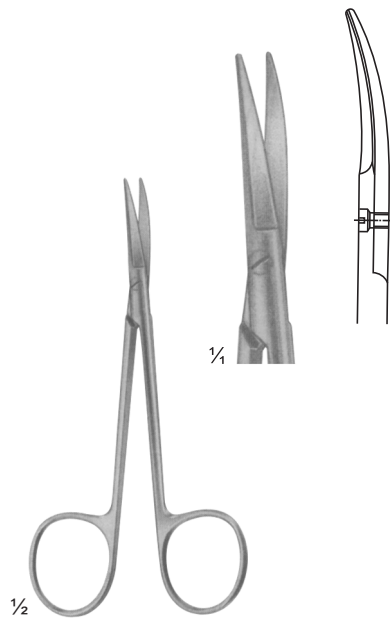

**SF-02-231**  
COTTLE  
Bulldog Scissors  
115 mm

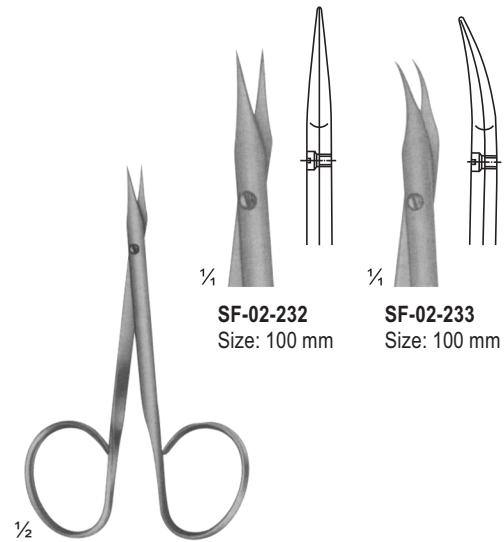

**SF-02-232**  
Size: 100 mm

**SF-02-233**  
Size: 100 mm

**SF-02-232 - SF-02-233**  
STEVENS  
Vessel and tendon Scissors  
100 mm

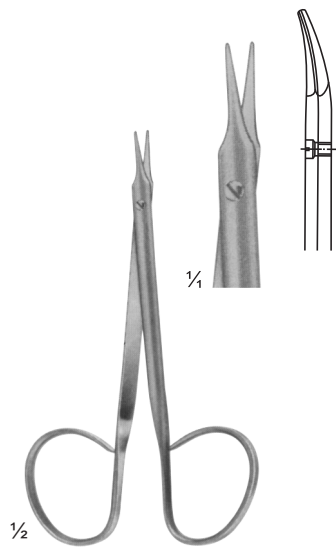

**SF-02-234**  
STEVENS  
Fine Dissecting Scissors  
110 mm

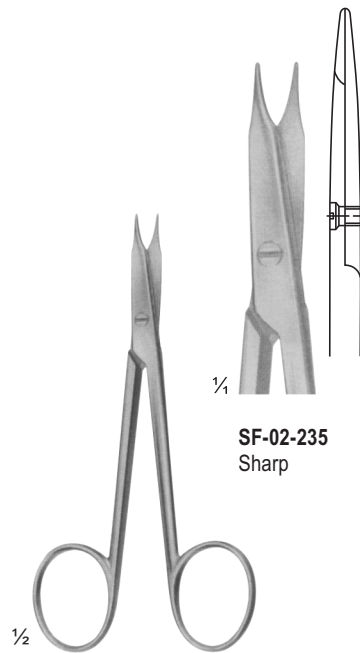

**SF-02-235 - SF-02-238**  
STEVENS  
Vessel and tendon Scissors  
110 mm

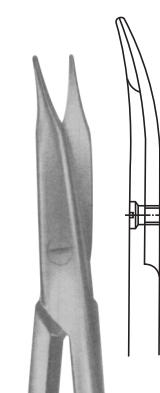

**SF-02-236**  
Sharp

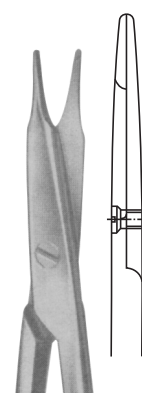

**SF-02-237**  
Blunt

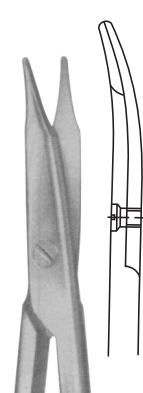

**SF-02-238**  
Blunt

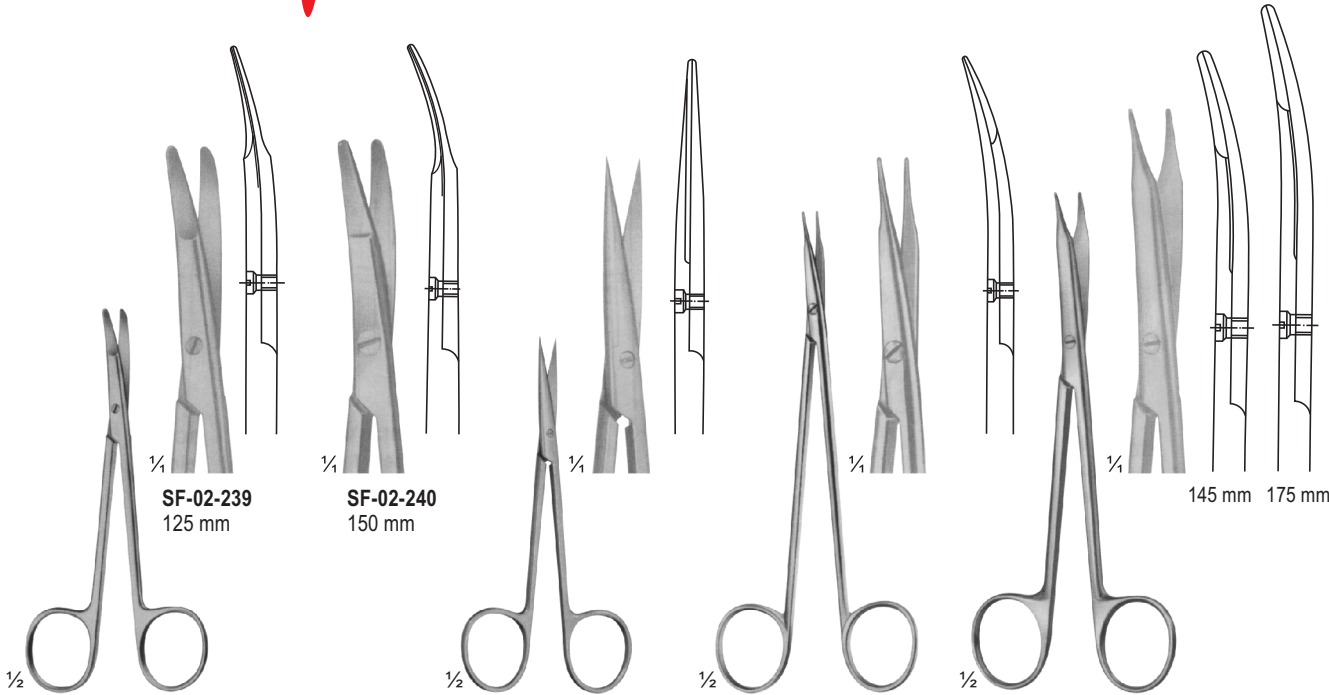

**SF-02-239 - SF-02-240**  
KILNER  
Special flat points for dissecting and undermining the skin

**SF-02-241**  
KILNER  
Fine dissecting scissors  
115 mm

**SF-02-242**  
JAMESON  
Dissecting scissors  
150 mm

**SF-02-243**  
REYNOLDS  
Dissecting scissors  
145 - 175 mm

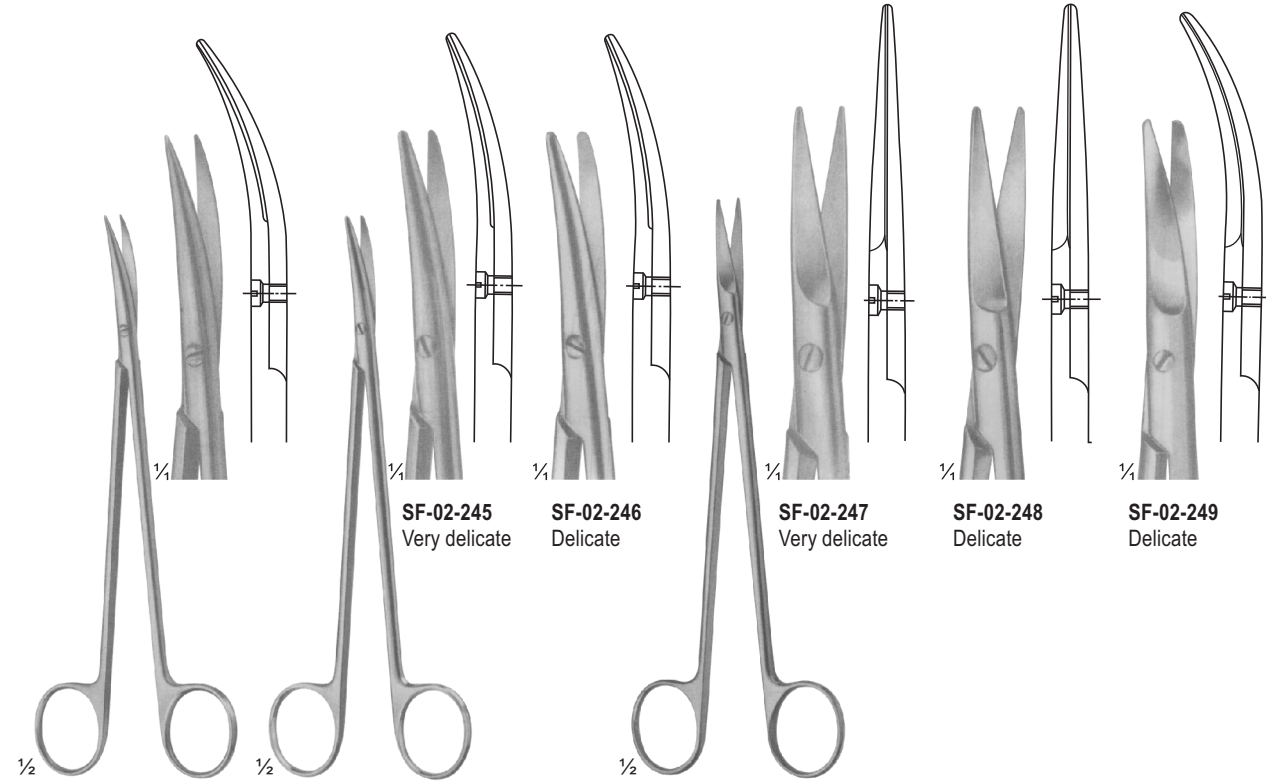

**SF-02-244**  
DE BAKEY  
Ateriectomy scissors  
175 mm

**SF-02-245 - SF-02-246**  
TOENNIS ADSON  
Dissecting scissors  
175 mm

**SF-02-247 - SF-02-249**  
TOENNIS  
Dissecting scissors  
150 mm



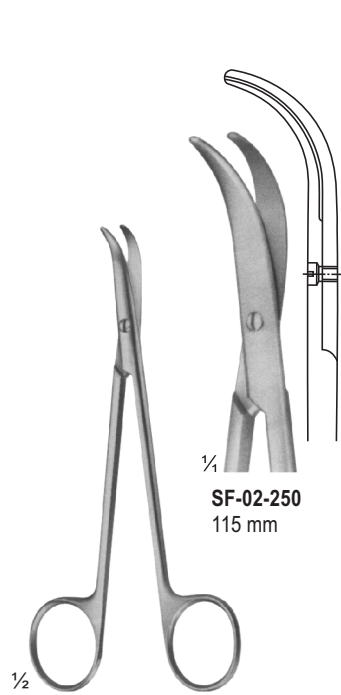

**SF-02-250**  
115 mm

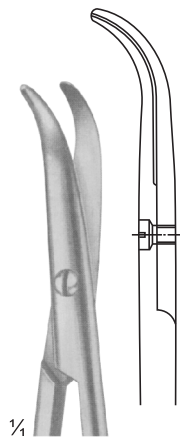

**SF-02-251**  
135 mm

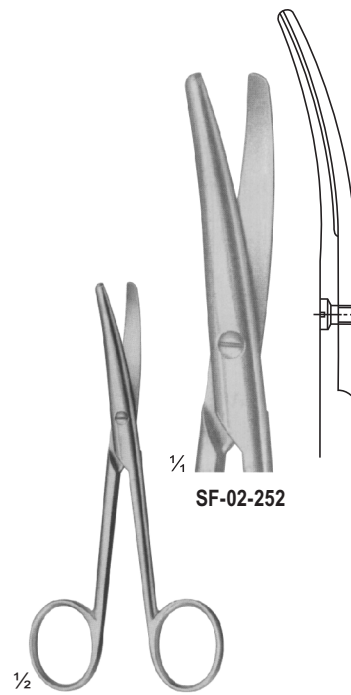

**SF-02-252**

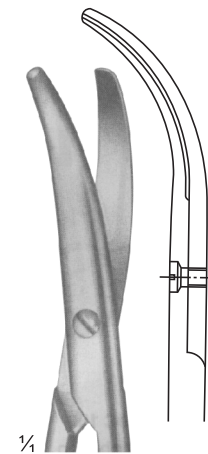

**SF-02-253**

**SF-02-250 - SF-02-251**  
FOMON  
Lower lateral scissors

**SF-02-252 - SF-02-253**  
LANDOLT  
Enucleation scissors  
120 mm

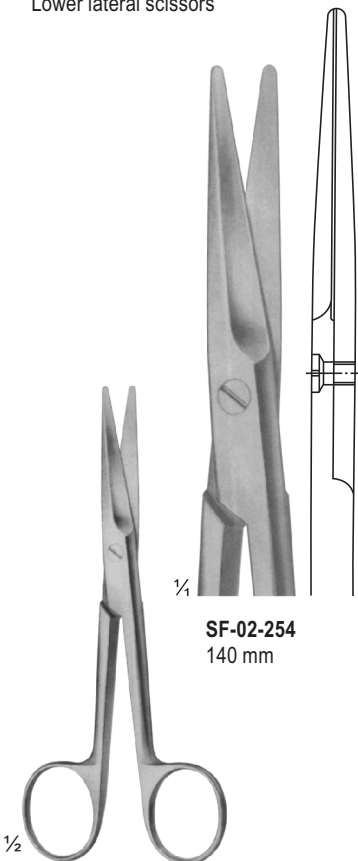

**SF-02-254**  
140 mm

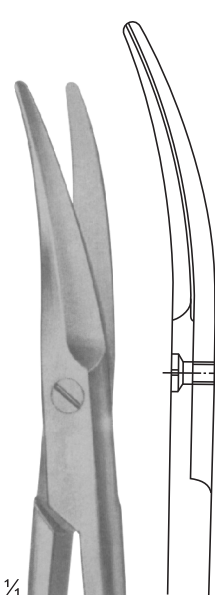

**SF-02-257 - SF-02-259**  
MAYO  
SF-02-257 (140 mm)  
SF-02-258 (155 mm)  
SF-02-259 (170 mm)

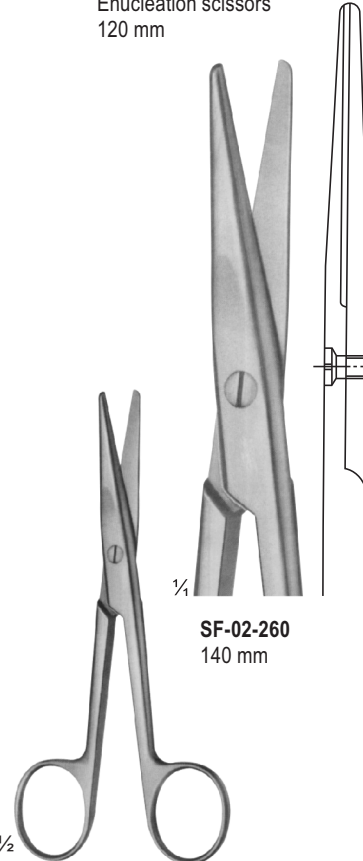

**SF-02-260**  
140 mm

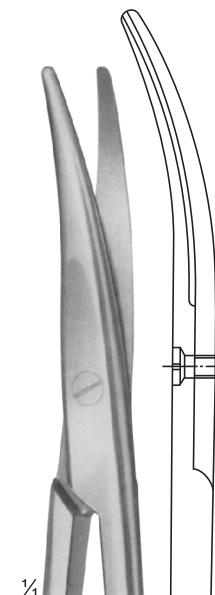

**SF-02-263 - SF-02-264**  
MAYO-STILLE  
SF-02-263 (140 mm)  
SF-02-264 (170 mm)

**SF-02-254 - SF-02-256**  
MAYO  
SF-02-254 (140 mm)  
SF-02-255 (155 mm)  
SF-02-256 (170 mm)

**SF-02-260 - SF-02-262**  
MAYO-STILLE  
SF-02-261 (140 mm)  
SF-02-262 (170 mm)

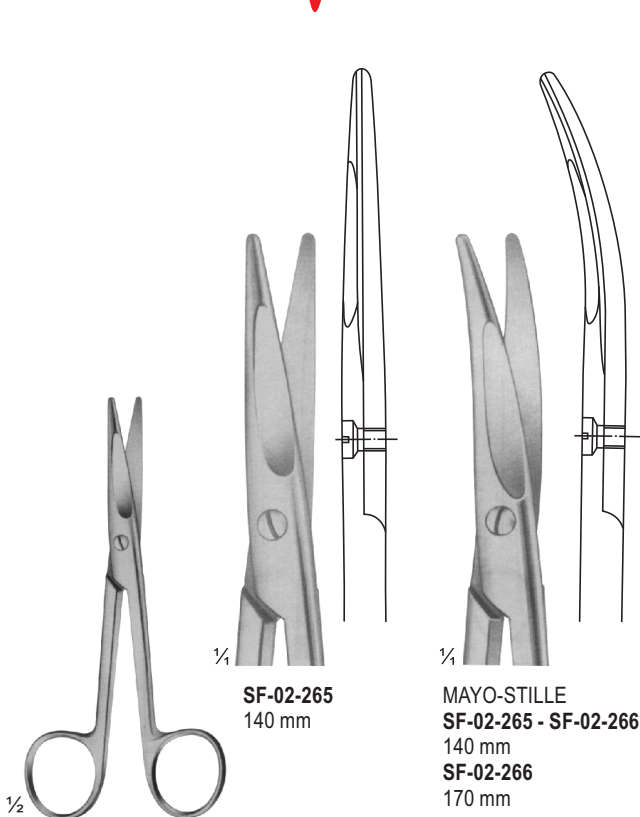

**SF-02-265 - SF-02-266**  
MAYO-STILLE  
With chamfered blades  
SF-02-265 (140 mm)  
SF-02-266 (170 mm)

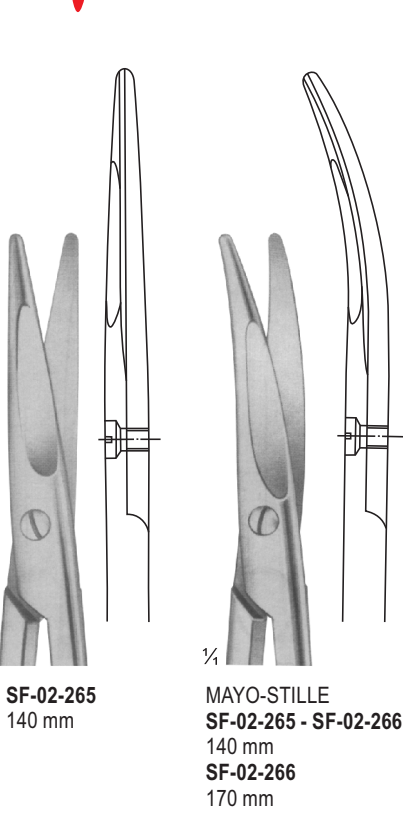

**SF-02-265**  
140 mm

**MAYO-STILLE**  
**SF-02-265 - SF-02-266**  
140 mm  
**SF-02-266**  
170 mm

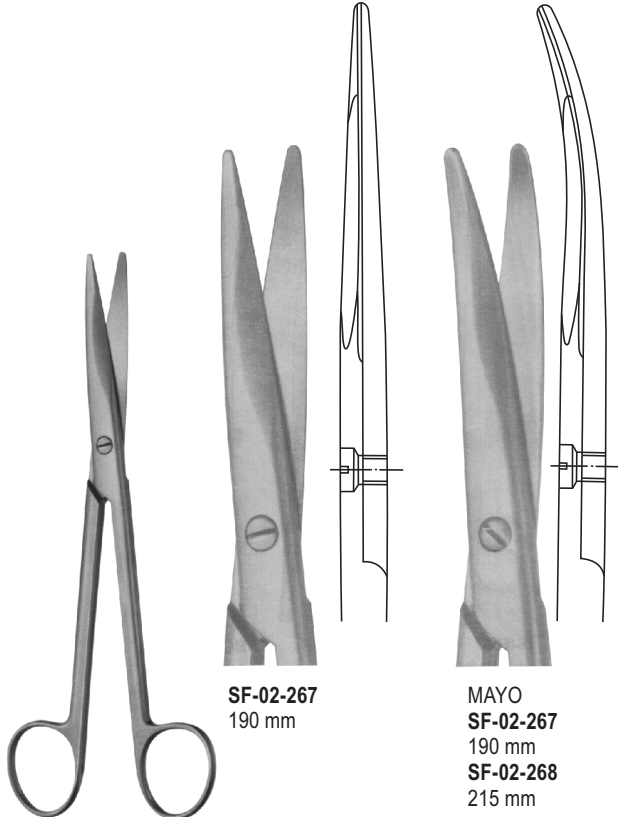

**MAYO**  
With chamfered blades  
SF-02-267 (190 mm)  
SF-02-268 (215 mm)

**SF-02-267**  
190 mm

**MAYO**  
**SF-02-267**  
190 mm  
**SF-02-268**  
215 mm

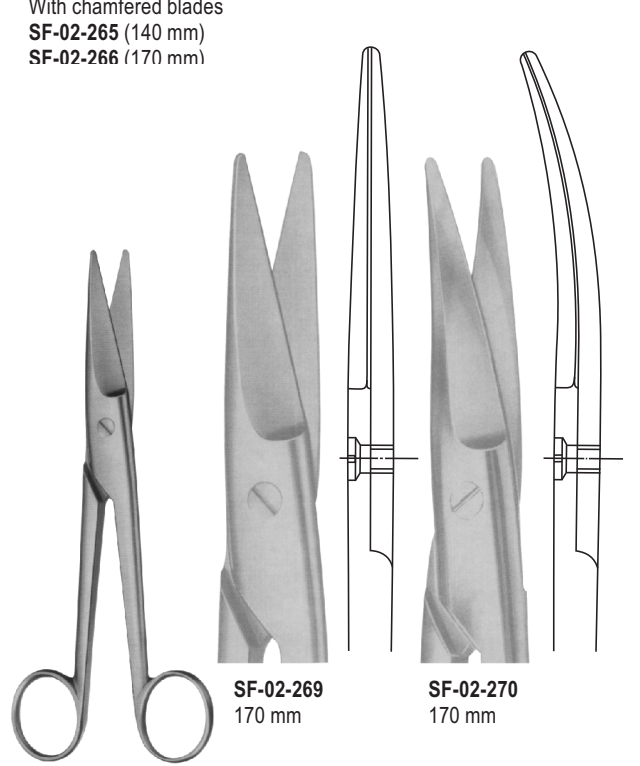

**SF-02-269 - SF-02-270**  
MAYO-NOBLE  
Broad pattern

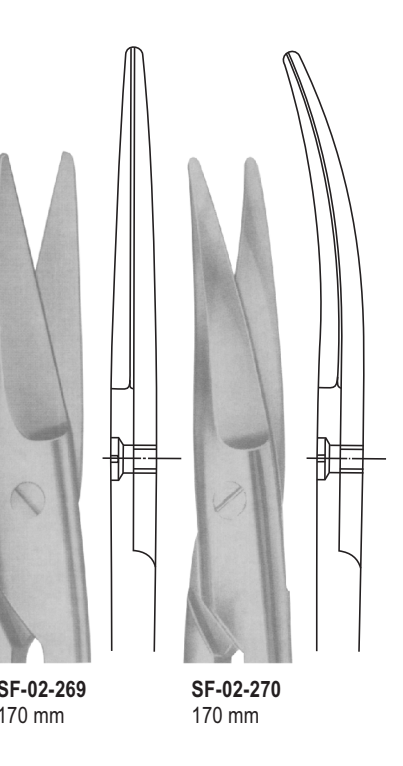

**SF-02-269**  
170 mm

**SF-02-270**  
170 mm

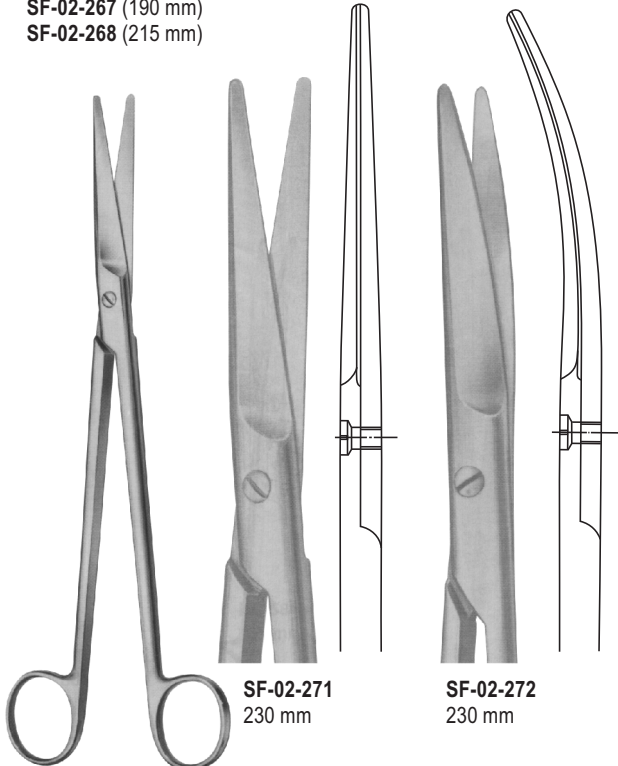

**SF-02-271 - SF-02-272**  
MAYO-HARRINGTON

**SF-02-271**  
230 mm

**SF-02-272**  
230 mm

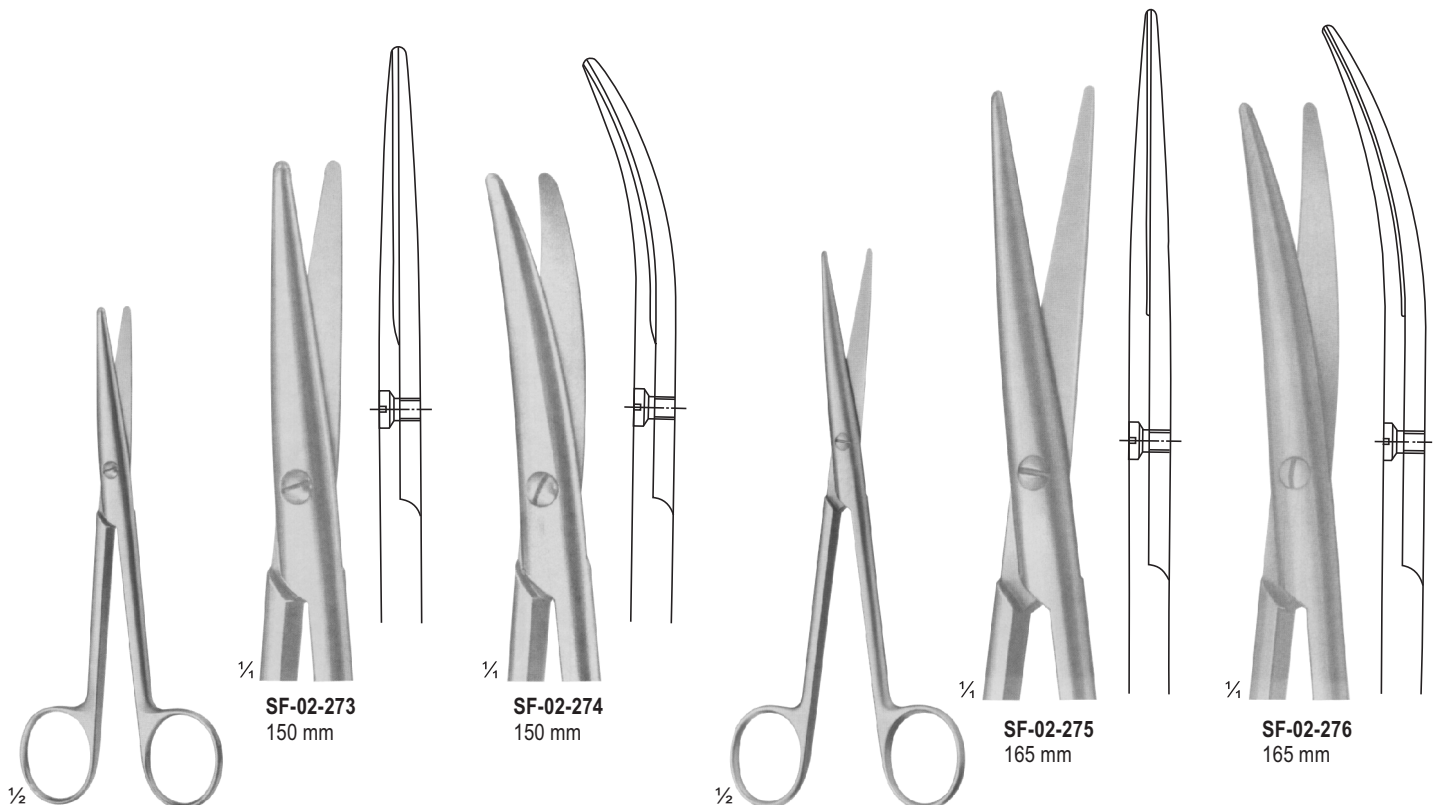

SF-02-273  
150 mm

SF-02-274  
150 mm

SF-02-275  
165 mm

SF-02-276  
165 mm

SF-02-273 - SF-02-274  
STILLE  
150 mm

SF-02-275 - SF-02-276  
LEXER  
Narrow  
165 mm

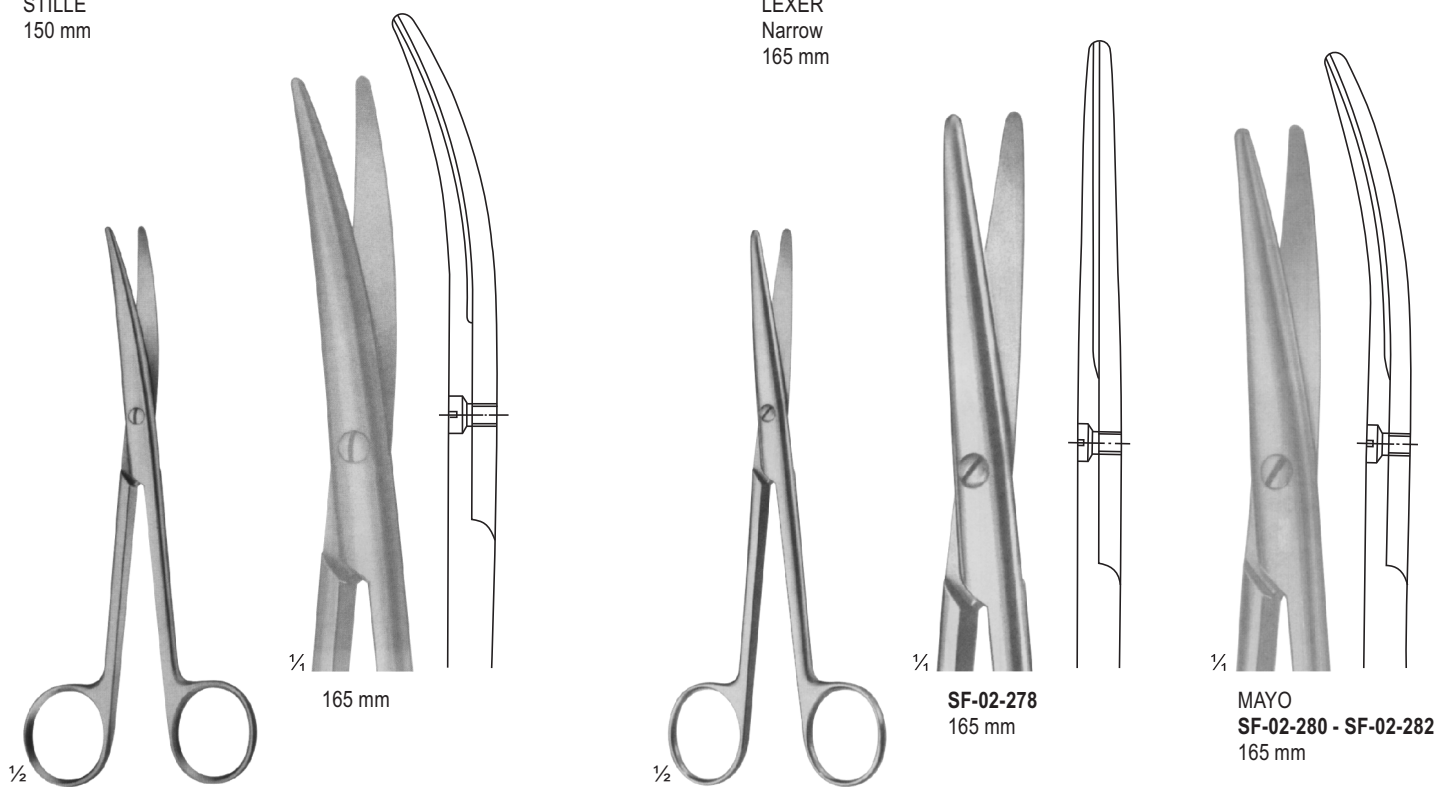

165 mm

SF-02-278  
165 mm

MAYO  
SF-02-280 - SF-02-282  
165 mm

SF-02-277  
MAYO-LEXER  
Standard

SF-02-278 - SF-02-279  
MAYO  
SF-02-278 (165 mm)  
SF-02-279 (200 mm)

SF-02-281  
200 mm  
SF-02-282  
210 mm

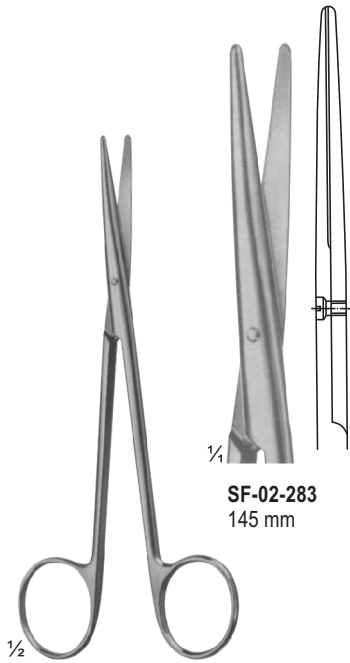

**SF-02-283**  
145 mm

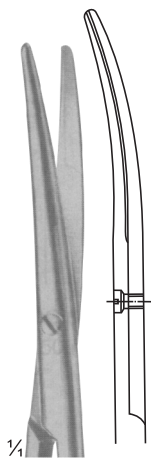

**SF-02-284**  
145 mm

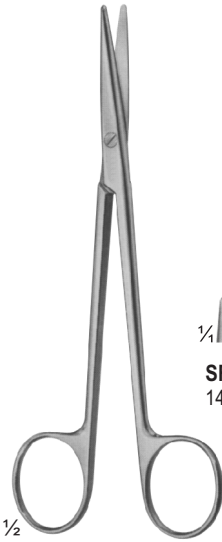

**SF-02-285 - SF-02-290**  
METZENBAUM

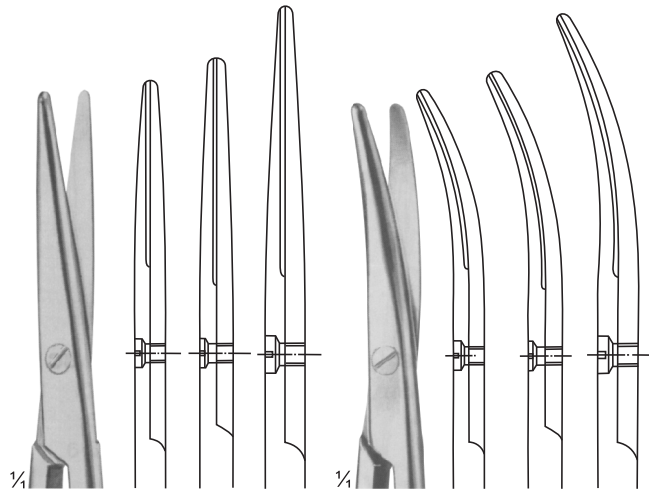

**SF-02-285** 145 mm  
**SF-02-286** 180 mm  
**SF-02-287** 200 mm  
**SF-02-288** 145 mm  
**SF-02-289** 180 mm  
**SF-02-290** 200 mm



**SF-02-291 - SF-02-298**  
NELSON - METZENBAUM

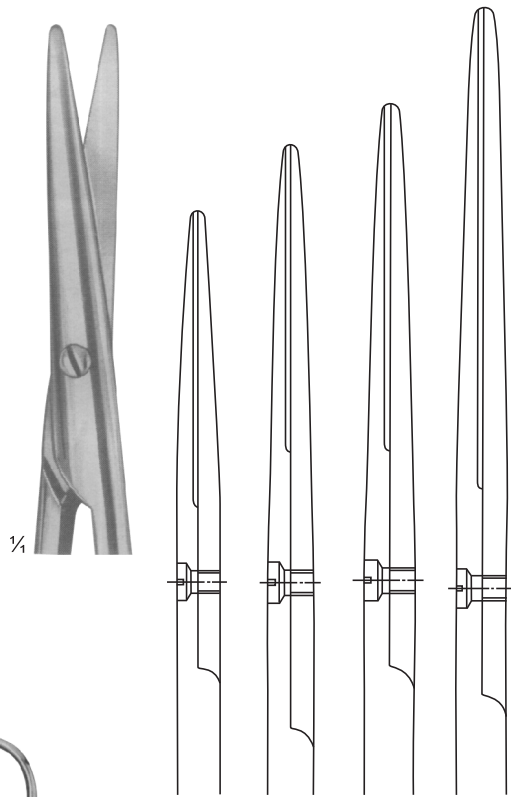

**SF-02-291** 230 mm  
**SF-02-292** 250 mm  
**SF-02-293** 280 mm  
**SF-02-294** 305 mm

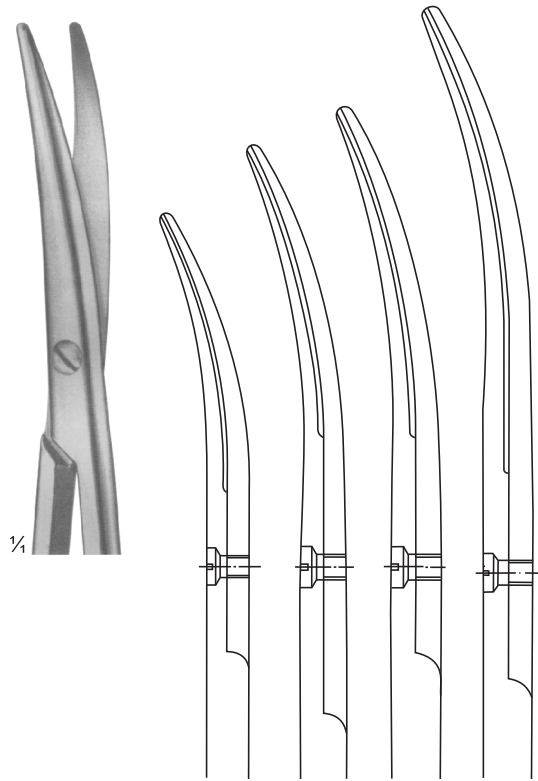

**SF-02-295** 230 mm  
**SF-02-296** 250 mm  
**SF-02-297** 280 mm  
**SF-02-298** 305 mm

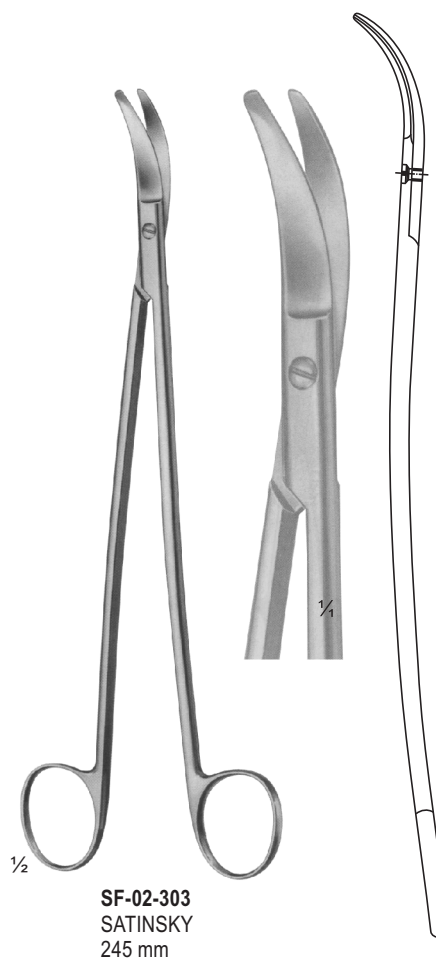
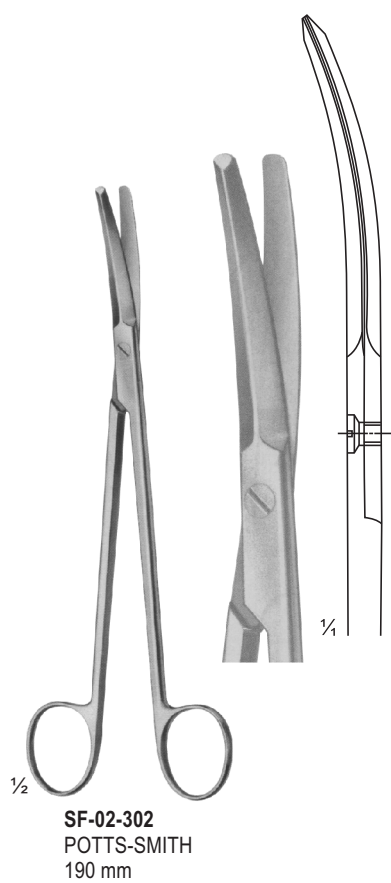
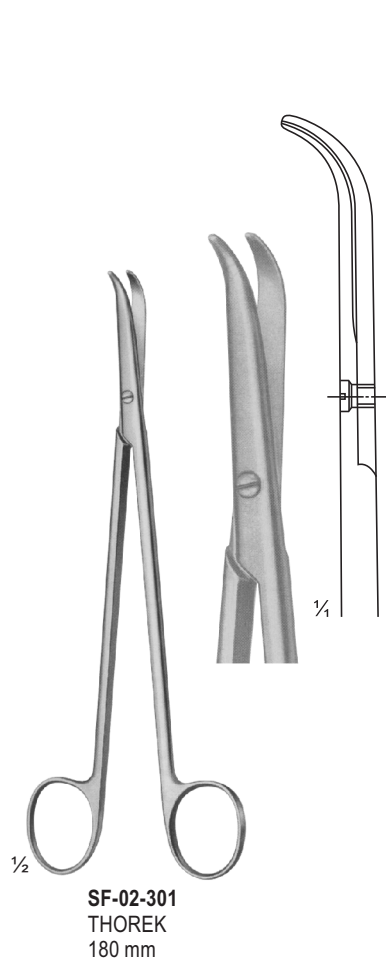
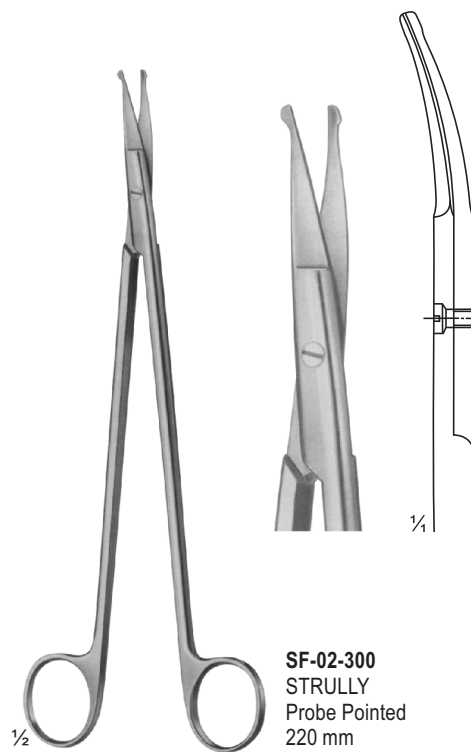
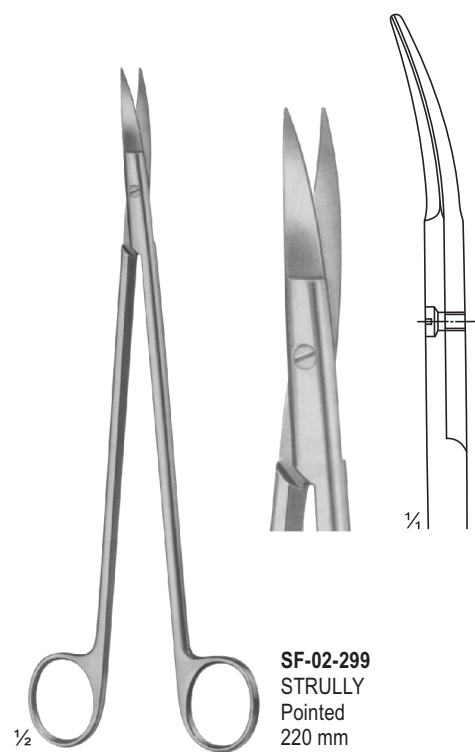

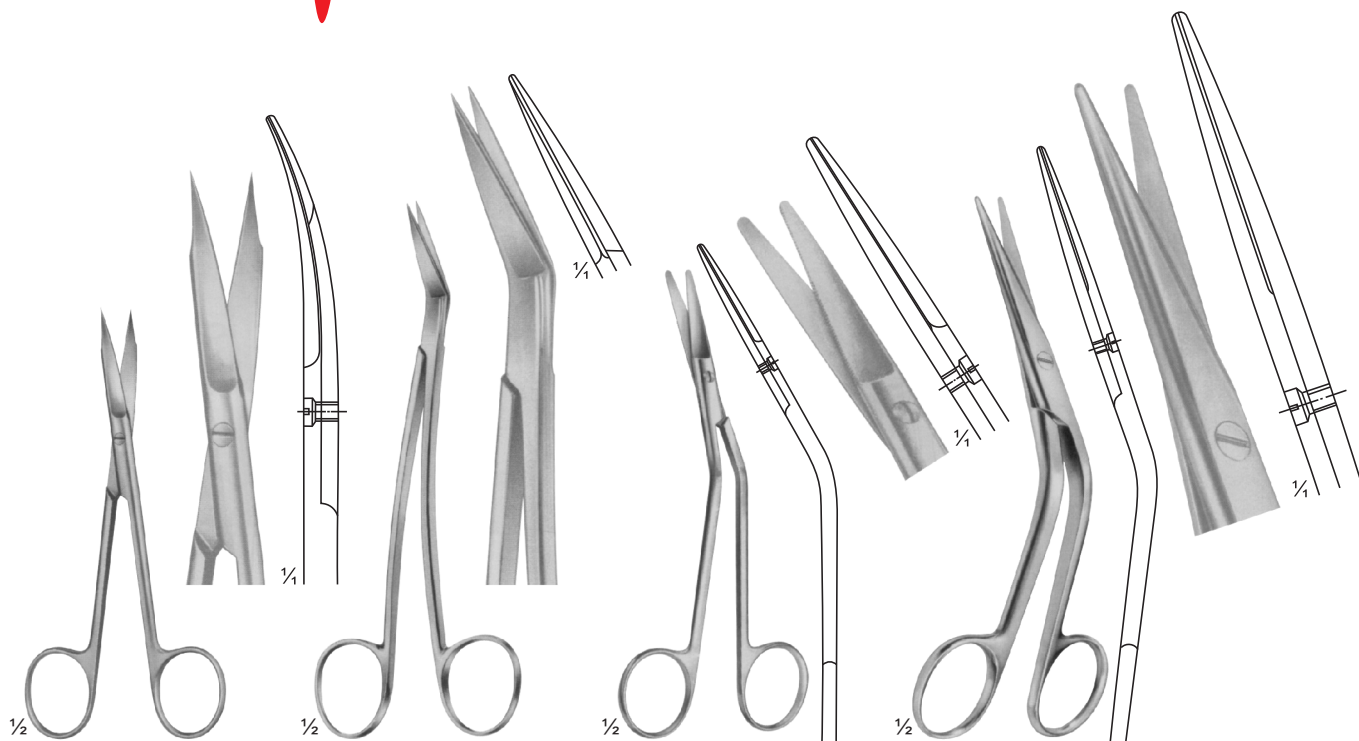

**SF-02-304**  
Goldman-Fox  
1 Finely Toothed Blade  
130 mm

**SF-02-305**  
LOCKLIN  
Curved Sideways,  
1 Toothed Blade  
155 mm

**SF-02-306**  
FOMON  
Blades Serrated  
145 mm

**SF-02-307**  
COTTLE  
165 mm

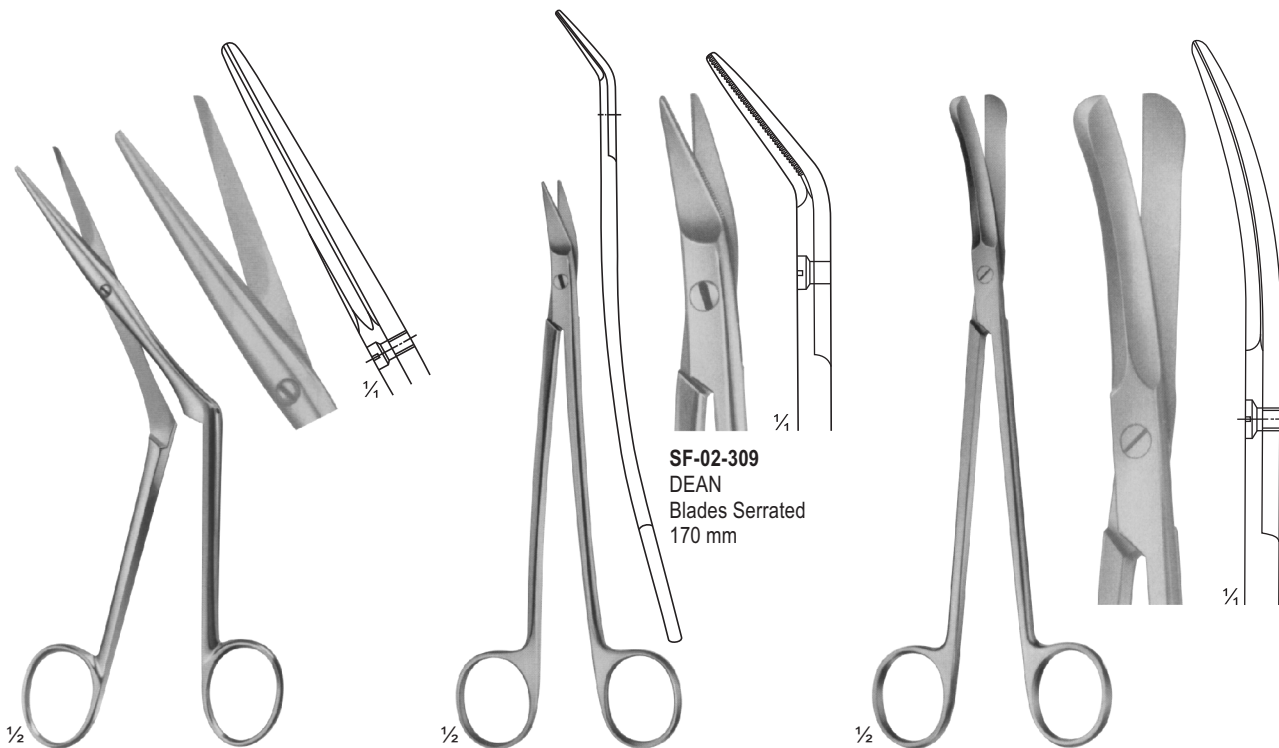

**SF-02-308**  
HEYMANN-KNIGHT  
175 mm

**SF-02-309**  
DEAN  
Blades Serrated  
170 mm

**SF-02-310**  
GOOD  
195 mm

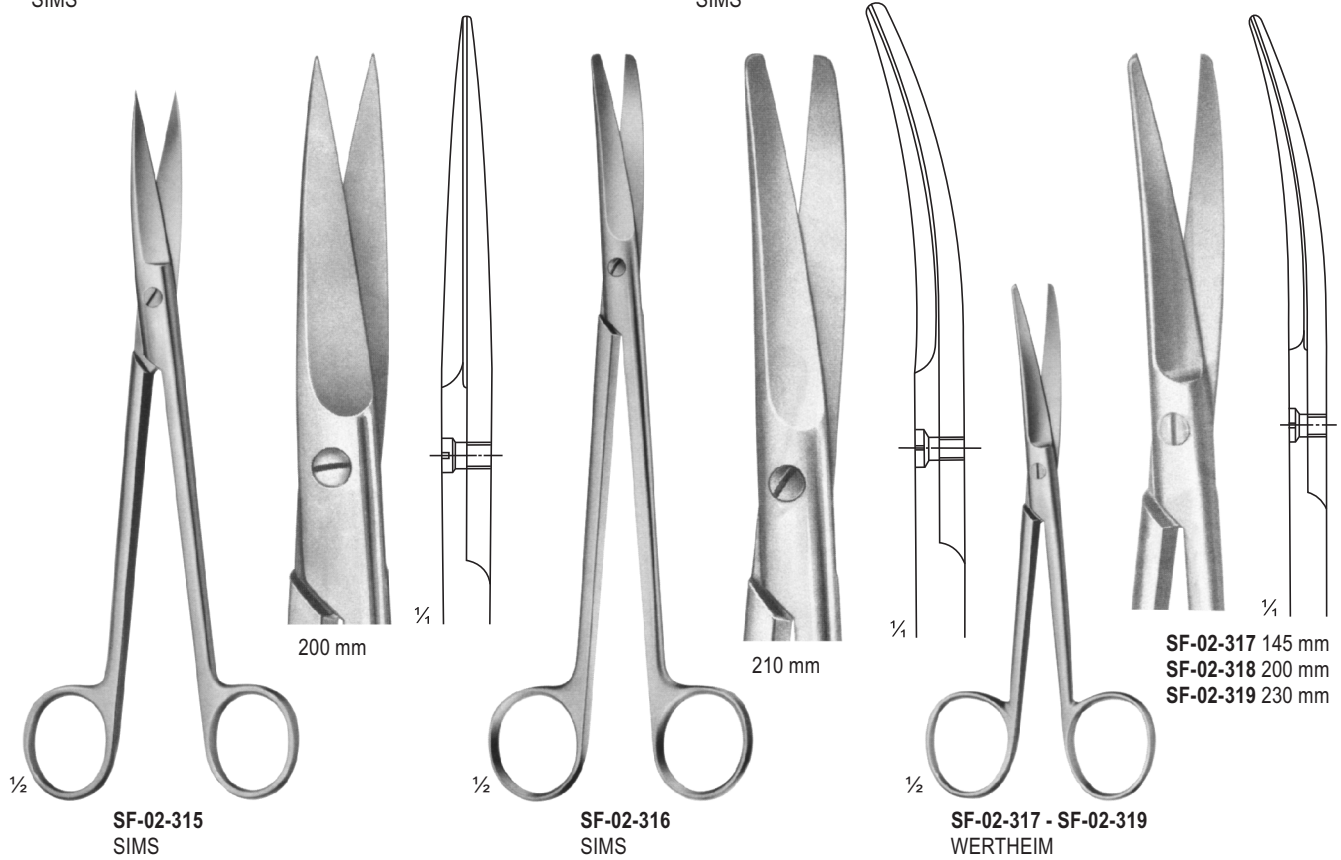
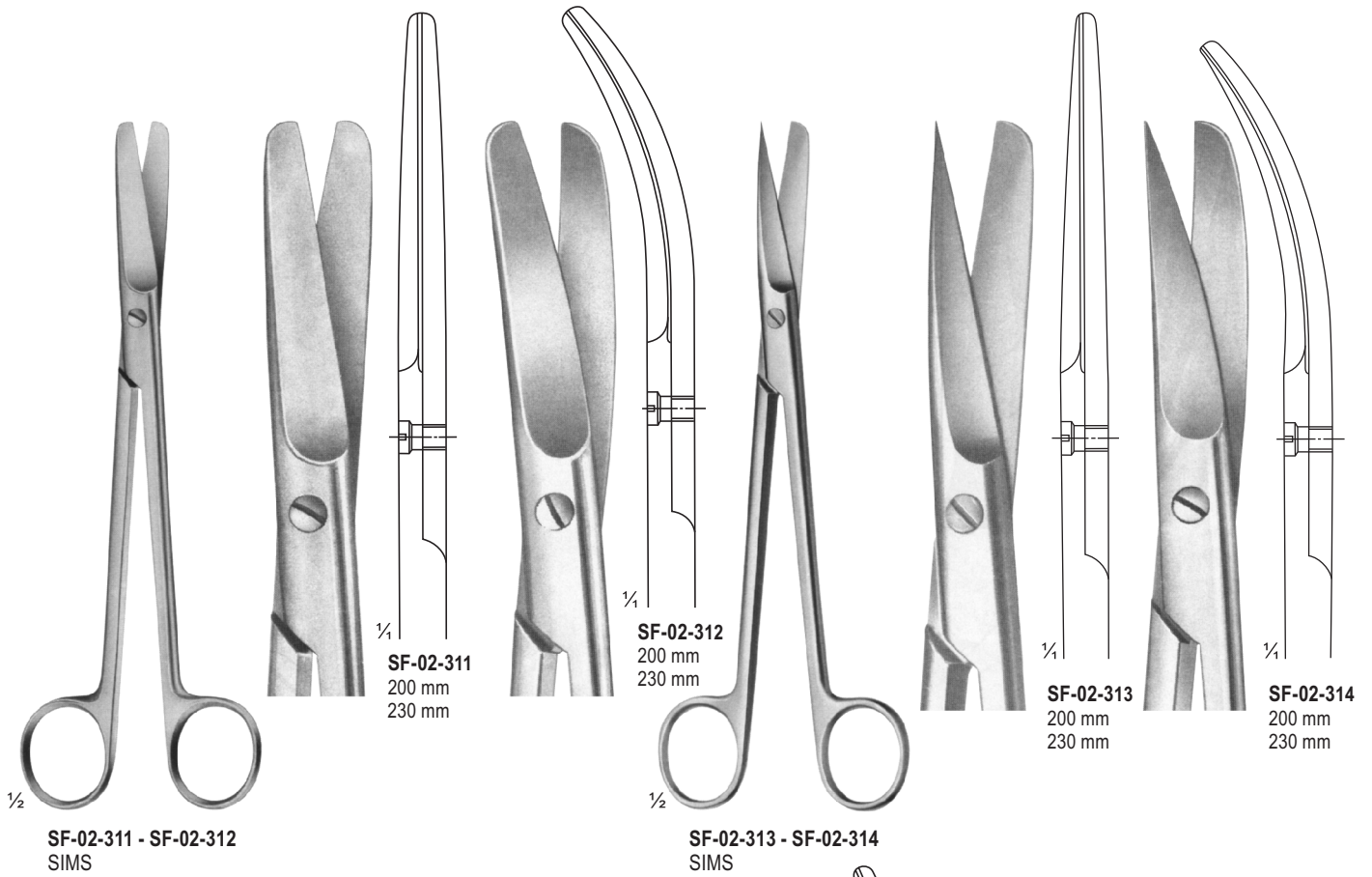

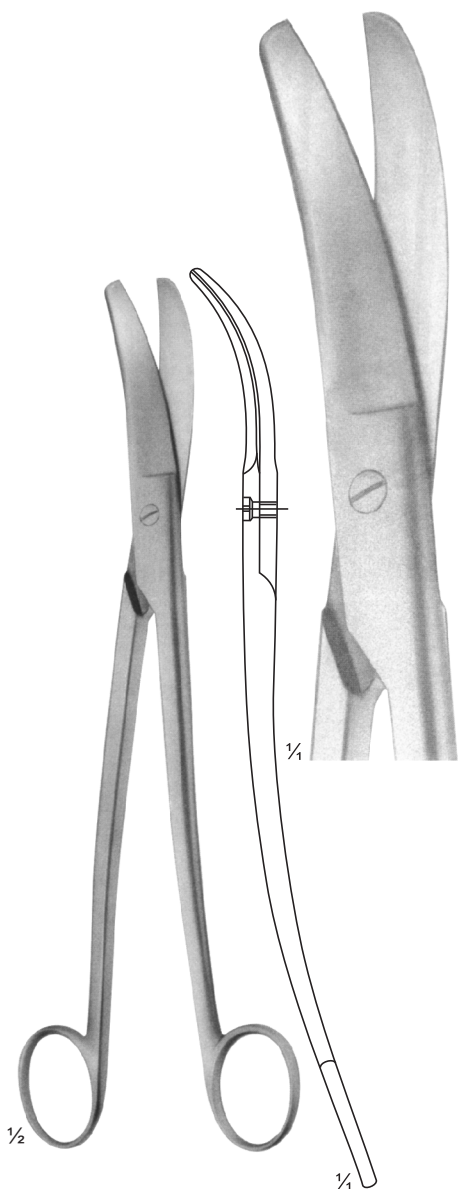

**SF-02-320**  
SIEBOLD  
Uterine Scissors  
245 mm

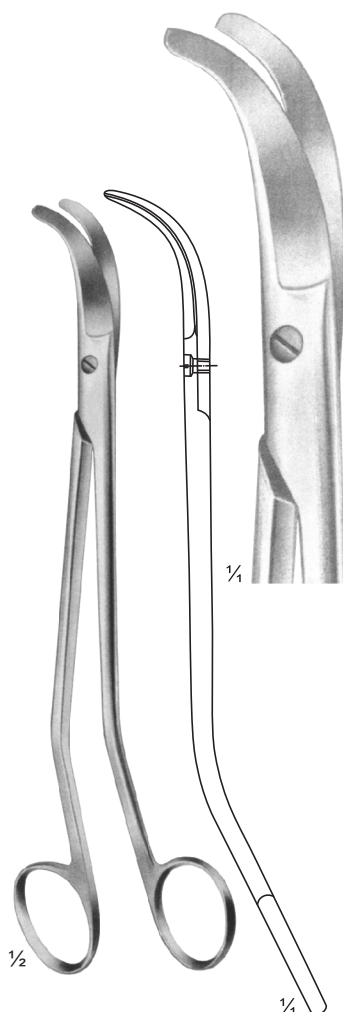

**SF-02-321**  
BOZEMANN  
Uterine Scissors  
220 mm

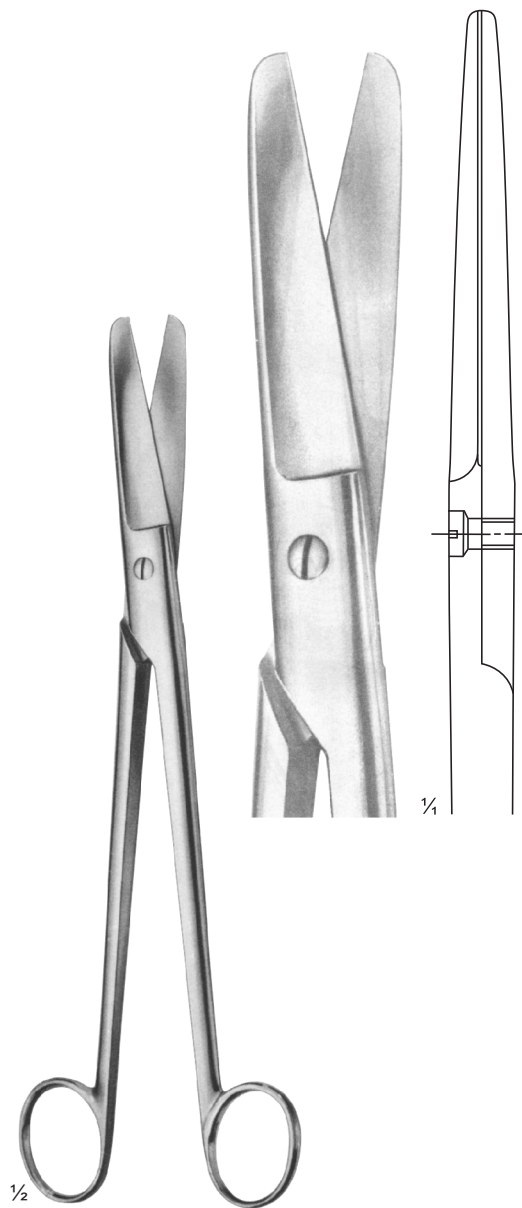

**SF-02-322**  
SIMS-SIEBOLD  
Uterine Scissors  
250 mm



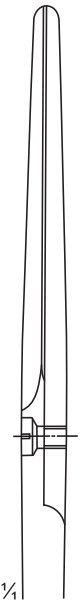
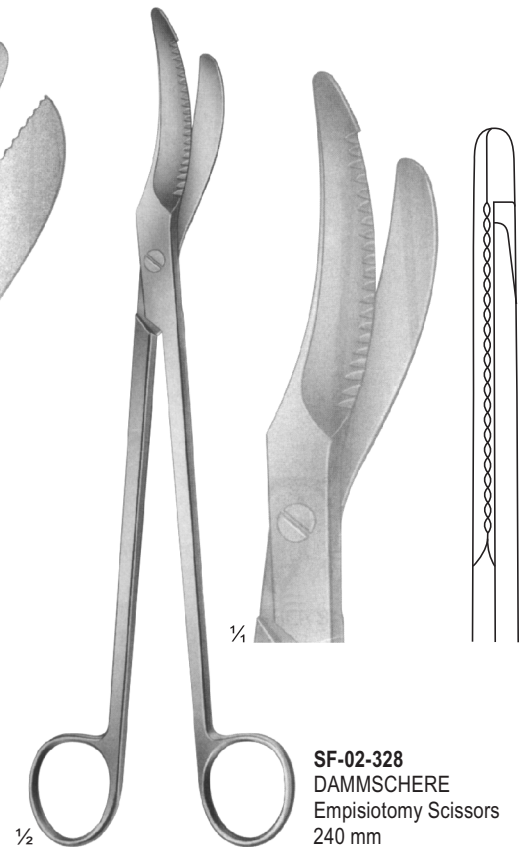
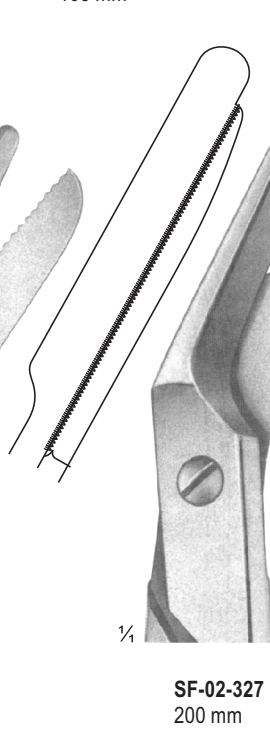
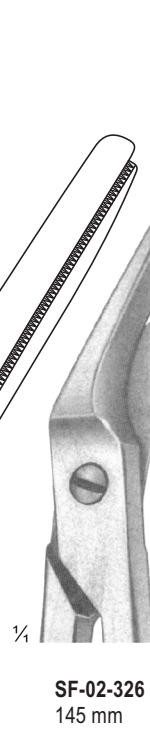
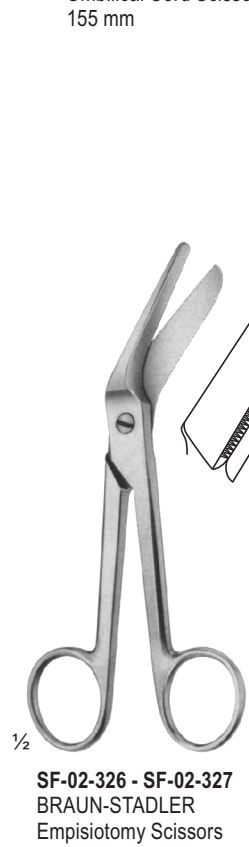
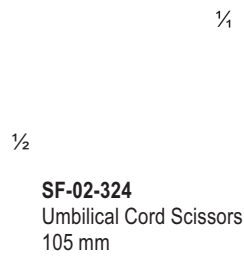
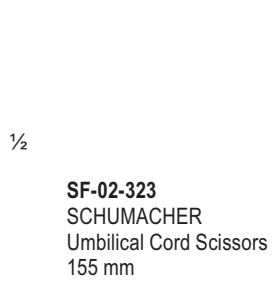

135 mm

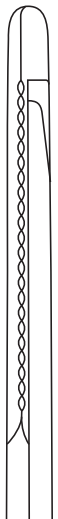

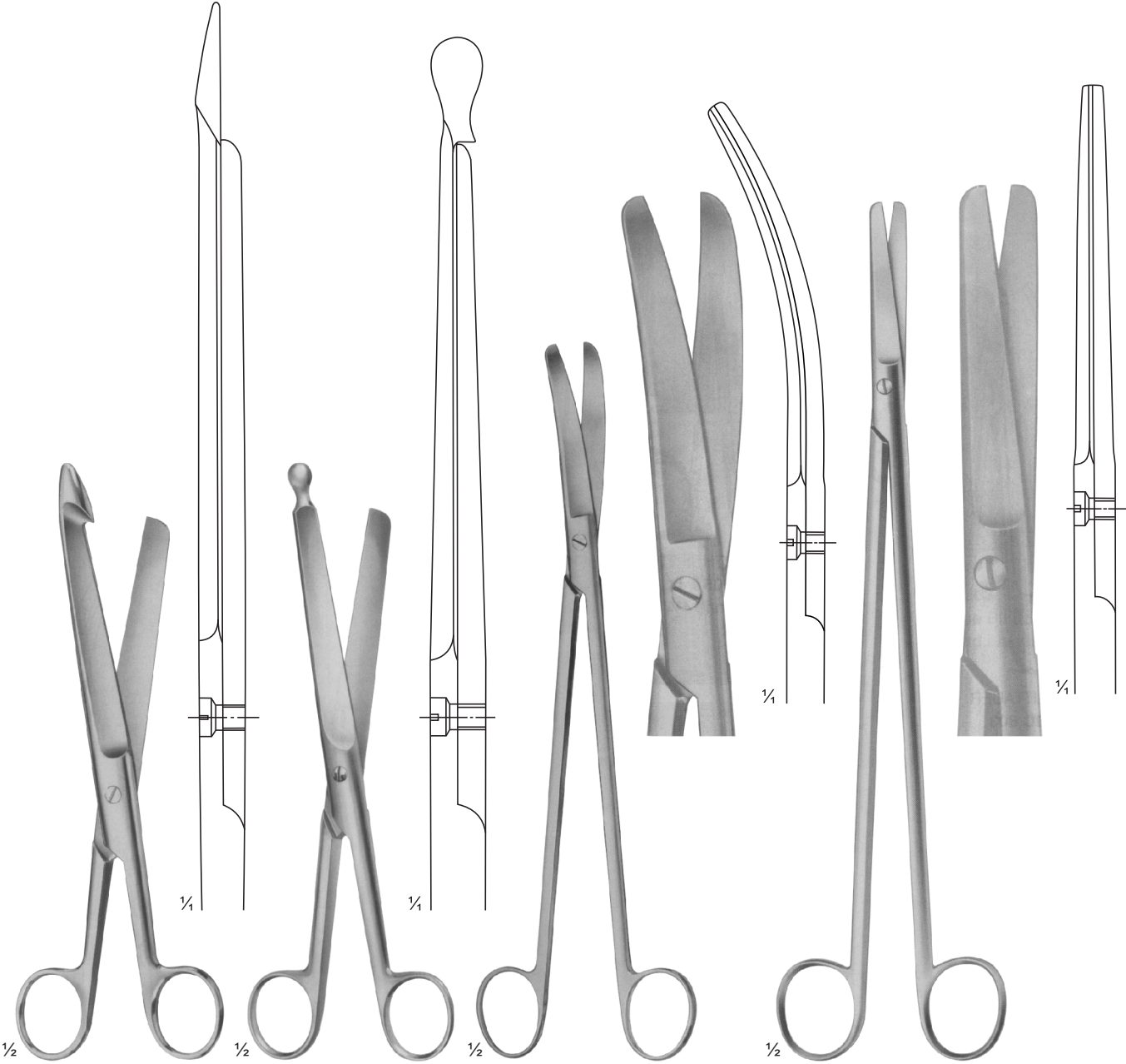

**SF-02-329**  
DAMMSCHERE  
Bowel Scissors  
210 mm

**SF-02-330**  
DAMMSCHERE  
Bowel Scissors  
210 mm

**SF-02-331**  
LLOYD-DAVIES  
(GOLIGHER'S)  
Rectal Scissors  
255 mm

**SF-02-332**  
STELZNER  
Rectal Scissors  
310 mm

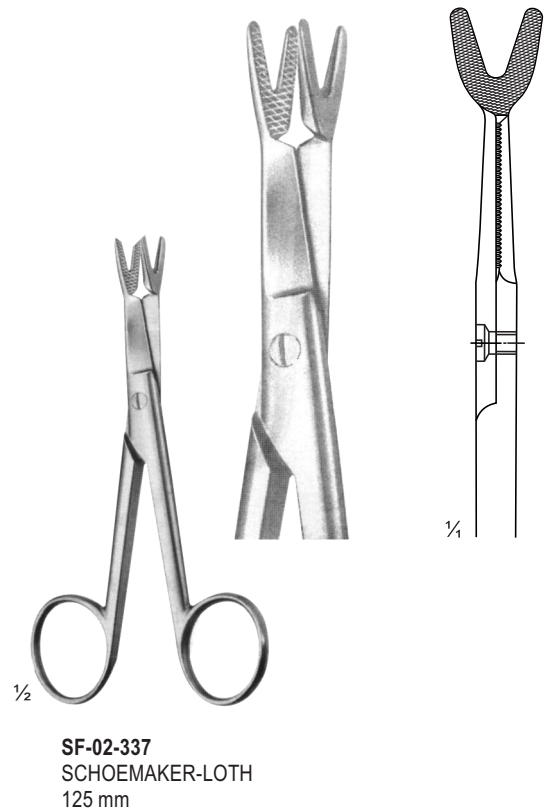
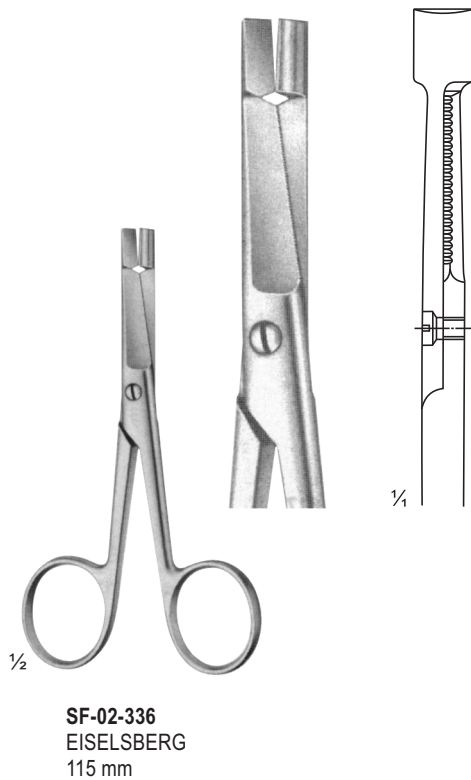
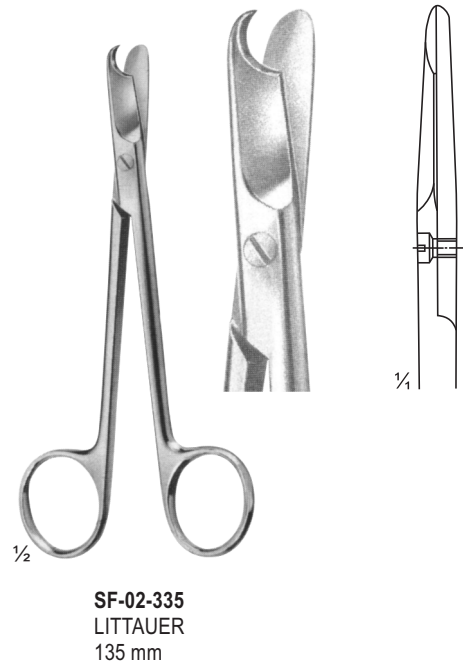
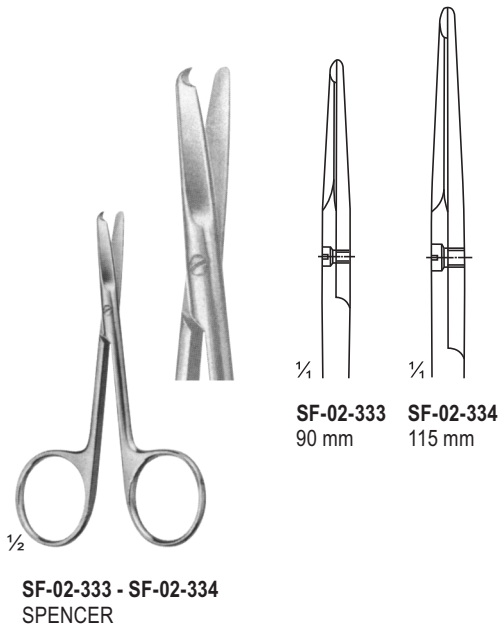

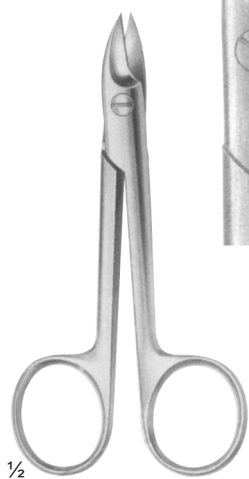

1/2

**SF-02-338 - SF-02-342**  
BEEBE  
110 mm

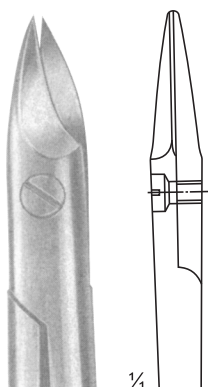

1/4

**SF-02-338**

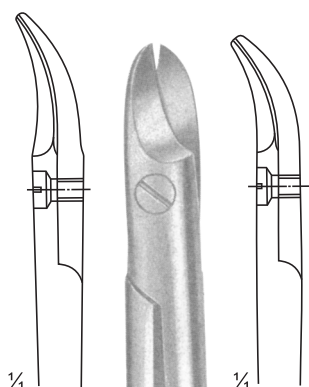

1/4

**SF-02-339**

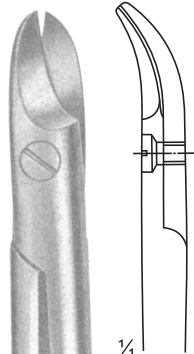

1/4

**SF-02-340**  
Broad Blades

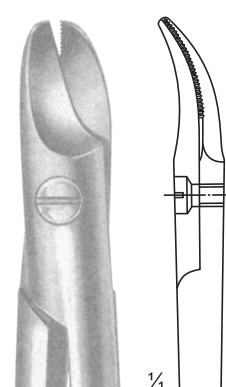

1/4

**SF-02-341**  
1 Blade Serrated

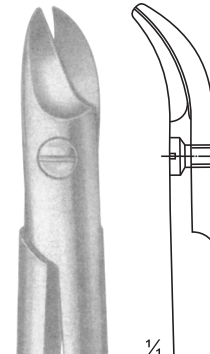

1/4

**SF-02-342**  
NAUJOKS  
Strongly Curved

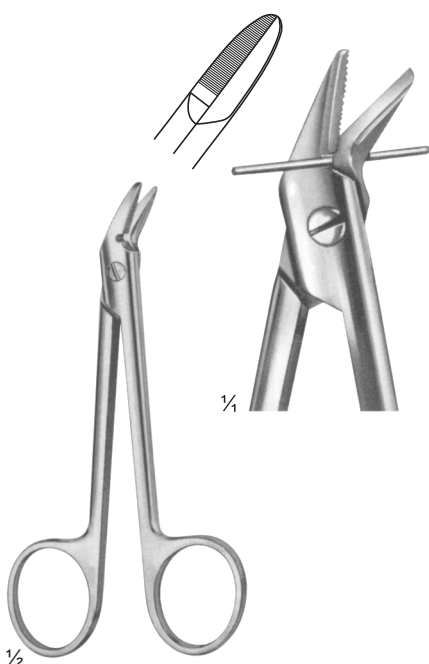

1/2

**SF-02-343**  
1 Blade Serrated  
120 mm

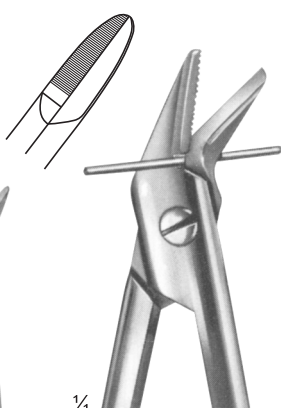

1/4

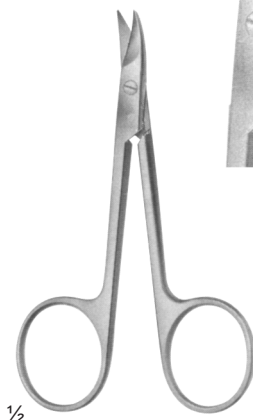

1/2

**SF-02-344**  
STRACK  
100 mm

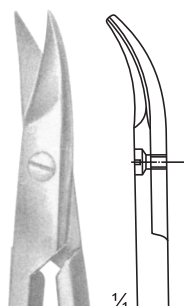

1/4

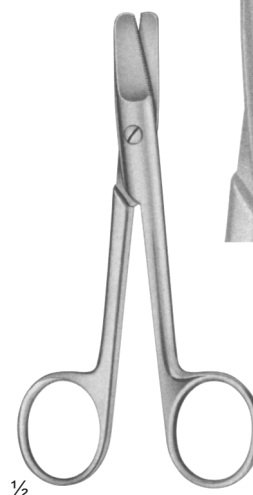

1/2

**SF-02-345**  
HARVEY  
125 mm

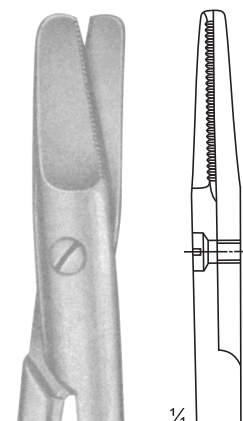

1/4

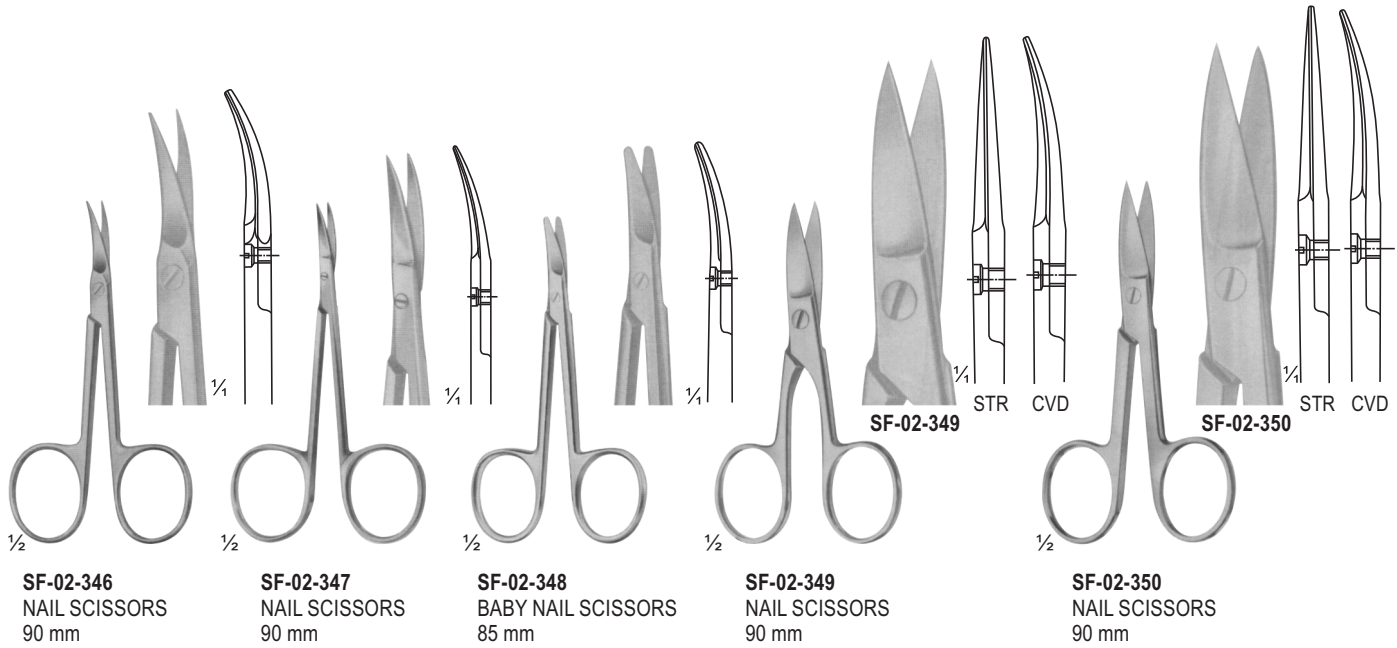

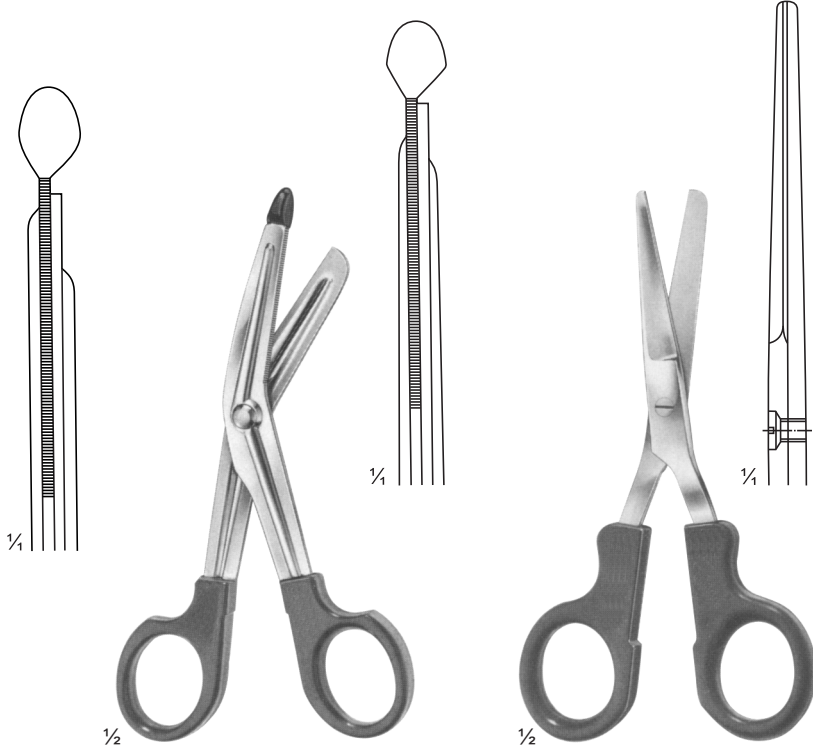

1/2

**SF-02-356**  
UNIVERSAL AND BANDAGE SCISSORS  
180 mm

1/2

**SF-02-357**  
LISTER  
145 mm

1/2

**SF-02-358**  
LISTER  
145 mm

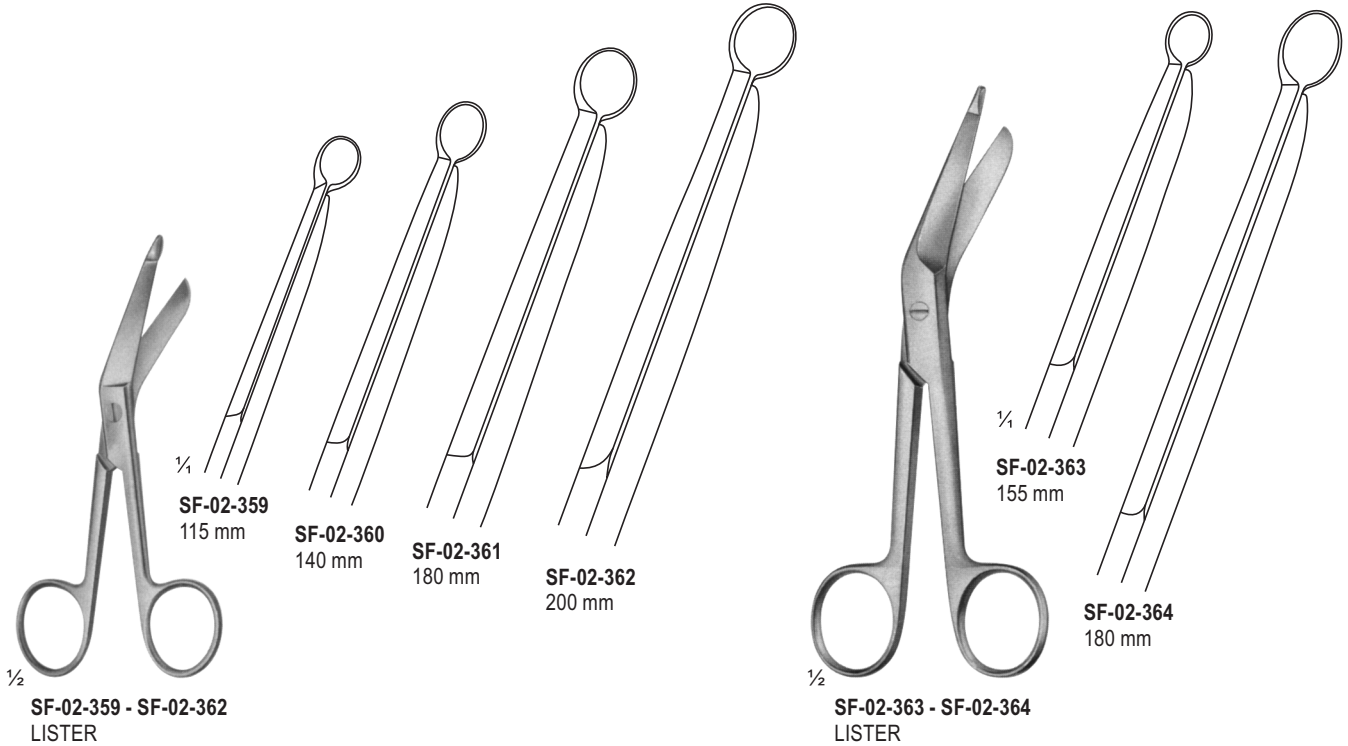

1/2

**SF-02-359 - SF-02-362**  
LISTER

**SF-02-359**  
115 mm

**SF-02-360**  
140 mm

**SF-02-361**  
180 mm

**SF-02-362**  
200 mm

1/2

**SF-02-363 - SF-02-364**  
LISTER

**SF-02-363**  
155 mm

**SF-02-364**  
180 mm



**SF-02-365**  
CLOTH SCISSORS  
205 mm

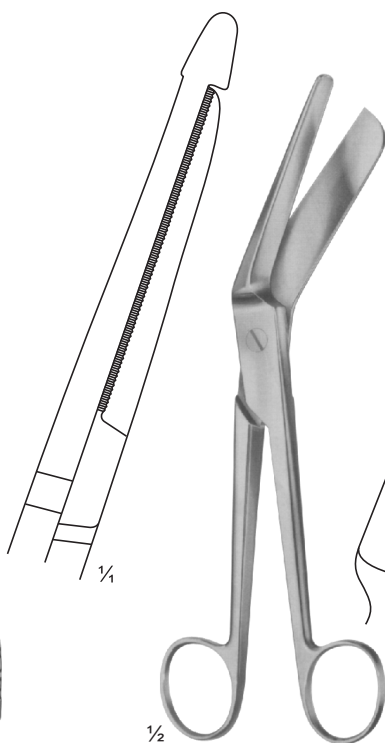

**SF-02-366**  
BRAUN-STADLER  
225 mm

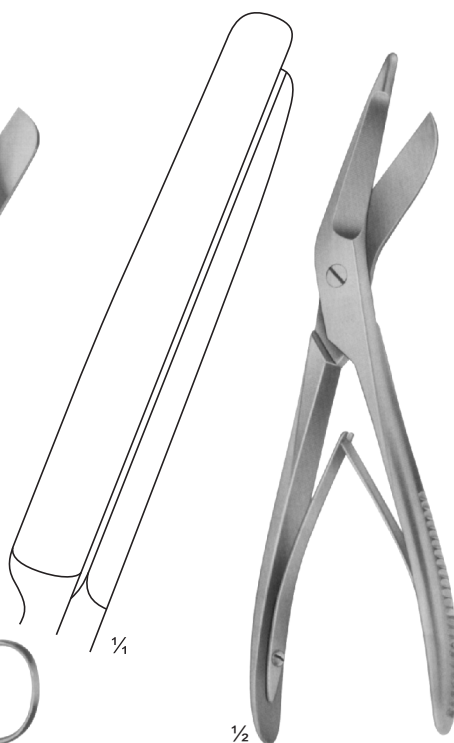

**SF-02-367**  
SEUTIN  
230 mm

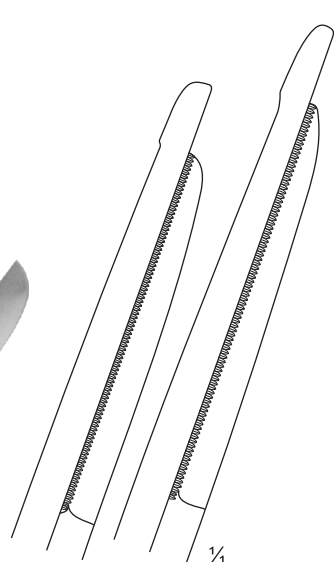
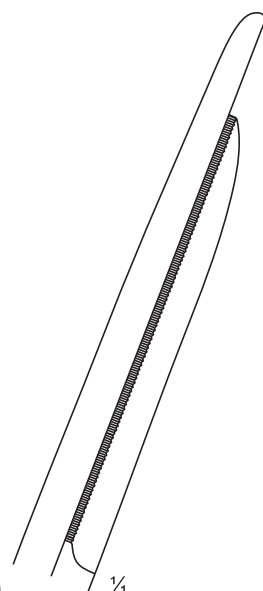

**SF-02-368** 200 mm  
**SF-02-369** 230 mm



**SF-02-368 - SF-02-369**  
ESMARCH

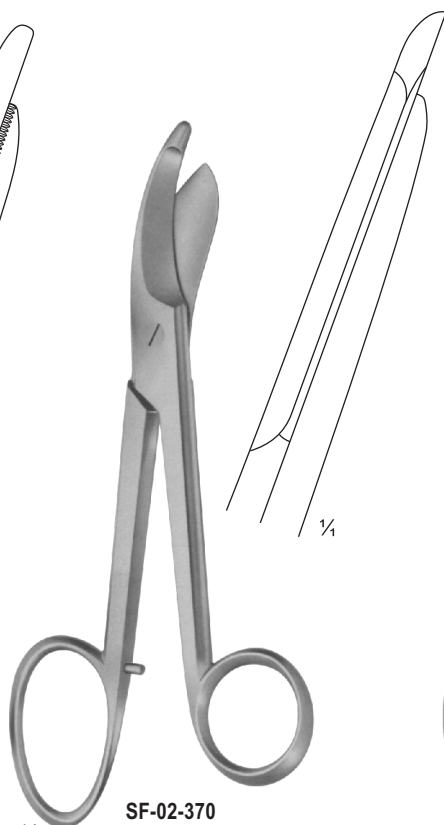

**SF-02-370**  
BRUNS  
235 mm

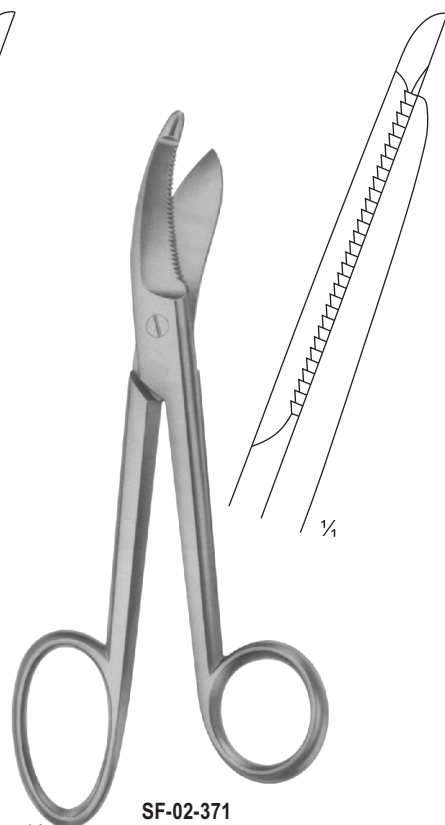

**SF-02-371**  
BRUNS  
235 mm

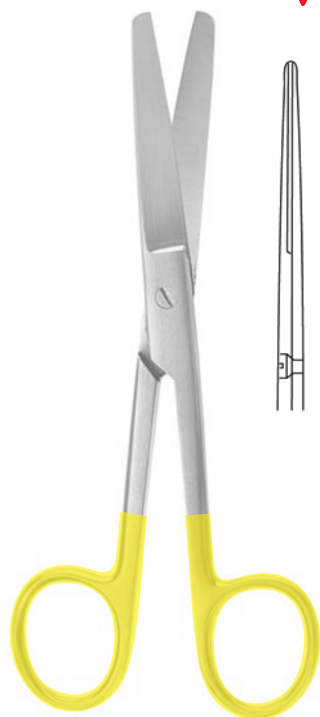

STANDARD  
**SF-02-372** 14.5 cm, 5 3/4"  
**SF-02-373** 16.5 cm, 6 1/2"  
**SF-02-374** 18.5 cm, 7 1/4"



STANDARD  
**SF-02-375** 14.5 cm, 5 3/4"  
**SF-02-376** 16.5 cm, 6 1/2"  
**SF-02-377** 18.5 cm, 7 1/4"



STANDARD  
**SF-02-378** 14.5 cm, 5 3/4"  
**SF-02-379** 16.5 cm, 6 1/2"  
**SF-02-380** 18.5 cm, 7 1/4"

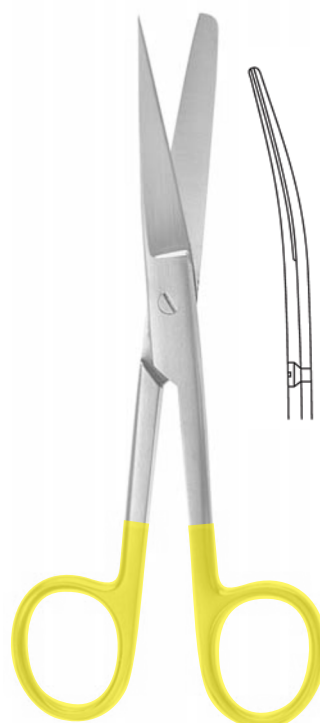

STANDARD  
**SF-02-381** 14.5 cm, 5 3/4"  
**SF-02-382** 16.5 cm, 6 1/2"  
**SF-02-383** 18.5 cm, 7 1/4"

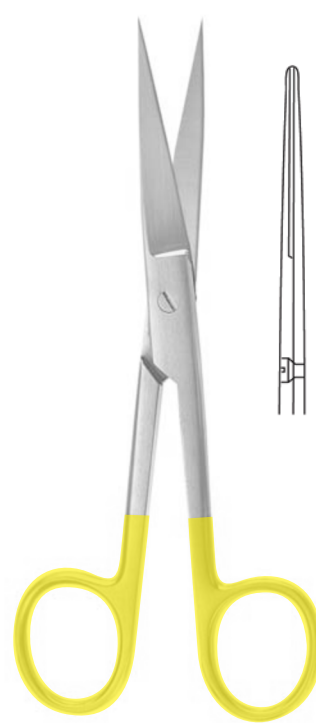

STANDARD  
**SF-02-384** 14.5 cm, 5 3/4"  
**SF-02-385** 16.5 cm, 6 1/2"  
**SF-02-386** 18.5 cm, 7 1/4"

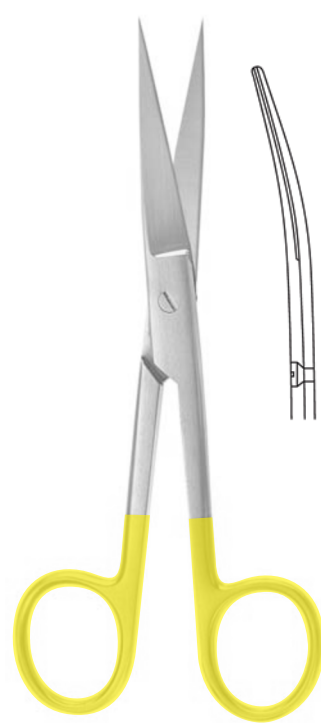

STANDARD  
**SF-02-387** 14.5 cm, 5 3/4"  
**SF-02-388** 16.5 cm, 6 1/2"  
**SF-02-389** 18.5 cm, 7 1/4"



SURGICAL SCISSORS WITH TUNGSTEN CARBIDE EDGES

[www.surgiforce.com](http://www.surgiforce.com)

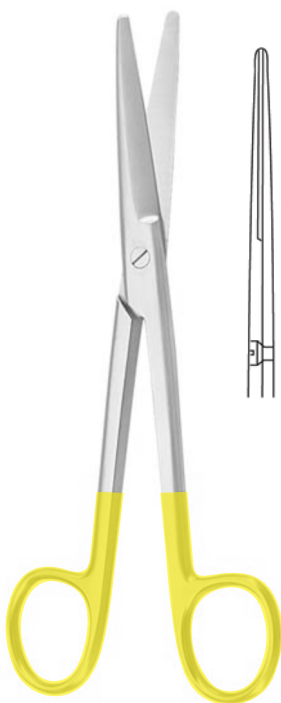

MAYO  
**SF-02-390** 14.5 cm, 5 3/4"  
**SF-02-391** 17.0 cm, 6 3/4"  
**SF-02-392** 23.0 cm, 9"

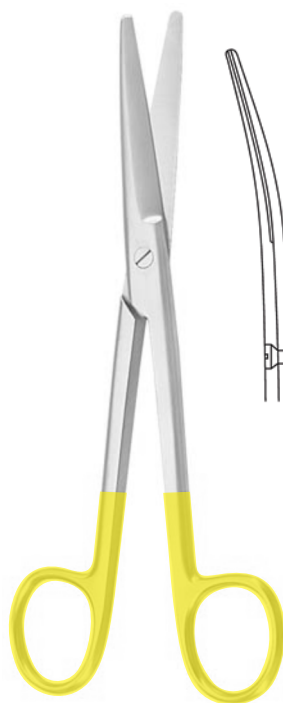

MAYO  
**SF-02-393** 14.5 cm, 5 3/4"  
**SF-02-394** 17.0 cm, 6 3/4"  
**SF-02-395** 23.0 cm, 9"

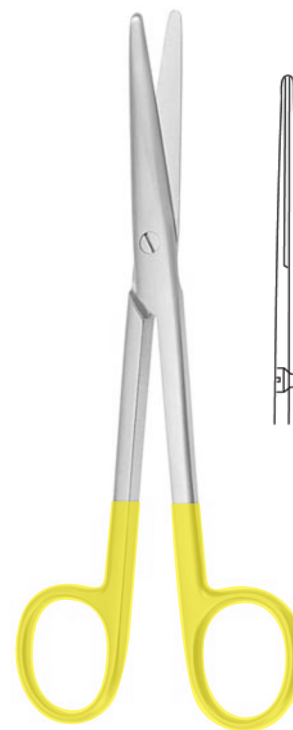

MAYO-STILLE  
**SF-02-396** 15.0 cm, 6"  
**SF-02-397** 17.0 cm, 6 3/4"

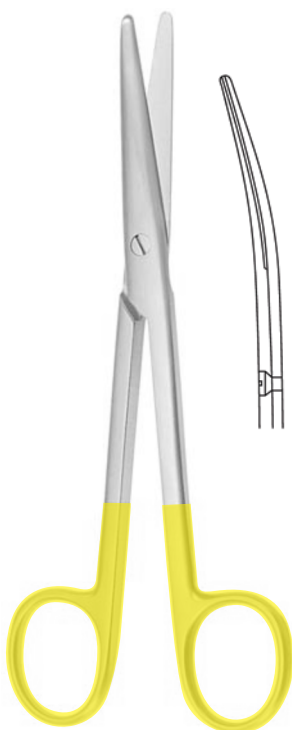

MAYO-STILLE  
**SF-02-398** 15.0 cm, 6"  
**SF-02-399** 17.0 cm, 6 3/4"



LEXER  
**SF-02-400** 16.0 cm, 6 1/4"  
**SF-02-401** 21.0 cm, 8 1/4"



LEXER  
**SF-02-402** 16.0 cm, 6 1/4"  
**SF-02-403** 21.0 cm, 8 1/4"

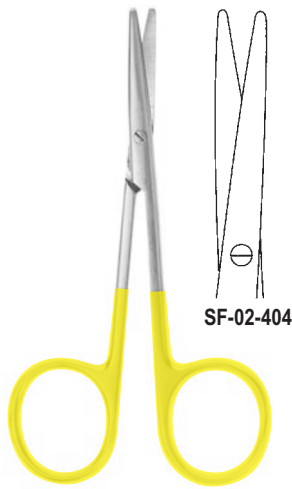

SF-02-404

BABY-METZENBAUM  
SF-02-404 - SF-02-405  
11.5 cm, 4½"



SF-02-405



SF-02-406

METZENBAUM  
SF-02-406 - SF-02-407  
14.5 cm, 5 3/4"

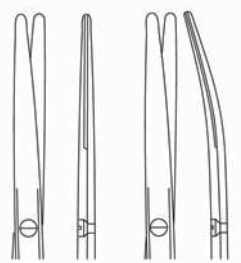

SF-02-407



SF-02-408

METZENBAUM  
SF-02-408 - SF-02-409  
14.5 cm, 5 3/4"

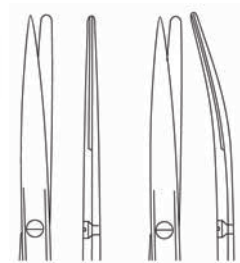

SF-02-409



SF-02-410

METZENBAUM  
SF-02-410 - SF-02-411  
14.5 cm, 5 3/4"

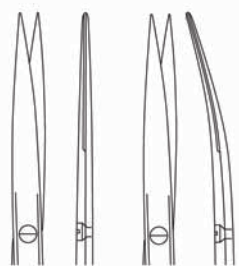

SF-02-411

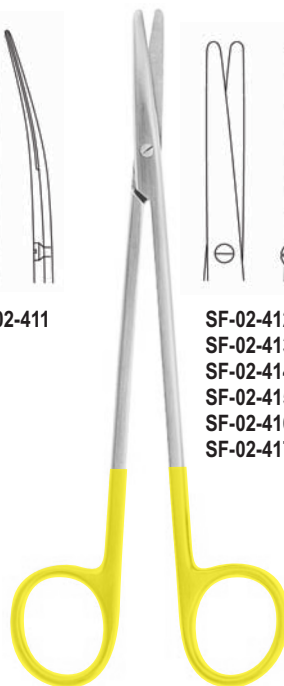

SF-02-412 18.0 cm, 7"  
SF-02-413 20.0 cm, 8"  
SF-02-414 23.0 cm, 9"  
SF-02-415 25.0 cm, 10"  
SF-02-416 28.0 cm, 11"  
SF-02-417 30.0 cm, 12"

METZENBAUM  
SF-02-412 - SF-02-417

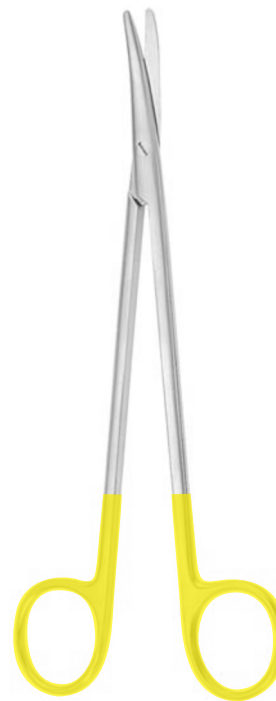

SF-02-418 18.0 cm, 7"  
SF-02-419 20.0 cm, 8"  
SF-02-420 23.0 cm, 9"  
SF-02-421 25.0 cm, 10"  
SF-02-422 28.0 cm, 11"  
SF-02-423 30.0 cm, 12"

METZENBAUM  
SF-02-418 - SF-02-423



# DISSECTING SCISSORS WITH TUNGSTEN CARBIDE EDGES

[www.surgiforce.com](http://www.surgiforce.com)

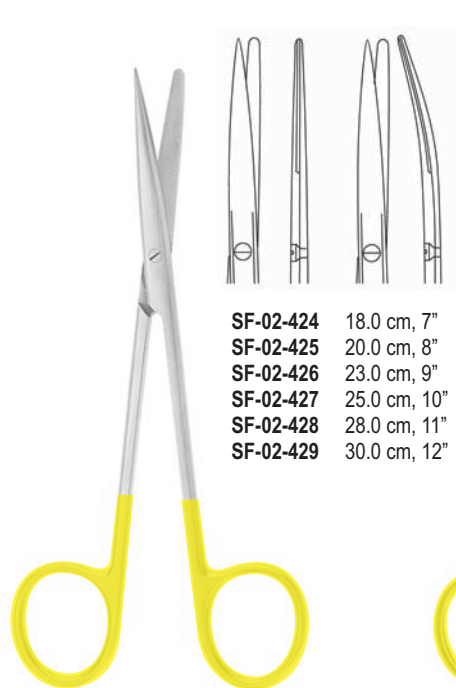

- SF-02-424 18.0 cm, 7"
- SF-02-425 20.0 cm, 8"
- SF-02-426 23.0 cm, 9"
- SF-02-427 25.0 cm, 10"
- SF-02-428 28.0 cm, 11"
- SF-02-429 30.0 cm, 12"

**METZENBAUM**  
SF-02-424 - SF-02-429

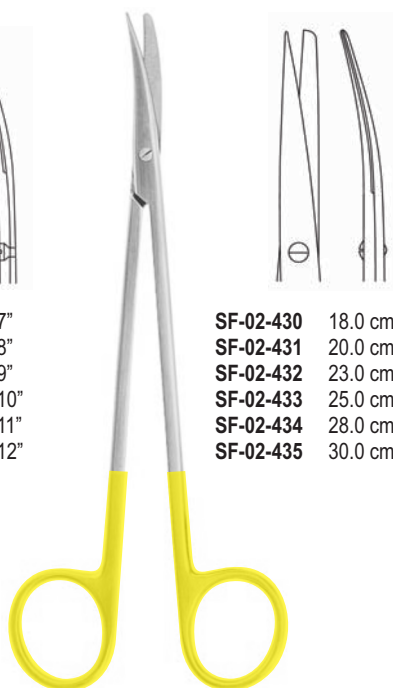

- SF-02-430 18.0 cm, 7"
- SF-02-431 20.0 cm, 8"
- SF-02-432 23.0 cm, 9"
- SF-02-433 25.0 cm, 10"
- SF-02-434 28.0 cm, 11"
- SF-02-435 30.0 cm, 12"

**METZENBAUM**  
SF-02-430 - SF-02-435

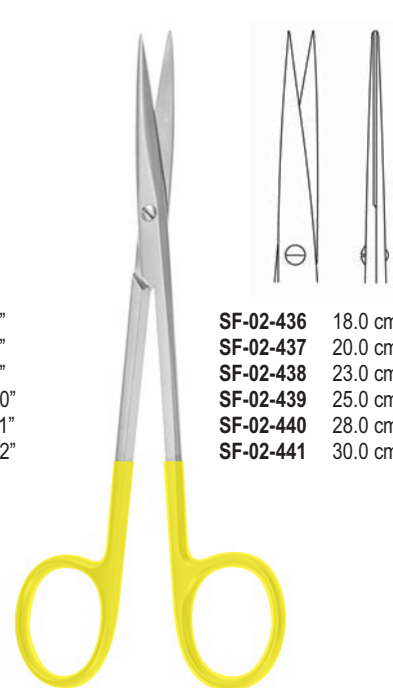

- SF-02-436 18.0 cm, 7"
- SF-02-437 20.0 cm, 8"
- SF-02-438 23.0 cm, 9"
- SF-02-439 25.0 cm, 10"
- SF-02-440 28.0 cm, 11"
- SF-02-441 30.0 cm, 12"

**METZENBAUM**  
SF-02-436 - SF-02-441

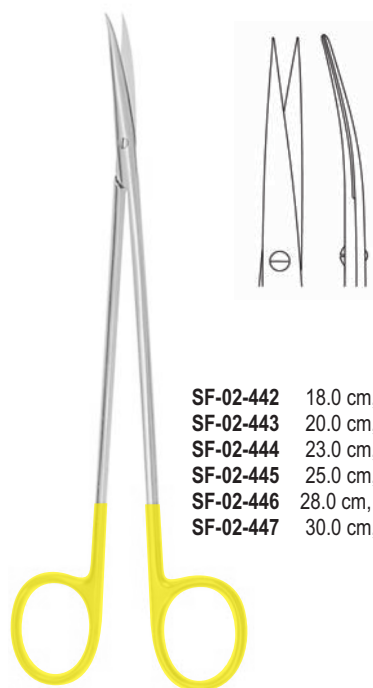

- SF-02-442 18.0 cm, 7"
- SF-02-443 20.0 cm, 8"
- SF-02-444 23.0 cm, 9"
- SF-02-445 25.0 cm, 10"
- SF-02-446 28.0 cm, 11"
- SF-02-447 30.0 cm, 12"

**METZENBAUM**  
SF-02-442 - SF-02-447



- SF-02-448
- SF-02-449

**METZENBAUM-FINO**  
SF-02-448 - SF-02-449  
14.5 cm, 5 3/4"

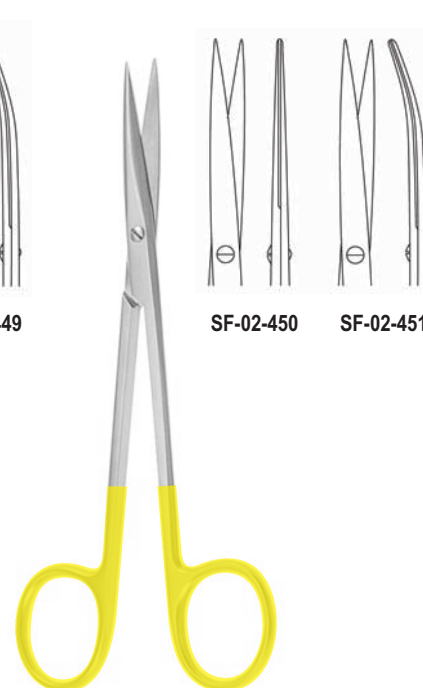

- SF-02-450
- SF-02-451

**METZENBAUM-FINO**  
SF-02-450 - SF-02-451  
14.5 cm, 5 3/4"

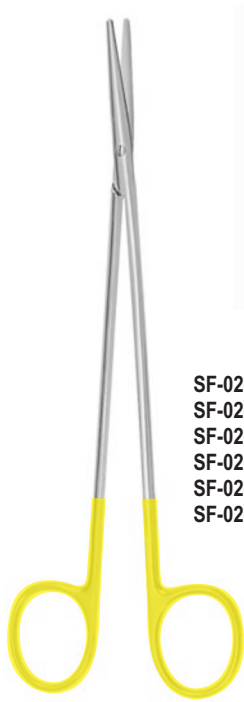

- SF-02-452 18.0 cm, 7"
- SF-02-453 20.0 cm, 8"
- SF-02-454 23.0 cm, 9"
- SF-02-455 25.0 cm, 10"
- SF-02-456 28.0 cm, 11"
- SF-02-457 30.0 cm, 12"

METZENBAUM-FINO  
SF-02-452 - SF-02-457

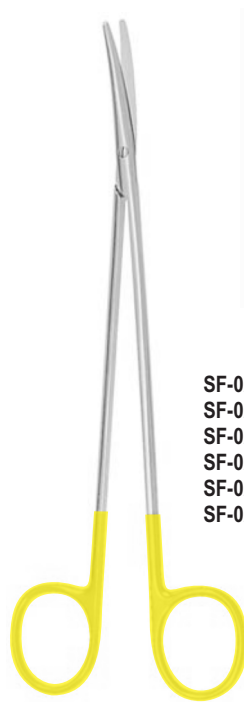
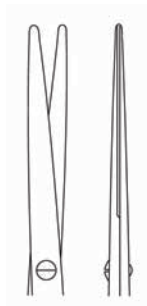

- SF-02-458 18.0 cm, 7"
- SF-02-49 20.0 cm, 8"
- SF-02-460 23.0 cm, 9"
- SF-02-461 25.0 cm, 10"
- SF-02-462 28.0 cm, 11"
- SF-02-463 30.0 cm, 12"

METZENBAUM-FINO  
SF-02-458 - SF-02-463

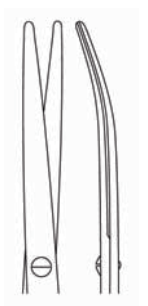

- SF-02-464 18.0 cm, 7"
- SF-02-465 20.0 cm, 8"
- SF-02-466 23.0 cm, 9"
- SF-02-467 25.0 cm, 10"
- SF-02-468 28.0 cm, 11"
- SF-02-469 30.0 cm, 12"

METZENBAUM-FINO  
SF-02-464 - SF-02-469

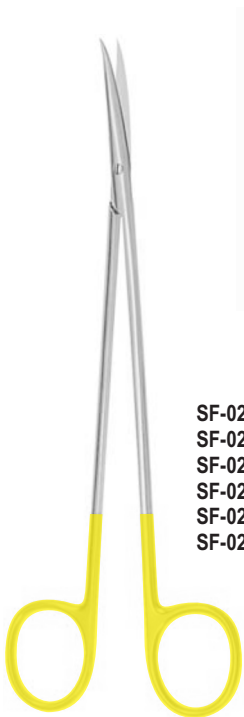

- SF-02-470 18.0 cm, 7"
- SF-02-471 20.0 cm, 8"
- SF-02-472 23.0 cm, 9"
- SF-02-473 25.0 cm, 10"
- SF-02-474 28.0 cm, 11"
- SF-02-475 30.0 cm, 12"

METZENBAUM-FINO  
SF-02-470 - SF-02-475

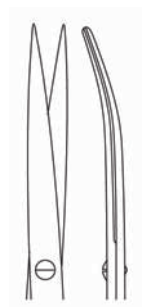

METZENBAUM-LAHEY  
SF-02-476  
14.5 cm, 5½"

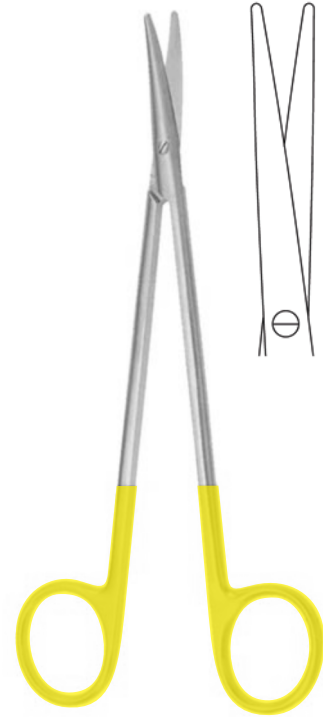
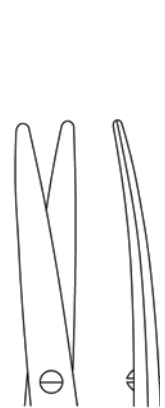

TOENNIS-ADSON  
SF-02-477  
17.0 cm, 6 3/4"



DISSECTING SCISSORS WITH TUNGSTEN CARBIDE EDGES

[www.surgiforce.com](http://www.surgiforce.com)

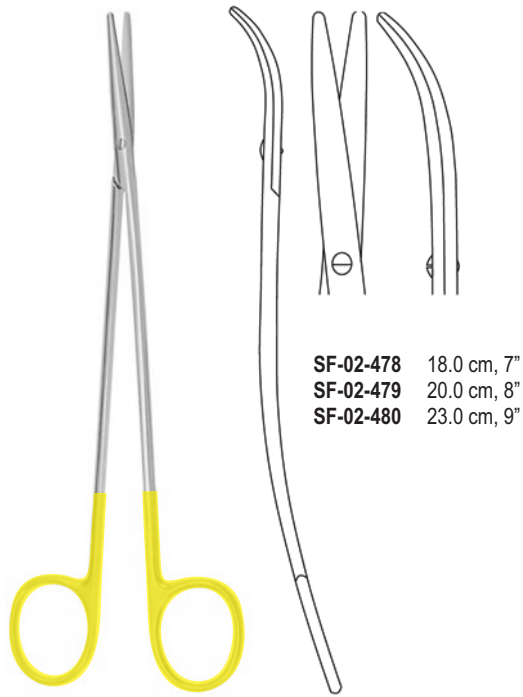

**SF-02-478** 18.0 cm, 7"  
**SF-02-479** 20.0 cm, 8"  
**SF-02-480** 23.0 cm, 9"

**METZENBAUM-FINO**  
**SF-02-478 - SF-02-480**

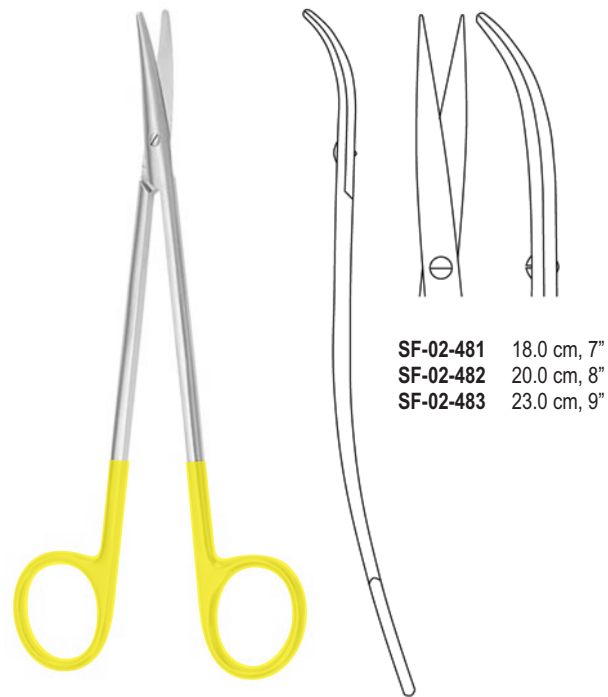

**SF-02-481** 18.0 cm, 7"  
**SF-02-482** 20.0 cm, 8"  
**SF-02-483** 23.0 cm, 9"

**METZENBAUM-FINO**  
**SF-02-481 - SF-02-483**

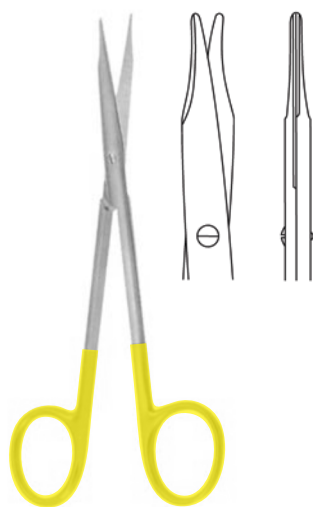

**REYNOLDS**  
**SF-02-484**  
 15.0 cm, 6"

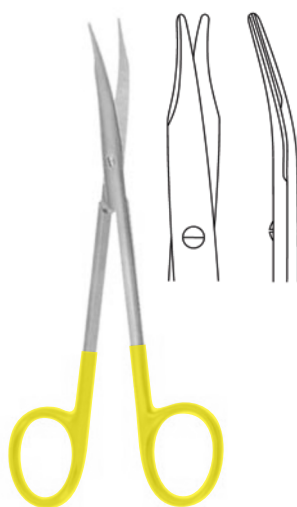

**REYNOLDS**  
**SF-02-485**  
 15.0 cm, 6"



**HYSTEREKTOMY**  
**SF-02-486**  
 25.5 cm, 10"



**HYSTEREKTOMY**  
**SF-02-487**  
 25.5 cm, 9 3/4"



SIMS  
SF-02-488 - SF-02-489

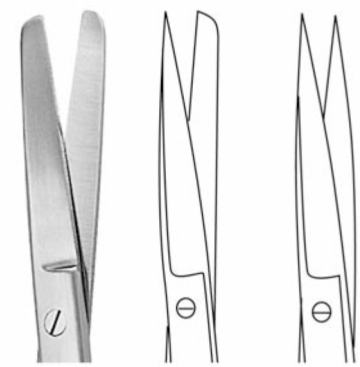

SF-02-488 20.0 cm, 8"  
SF-02-489 23.0 cm, 9"



SIMS  
SF-02-490 - SF-02-491



SF-02-490 20.0 cm, 8"  
SF-02-491 23.0 cm, 9"

VASCULAR SCISSORS WITH TUNGSTEN CARBIDE EDGES

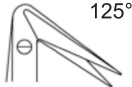

DIETRICH  
SF-02-492  
17.5 cm, 6 5/8"



POTTS DE MARTEL  
SF-02-493  
24.0 cm, 9 1/2"

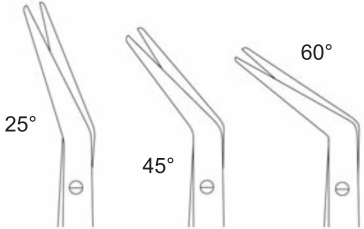

SF-02-494 20.0 cm, 8"  
SF-02-495 23.0 cm, 9"

DE BAKEY  
SF-02-494 - SF-02-495

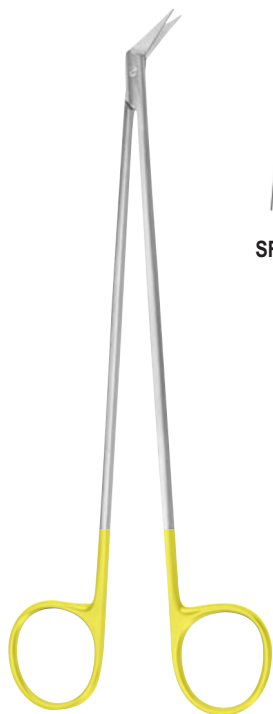

DIETRICH-HEGEMANN  
SF-02-496 - SF-02-500  
18.0 cm, 7"

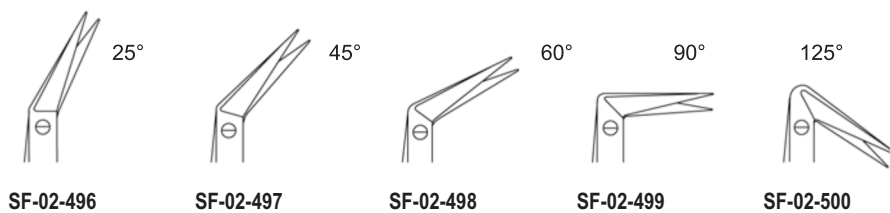

POTTS-SMITH  
SF-02-501 - SF-02-503  
18.0 cm, 7½"

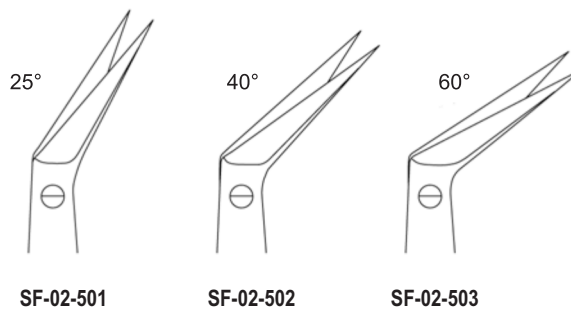



SCISSORS WITH TUNGSTEN CARBIDE EDGES

[www.surgiforce.com](http://www.surgiforce.com)

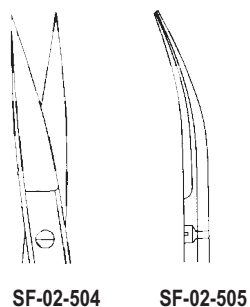
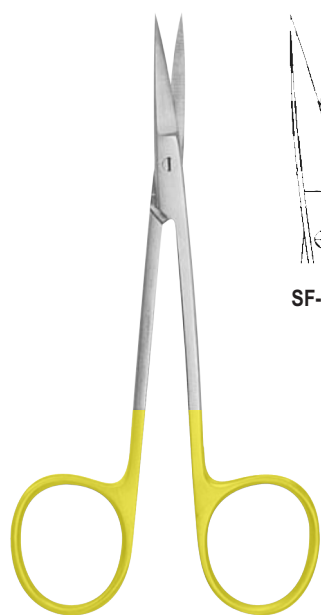

SF-02-504

SF-02-505

IRIS  
SF-02-504 - SF-02-505  
11.5 cm, 4½"

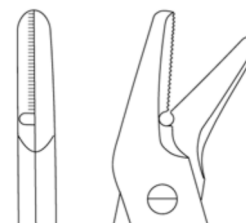
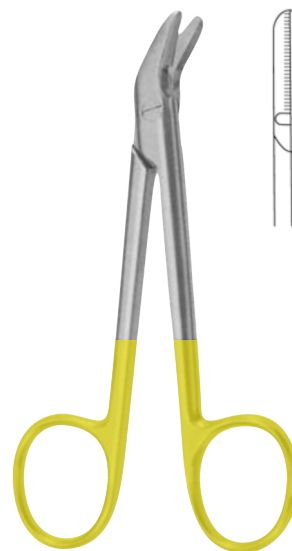

gezahnt  
serrated  
dentada  
dentata

UNIVERSAL  
SF-02-506  
12.0 cm, 4 ¾"

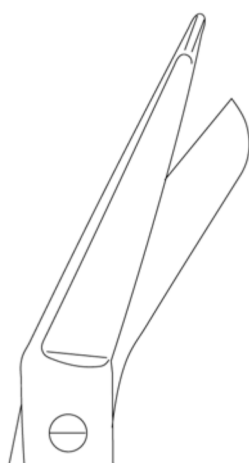

LISTER  
SF-02-507  
18.0 cm, 7"



LISTER  
BC-408  
24.0 cm, 9½"

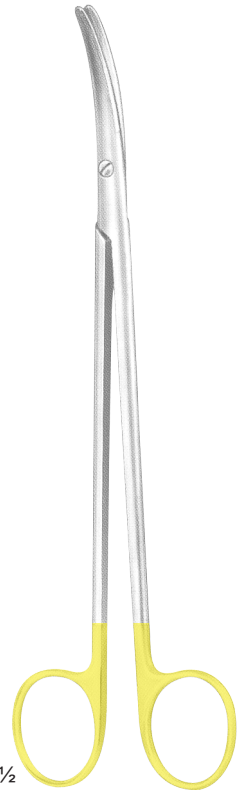

METZENBAUM-THOREK  
SF-02-509 - SF-02-511

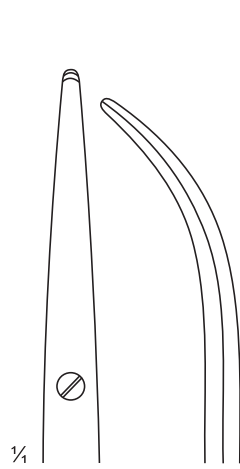

**SF-02-509**  
200 mm

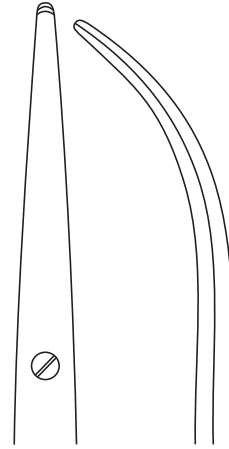

**SF-02-510**  
230 mm

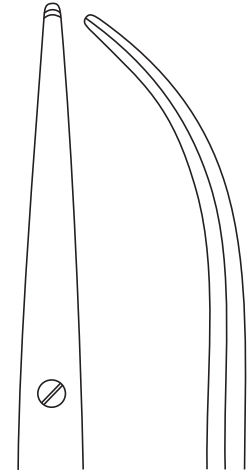

**SF-02-511**  
280 mm

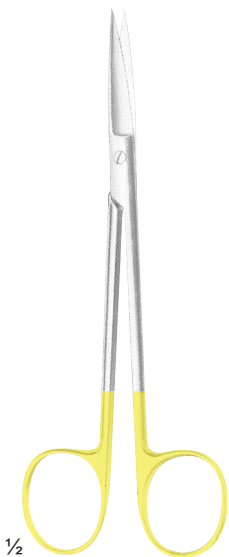

JOSEPH  
SF-02-512 - SF-02-513



**SF-02-512**  
14.5 cm

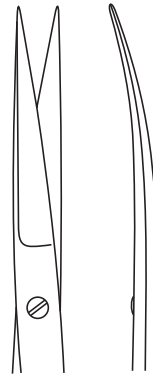

**SF-02-513**  
14.5 cm

DELICATE DISSECTING SCISSORS WITH TUNGSTEN CARBIDE

www.surgiforce.com

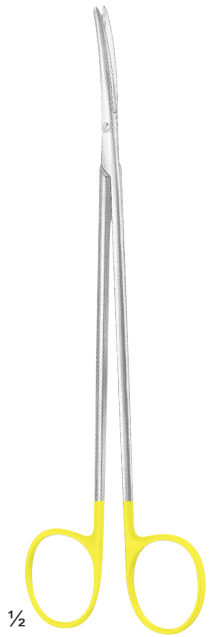

TOENNIS-ADSON  
**SF-02-514**  
175 mm  
slender pattern

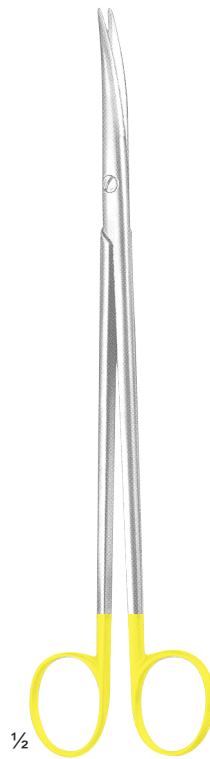

METZENBAUM-FINO  
**SF-02-515 - SF-02-516**  
slender pattern



**SF-02-515**  
205 mm

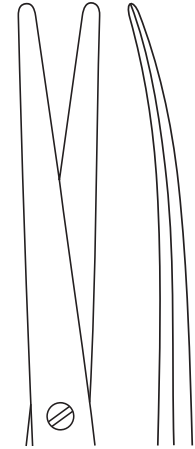

**SF-02-516**  
230 mm

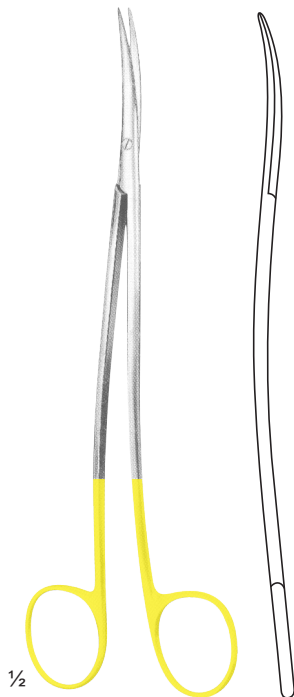

METZENBAUM-FINO  
**SF-02-517 - SF-02-519**  
slender pattern



**SF-02-517**  
180 mm



**SF-02-518**  
205 mm



**SF-02-519**  
230 mm

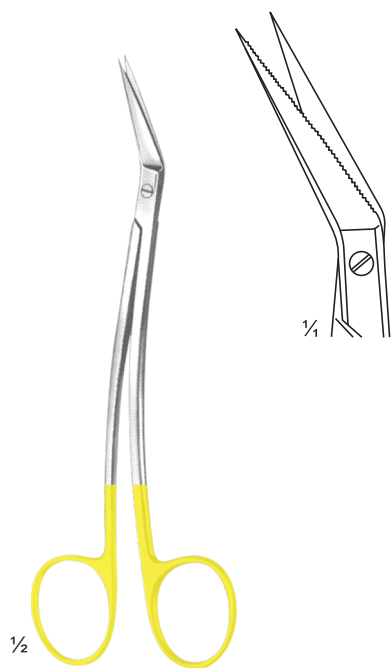

LOCKLIN  
**SF-02-520**  
160 mm  
one toothed cutting edge

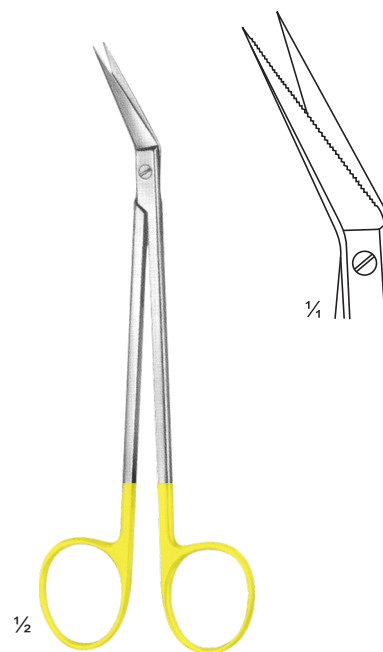

LOCKLIN  
**SF-02-521**  
160 mm  
one toothed cutting edge

SUPER-CUT SCISSORS

[www.surgiforce.com](http://www.surgiforce.com)



MAYO  
SF-02-522 - SF-02-523  
17.0 cm, 6 3/4"

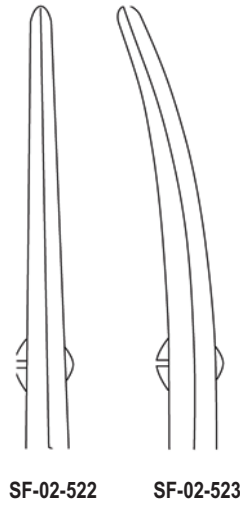

SF-02-522 SF-02-523

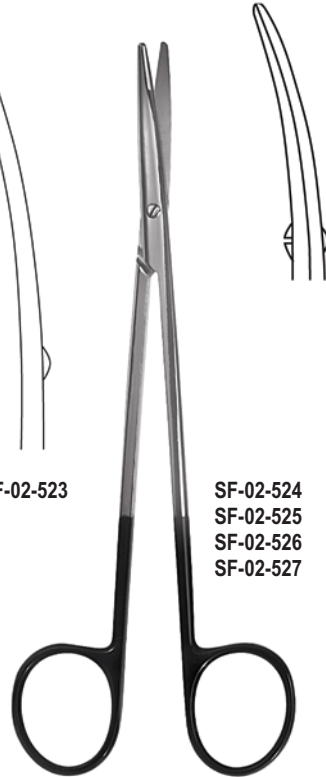

METZENBAUM  
SF-02-524 - SF-02-527

SF-02-524 14.5 cm, 5 3/4"  
SF-02-525 18.0 cm, 7"  
SF-02-526 20.0 cm, 8"  
SF-02-527 23.0 cm, 9"

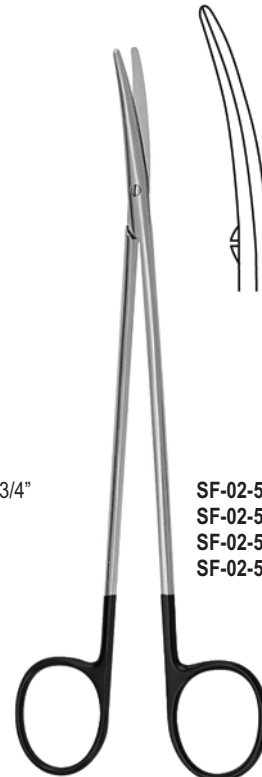

METZENBAUM-FINO  
SF-02-528 - SF-02-531

SF-02-528 14.5 cm, 5 3/4"  
SF-02-529 18.0 cm, 7"  
SF-02-530 20.0 cm, 8"  
SF-02-531 23.0 cm, 9"



KAYE FACE LIFT  
SF-02-532 - SF-02-533

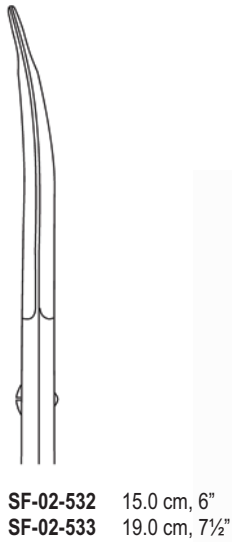

SF-02-532 15.0 cm, 6"  
SF-02-533 19.0 cm, 7 1/2"



JABALEY  
SF-02-534  
13.0 cm, 5"



ENDARTERECTOMY  
SF-02-535  
18.0 cm, 7"



TOENNIS-ADSON  
SF-02-536  
17.0 cm, 6 3/4"



SF-02-537

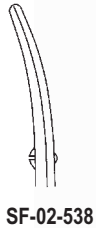

SF-02-538

**STRABISMUS**  
SF-02-537 - SF-02-538  
11.5 cm, 4 1/2"



**JAMISON**  
SF-02-539 15.0 cm, 6"  
SF-02-540 18.0 cm, 7"



**REYNOLDS**  
SF-02-541  
12.5 cm, 5"



**BABY-METZENBAUM**  
SF-02-542 11.0 cm, 4 3/8"  
SF-02-543 14.5 cm, 5 3/4"



**IRIS**  
SF-02-544  
11.0 cm, 4 3/8"



**IRIS**  
SF-02-545  
11.0 cm, 4 3/8"



**STEVENS TENOTOMY**  
SF-02-546  
11.0 cm, 4 3/8"



**STEVENS TENOTOMY**  
SF-02-547  
11.0 cm, 4 3/8"



PAR TYPE  
**SF-02-548**  
12.0 cm, 4 3/4"



PAR TYPE  
**SF-02-549**  
12.0 cm, 4 3/4"



POTTS  
**SF-02-550 - SF-02-552**  
19.0 cm, 7 1/2"

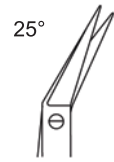

**SF-02-550**

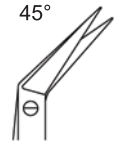

**SF-02-551**

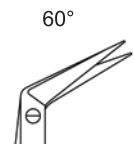

**SF-02-552**

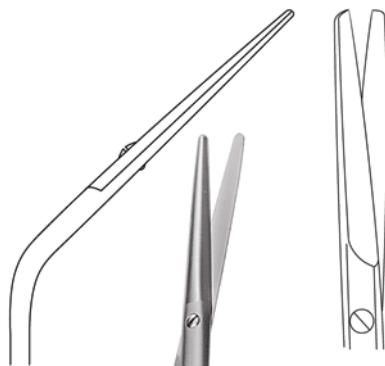

**SF-02-553**  
14.5 cm, 5 3/4"

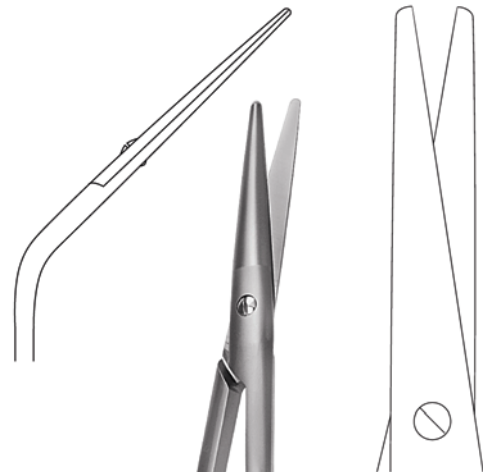

COTTLE  
**SF-02-554**  
16.5 cm, 6 1/2"

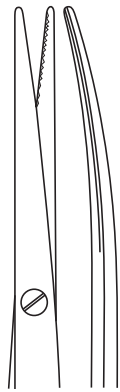

**SF-02-555**  
14.5 cm



**SF-02-556**  
18 cm



**SF-02-557**  
20.5 cm

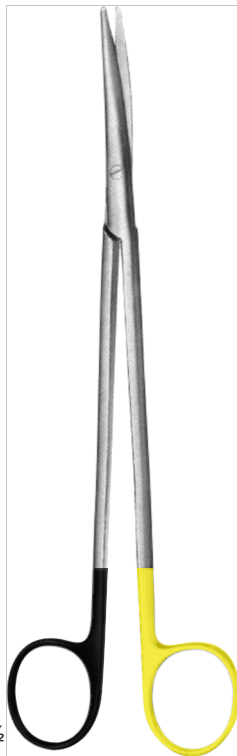

1/2

LIGATURE SCISSORS  
**SF-02-555 - SF-02-560**  
for synthetic suture material,  
one toothed cutting edge



1/4

**SF-02-558**  
23 cm



**SF-02-559**  
25 cm



**SF-02-560**  
30 cm





LIGATURE SCISSORS  
**SF-02-561 - SF-02-563**  
for synthetic suture material,  
one toothed cutting edge



**SF-02-561**  
14.5 cm

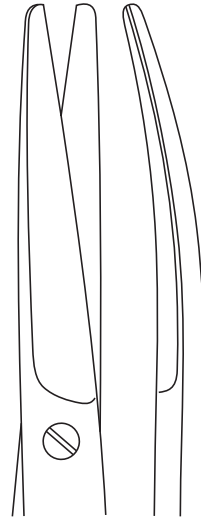

**SF-02-562**  
17 cm



**SF-02-563**  
23 cm



IRIS  
**SF-02-564**  
11.5 cm





**SF-02-565**  
18 cm



**SF-02-566**  
20 cm



**SF-02-567**  
23 cm



**SF-02-568**  
26 cm



**SF-02-569**  
28.5 cm



**SF-02-570**  
31 cm

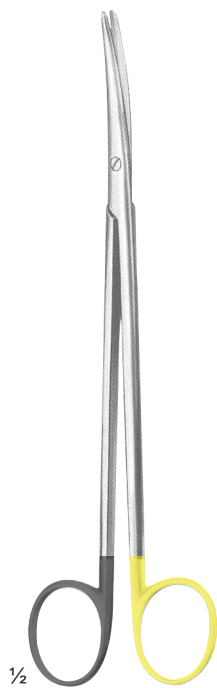

**METZENBAUM**  
**SF-02-565 - SF-02-570**



# Surgiforce Instruments



Opposite Surgical Association,  
Malkay Kalan, Marala Road,  
Sialkot-51050 Pakistan.



+92 523 559131



info@surgiforce.com  
sales@surgiforce.com



www.surgiforce.com



## Our Certifications:

ISO 9001	ISO 7151
CE Certified	ISO 17664:2004
EN 13485:2012	ISO 13402
ISO 7153-1	ISO 15223

