

## Page 1-21

- Percussion Hammers & Aesthesiometers
- Tongue Depressors
- Diagnostic Sets
- Examination & Measuring Instruments
- Dissecting Knives
- Scalpels, Tenotomes & Resection Knives



**SF-01-101**  
TROEMNER  
245 mm

1/2



**SF-01-102**  
DEJERINE  
200 mm

1/2



**SF-01-103**  
DEJERINE  
With Needle  
210 mm

1/2

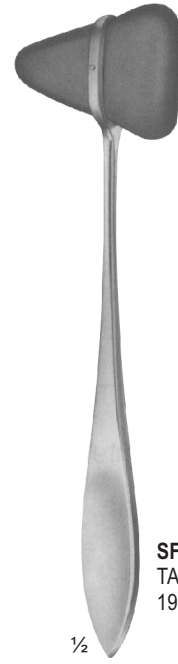

**SF-01-104**  
TAYLOR  
195 mm

1/2

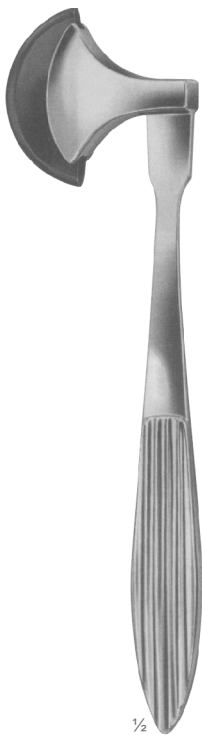

**SF-01-105**  
BERLINER  
200 mm

1/2

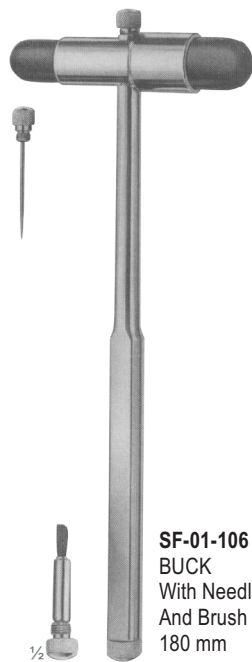

**SF-01-106**  
BUCK  
With Needle  
And Brush  
180 mm

1/2

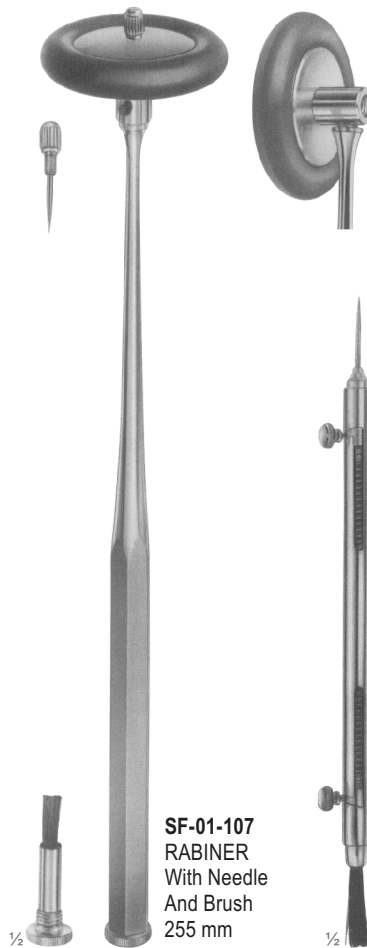

**SF-01-107**  
RABINER  
With Needle  
And Brush  
255 mm

1/2



**SF-01-108**  
ALY  
190 mm

1/2

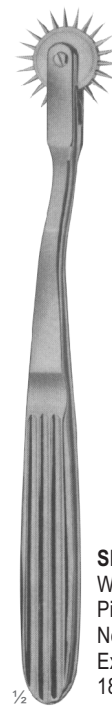

**SF-01-109**  
WARTENBERG  
Pinwheel For  
Neurological  
Examination  
185 mm

1/2

TONGUE DEPRESSORS

[www.surgiforce.com](http://www.surgiforce.com)

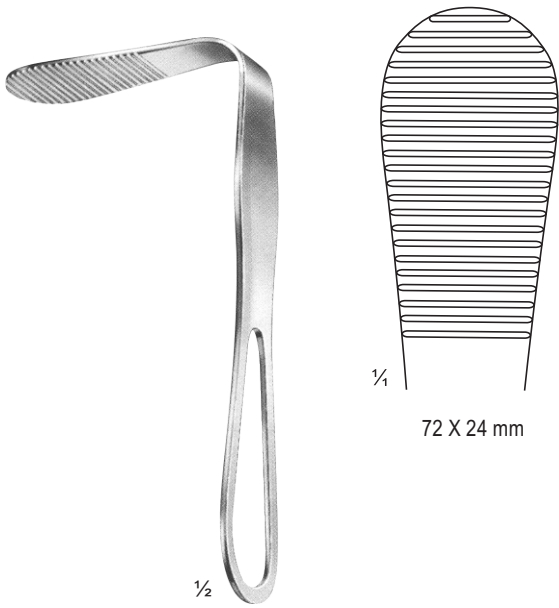

**SF-01-110**  
HARTMANN  
150 mm

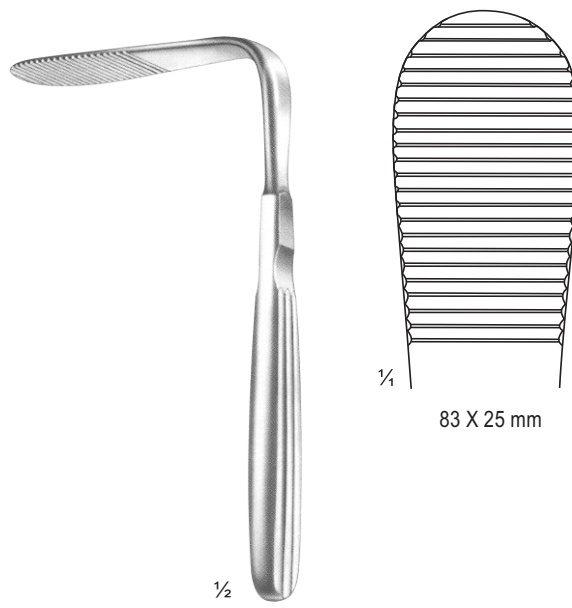

**SF-01-111**  
TOBOLD  
150 mm



**SF-01-112**  
TOBOLD  
160 mm

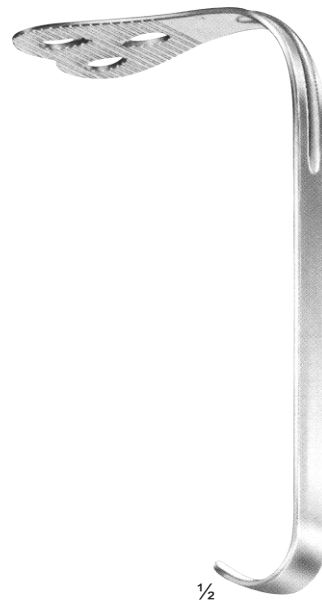

**SF-01-113 - SF-01-114**  
WIEDER

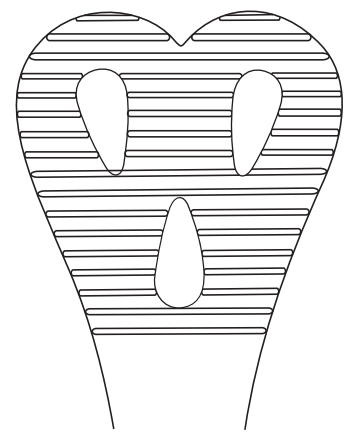

**SF-01-113**  
15 cm  
43 mm

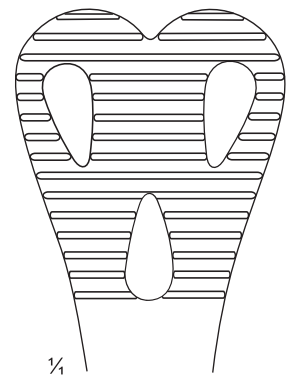

**SF-01-114**  
140 mm  
36 mm

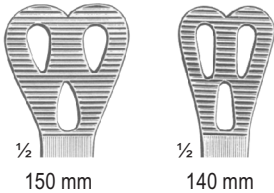
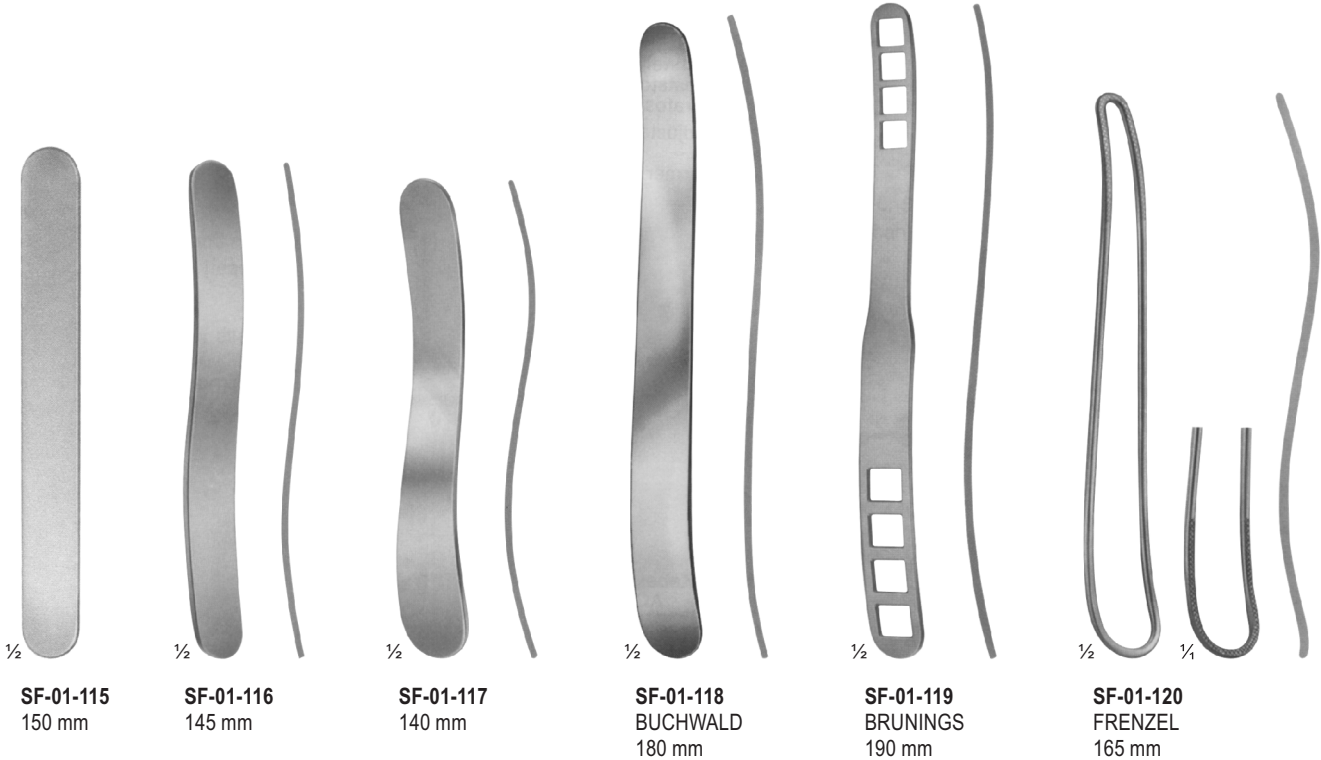



**SF-01-126**  
HEISTER  
Mouth Gag  
Size: 130 mm

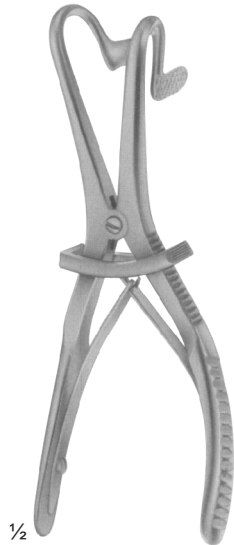

**SF-01-127**  
FERGUSON-ACKLAND  
Mouth Gag  
Size: 145 mm



**SF-01-128**  
DENHARDT  
Mouth Gag With Silicon  
Inserts, Interchangeable  
Size: 125 mm



**SF-01-129**  
ROSER KONIG  
Mouth Gag  
Size: 160 mm,  
185 mm

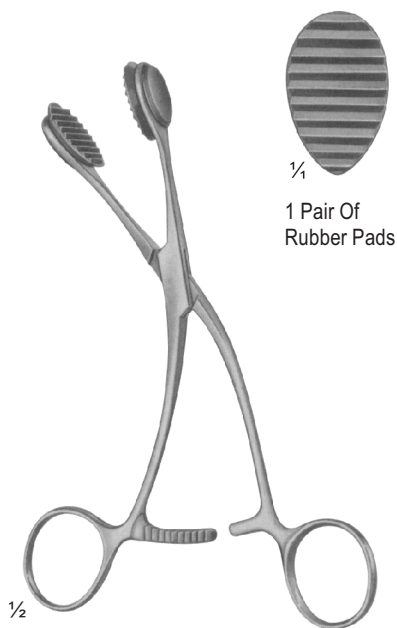

**SF-01-130**  
YOUNG  
165 mm

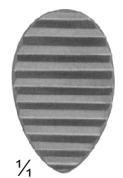

$\frac{1}{4}$   
1 Pair Of  
Rubber Pads

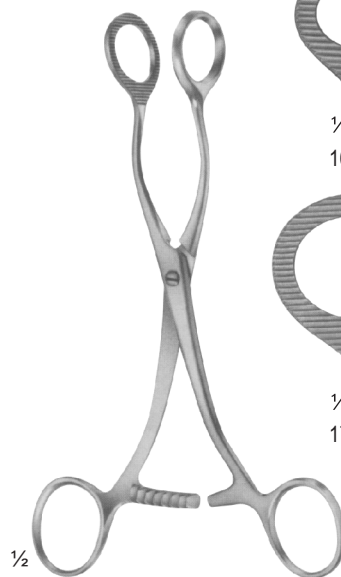

**SF-01-131**  
COLLIN  
160 mm, 170 mm



$\frac{1}{4}$   
160 mm



$\frac{1}{4}$   
170 mm

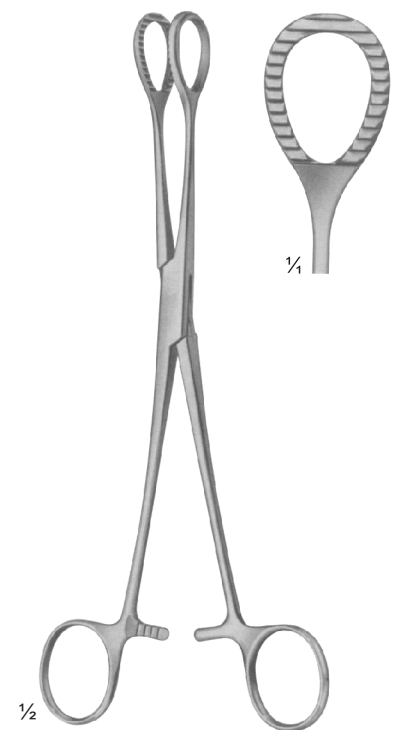

**SF-01-132**  
HEYWOOD-SMITH modif.  
215 mm



**SF-01-133**  
Infants  
150 mm



**SF-01-134**  
Children  
200 mm



**SF-01-135**  
Adults  
250 mm



$\frac{1}{2}$  **SF-01-133 - SF-01-135**  
MAGILL



**SF-01-136**  
TUBING CLAMP  
7", 8"  
180 mm, 200 mm

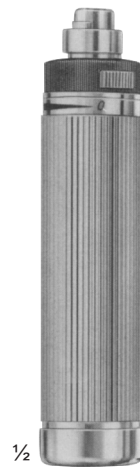

$\frac{1}{2}$  **SF-01-137**  
Medium battery handle  
only, 25 mm diam.



**SF-01-138**  
Spare bulb  
2.7 volt, for  
autosopes



**SF-01-139**  
Spare bulb  
2.6 volt, for  
ophthalmoscopes



**SF-01-140**  
Otoscope Set, Consists Of  
Battery Handle Without Batteries,  
3 Ear Specula, 1 Bulb In Velvet Lined Case



**SF-01-141**  
Diagnostic Set, Otoscope With Three Specula,  
Nasal Speculam, Lamp Holder, Two Laryngeal  
Mirrors, Tongue Blade Holder



**SF-01-142**  
MILLER  
Laryngoscope Set, Consists Of Battery Handle  
( Without Battery ) With Four Miller  
Laryngoscope Blades

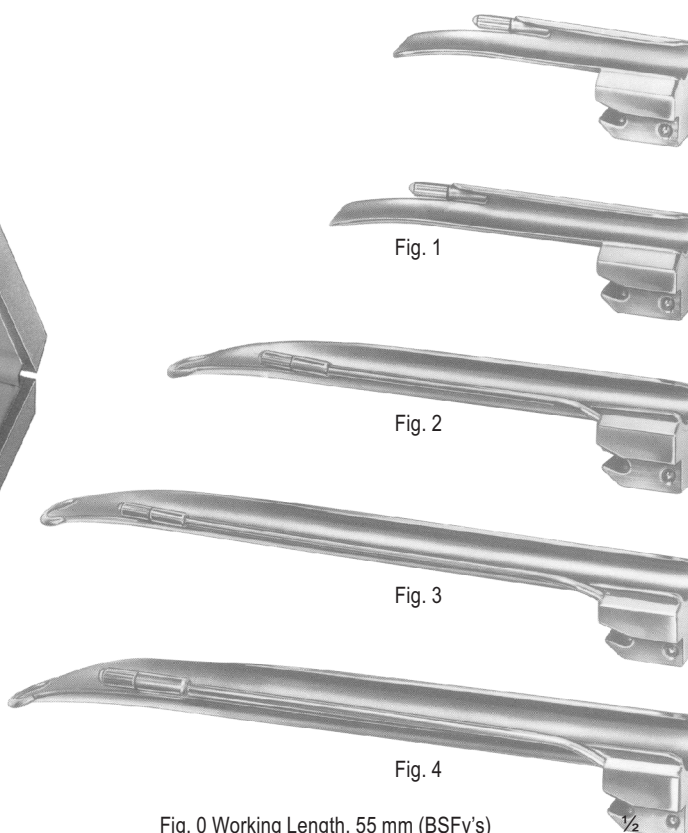

Fig. 0 Working Length, 55 mm (BSFy's)  
Fig. 1 Working Length, 80 mm (Children's)  
Fig. 2 Working Length, 130 mm (Adolescent's)  
Fig. 3 Working Length, 170 mm (Women's)  
Fig. 4 Working Length, 180 mm (Men's)



**SF-01-143**  
GUEDEL-NEGUS  
Laryngoscope Set, Consists Of Battery Handle  
( Without Battery ) With Four Miller  
Laryngoscope Blades

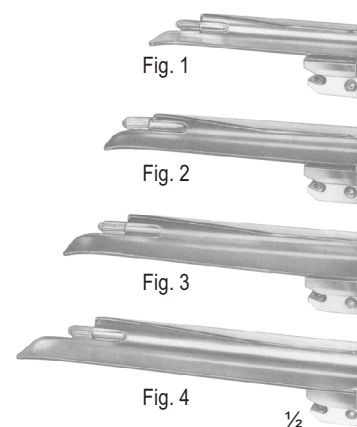

Fig. 1 Working Length, 70 mm (Children's)  
Fig. 2 Working Length, 90 mm (Adolescent's)  
Fig. 3 Working Length, 110 mm (Women's)  
Fig. 4 Working Length, 135 mm (Men's)



**SF-01-144**  
McIntosh  
Laryngoscope Set, Consists Of Battery Handle ( Without Battery ) With Three McIntosh Blades, Fig. 1, Fig. 2, Fig. 3

1/3

**SF-01-145**  
McIntosh  
Laryngoscope Set, Consists Of Battery Handle ( Without Battery ) With Five McIntosh Blades, Fig. 1, Fig. 2, Fig. 3, Fig. 4, Fig. 5

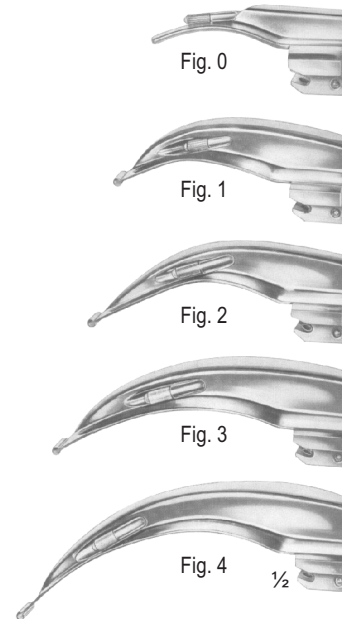
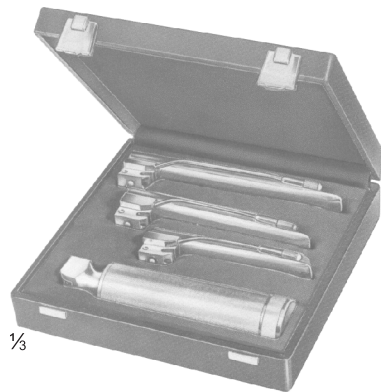

Fig. 0 Working Length, 55 mm (BSFy's)  
Fig. 1 Working Length, 75 mm (Children's)  
Fig. 2 Working Length, 90 mm (Adolescent's)  
Fig. 3 Working Length, 110 mm (Women's)  
Fig. 4 Working Length, 135 mm (Men's)



**SF-01-146**  
6GER  
Laryngoscope Set, Consists Of Battery Handle ( Without Battery ) With Three Foregger Blades, Fig. 1, Fig. 2, Fig. 3,

1/3

**SF-01-147**  
FOREGGER  
Laryngoscope Set, Consists Of Battery Handle ( Without Battery ) With Five Foregger Blades, Fig. 1, Fig. 2, Fig. 3, Fig. 4, Fig. 5

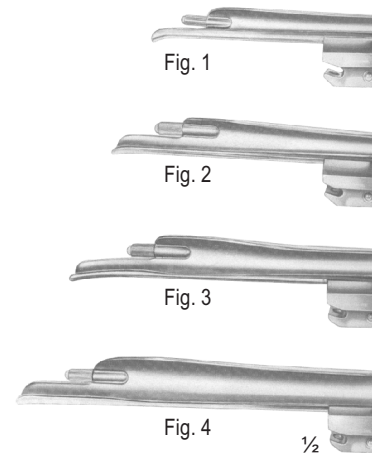

Fig. 1 Working Length, 70 mm (Children's)  
Fig. 2 Working Length, 90 mm (Adolescent's)  
Fig. 3 Working Length, 110 mm (Women's)  
Fig. 4 Working Length, 135 mm (Men's)



**SF-01-148**  
Fiber Optic  
Battery Handle

1/2



**SF-01-149**  
Fiber Optic  
Battery Handle

1/2



**SF-01-150**  
Replacement Lamp  
( Krypton ) 2.5 V

1/4



**SF-01-151**  
Replacement Lamp  
( Halogen ) 2.5 V

1/4





**SF-01-152**  
Boley



Metal: **SF-01-153**  
Wax : **SF-01-154**  
Double Side Marking  
Iwanson

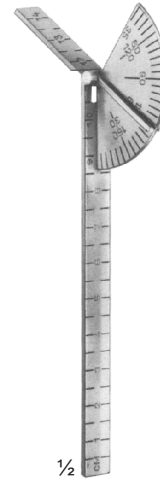

**SF-01-155**  
CAROLL  
140 mm



**SF-01-156**  
TOWNLEY  
100 mm

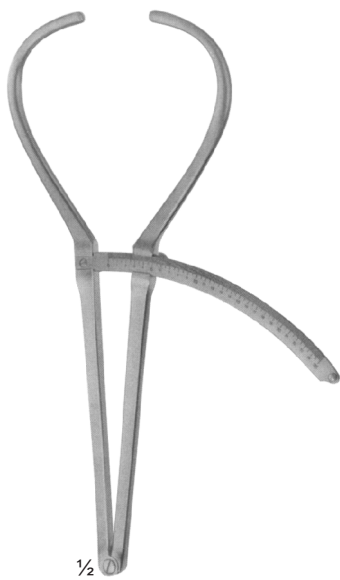

**SF-01-157**  
BERTILLON  
Caliper For Measuring The Head  
320 mm

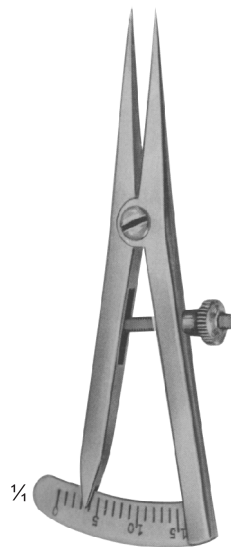

**SF-01-158**  
CASTROVIEJO  
Caliper

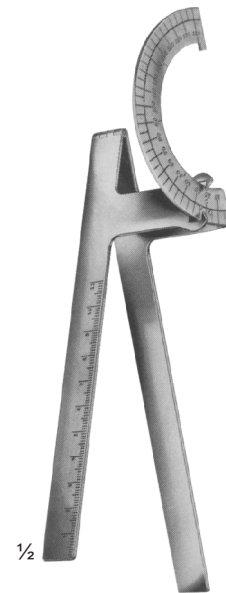

**SF-01-159**  
MOLTGEN  
Goniometer

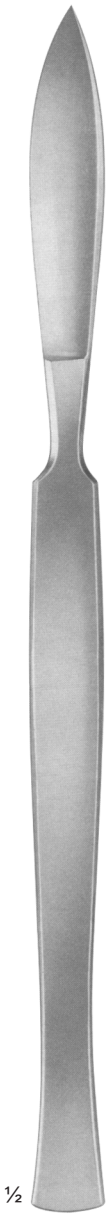

SF-01-160 - SF-01-169  
Fig. 1 - 10



SF-01-160  
Fig. 1



SF-01-161  
Fig. 2



SF-01-162  
Fig. 3



SF-01-163  
Fig. 4



SF-01-164  
Fig. 5



SF-01-165  
Fig. 6



SF-01-166  
Fig. 7



SF-01-167  
Fig. 8



SF-01-168  
Fig. 9



SF-01-169  
Fig. 10

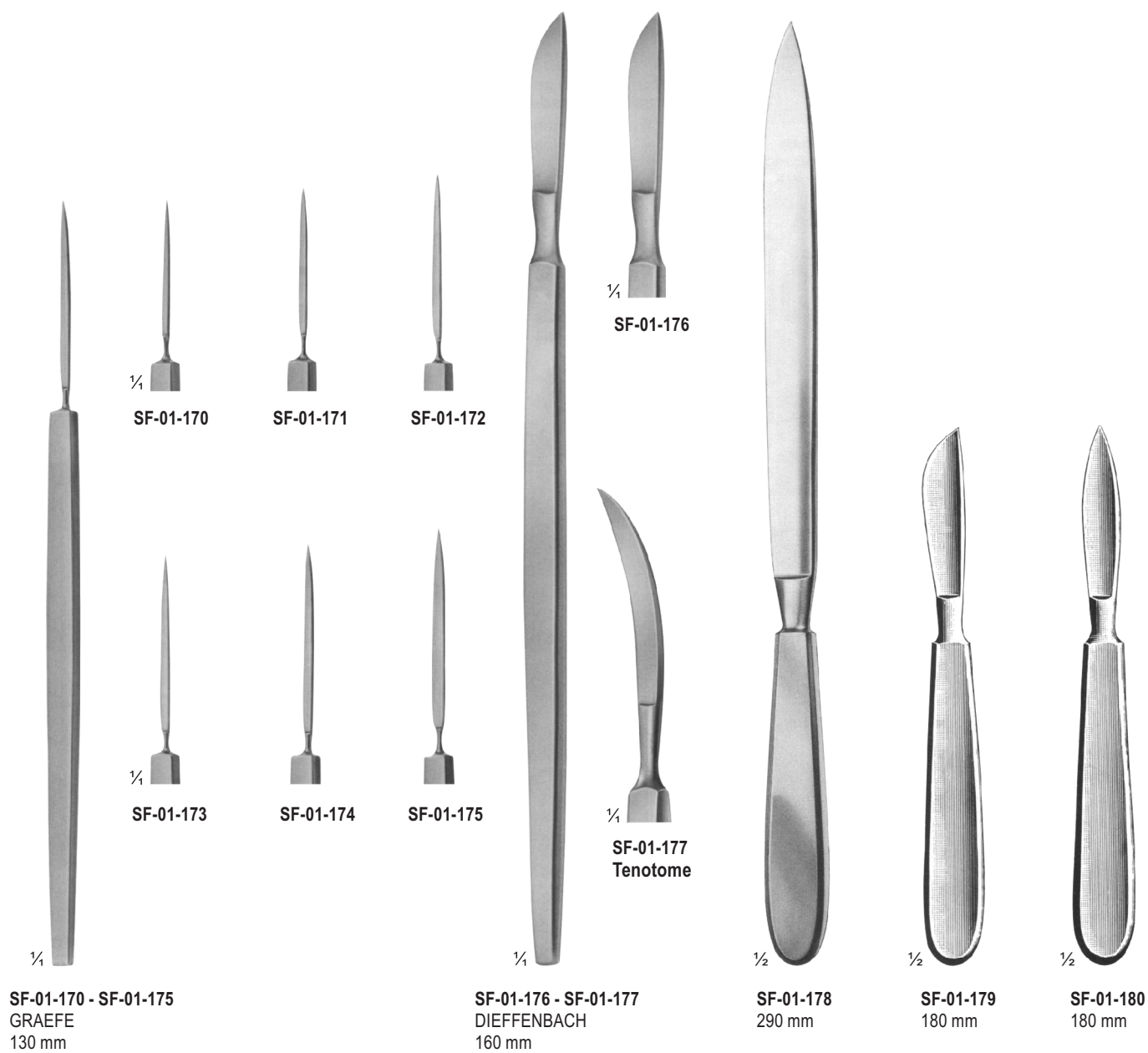

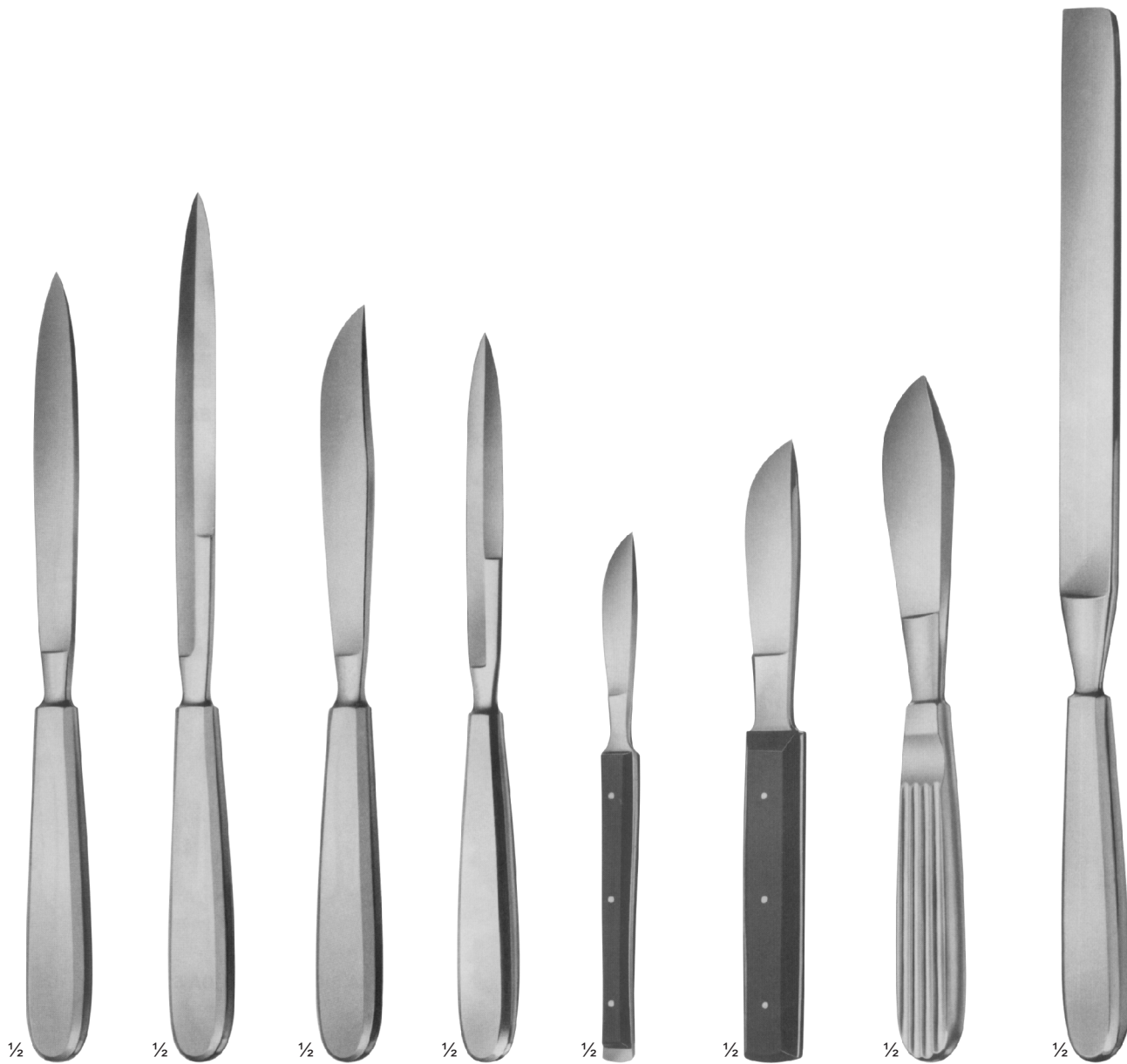

**SF-01-181**  
130 mm  
**SF-01-182**  
160 mm  
**SF-01-183**  
190 mm  
**SF-01-184**  
200 mm

Blade Length  
Amputating Knives

**SF-01-185**  
CATLIN  
160 mm  
Blade Length  
Amputating  
Knives

**SF-01-186**  
LANGENBECK  
120 mm  
Blade Length  
Flap Knives

**SF-01-187**  
110 mm  
Blade Length  
Interosseous  
Knives

**SF-01-188**  
55 mm  
Blade Length  
With Raspatory,  
Wooden Handle

**SF-01-189**  
70 mm  
Blade Length  
Wooden Handle

**SF-01-190**  
80 mm  
Blade Length  
Metal Handle

**SF-01-191**  
195 mm  
Blade Length  
Metal Handle



**SF-01-192**  
AYRE  
235 mm  
Cone Knife

**SF-01-193**  
230 mm  
Cone Knife

**SF-01-194**  
SEGOND  
270 mm  
Myomatome

**SF-01-195**  
OLIVECRONA  
205 mm  
Trigeminal  
Knife

**SF-01-196**  
230 mm  
Trigeminal  
Knife

**SF-01-197**  
FOWLER  
200 mm  
Tonsil Knife

**SF-01-198**  
SFRAHAM  
215 mm  
Tonsil Knife

**SF-01-199**  
BRUNINGS  
215 mm  
Tonsil Knife

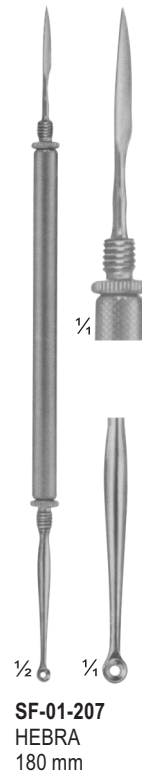
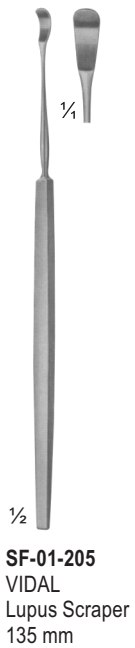
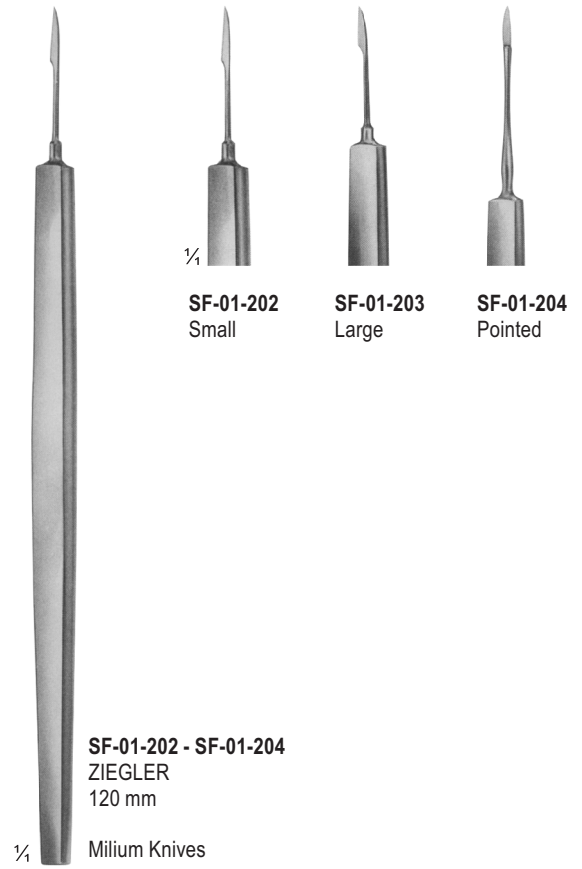
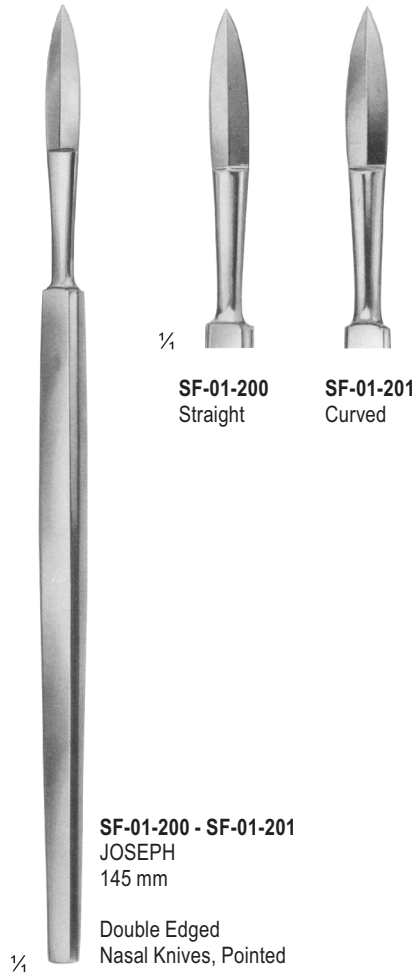



**SF-01-209**  
STANDARD  
No. 4  
Solid

**SF-01-210**  
Double Handle  
No. 4 + No. 3  
Solid

**SF-01-211**  
No. 4 L  
Straight  
Solid

**SF-01-212**  
No. 4 L  
Solid Angled

**SF-01-213**  
COLLIN  
No. 8  
Hollow

**SF-01-214**  
COLLIN  
No. 9  
Hollow

**SF-01-215**  
Plastic



SF-01-216  
STANDARD  
No. 3  
Solid



SF-01-217  
No. 3  
Solid

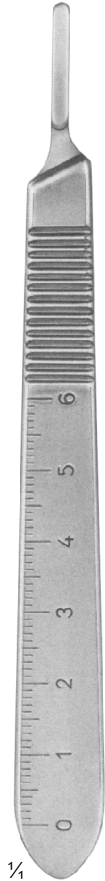

SF-01-218  
No. 3  
Solid

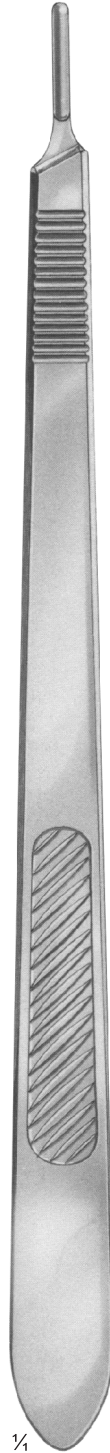

SF-01-219  
No. 3 L  
Straight  
Solid

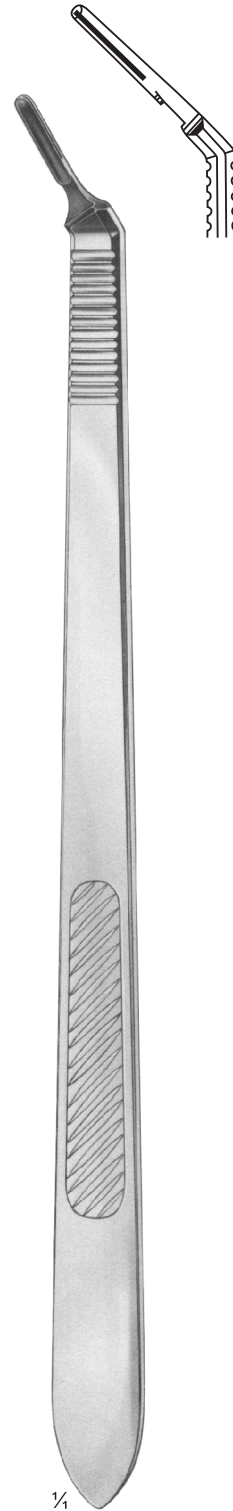

SF-01-220  
No. 3 L  
Angled  
Solid





**SF-01-221**  
No. 7  
Solid



**SF-01-222**  
No. 7 K  
Solid

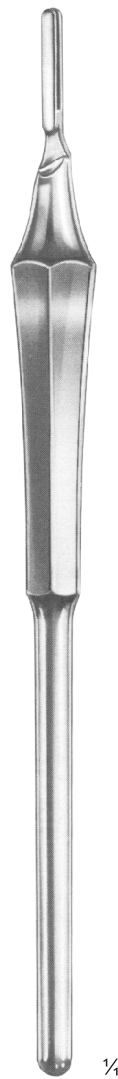

**SF-01-223**  
Hollow-Round



**SF-01-224**  
No. 3  
Straight  
Solid

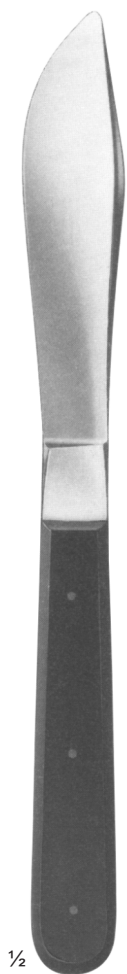

**SF-01-225**  
25.5 cm



**SF-01-226**  
VIRCHOW



**SF-01-227 - SF-01-229**  
VIRCHOW

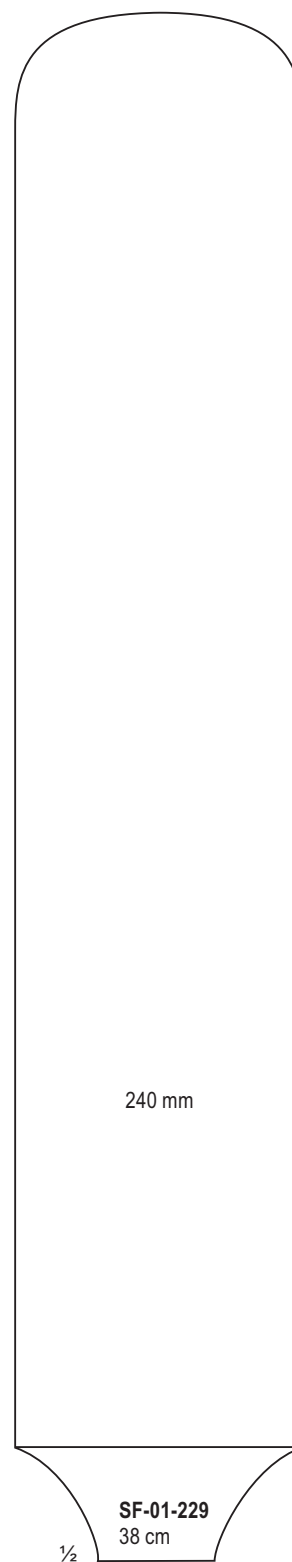
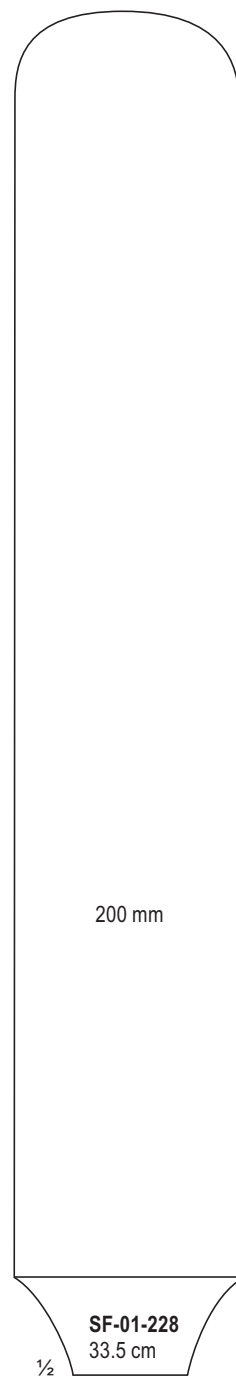
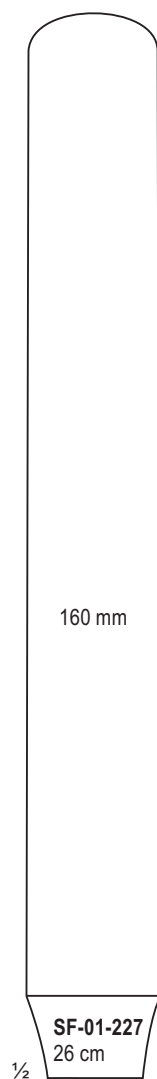



**SF-01-230**  
TROUTMAN-CHRIS  
9 cm



**SF-01-231**  
TROUTMAN-CHRIS  
9 cm



**SF-01-232**  
11 cm

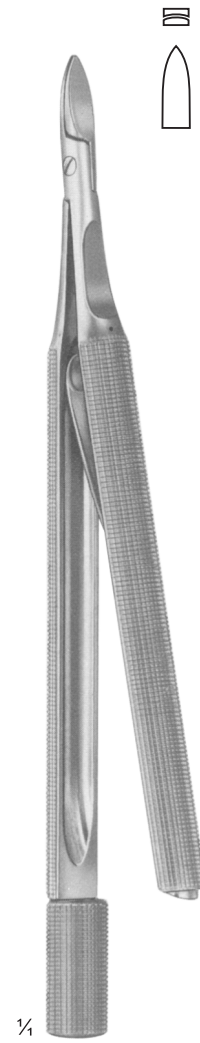

**SF-01-233**  
CASTROVIEJO  
13 cm



**SF-01-234**  
18.5 cm



HUMBY  
SF-01-235

HUMBY  
SF-01-235  
32 cm

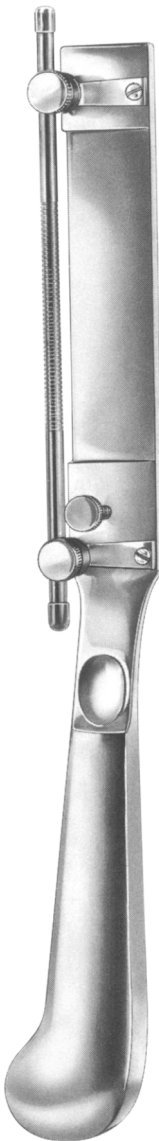

SCHINK  
SF-01-236

SF-01-236  
SCHINK  
30 cm



SF-01-237  
SILVER  
19.5 cm



SF-138  
PARKER



SF-139

9.5 cm

11 cm



SF-140  
COBBETT



SF-141  
BRAITHWATTE



Spare Blade



SF-142  
HUMBY  
35 cm



SF-143  
WATSON  
30 cm



# Surgiforce Instruments



Opposite Surgical Association,  
Malkay Kalan, Marala Road,  
Sialkot-51050 Pakistan.



+92 523 559131



info@surgiforce.com  
sales@surgiforce.com



www.surgiforce.com



## Our Certifications:

ISO 9001

CE Certified

EN 13485:2012

ISO 7153-1

ISO 7151

ISO 17664:2004

ISO 13402

ISO 15223



No.3012922148