

# Surgiforce Instruments



## **SURGICAL** instruments Catalogue

[www.surgiforce.com](http://www.surgiforce.com)

# Company Profile

We at **SURGIFORCE INSTRUMENTS** welcome you to the world of reliable quality in the products where it matters the most, to the world of precision, where lack of it could be a matter of life and death.

**SURGIFORCE INSTRUMENTS** is an industry leader in manufacturing and providing worldwide solutions for SURGICAL / DENTAL / DIAGNOSTIC & HOLLOW WARE instruments.

Our Professionals continually strive to satisfy your technical and clinical needs of surgical instruments. We maintain a team work environment throughout the company by placing experienced members on critical manufacturing processes in instrument craftsmanship with state-of-the-art precision manufacturing equipments and the latest technologies to achieve the highest possible results.

Our instruments range from precision micro handheld surgical instruments(including forceps, clamps, scissors, needle holders, cutting and clamping devices) used in general surgery, ophthalmic, neurosurgical, ENT and cardiovascular specialties to macro instruments used in spinal, orthopedic and other surgical areas.

**SURGIFORCE INSTRUMENTS** holds worldwide recognized certifications such as:

ISO 9001

CE Certified

EN 13485:2012

ISO 7153-1

ISO 7151

ISO 17664:2004

ISO 13402

ISO 15223



Which ensures our clientage that they are in best hands when it comes to quality of the instruments as well as their compliance with the international standards.

Our Quality policy ensures that every instrument is manufactured to its highest quality by maintaining quality checks at every stage, as it is our belief that our success depends on establishing enduring relationships with our customers and consistently producing high quality products that meet their demanding standards and timetables.

---

## Production

### View



# TABLE OF CONTENTS

Scissors  
1-4

---

Needle Holders  
5-6

---

Tissue, Dissecting & Dressing Forceps  
7-8

---

Forceps  
9-10

---

Scalpel Handle  
11

---

Cardiovascular & Thoracic Instruments  
12

---

Retractors  
13-14

---

Orthopedic Instruments  
15-16

---

Suction Tubes  
17

---

ENT Instruments  
18-19

---

OB/GYN Instruments  
20

---

Ophthalmic Instruments  
21-22

---

Micro Instruments  
23

---

Tischler Biopsy Punches  
24

---

Retractors & Forceps  
25

---

Curettes & Hooks  
26

---

Laryngoscope Blades  
27

---

Fiberoptic Handles  
28

---

Otosopes, Ophthalmoscope  
& Dermatoscope  
29

---

Holloware & Instruments Trays  
30-31

---



Scissors are available with & without Tungsten Carbide tips



**Best Seller**

Sharp / Blunt Operating Scissor  
Straight / Curved  
Length: 5" to 10"

SF-1111  
Sharp / Blunt Operating Scissor



Lexer Scissor  
Length: 6", 6.5"  
Straight / Curved

SF-1112  
Lexer Scissor



Sharp / Sharp Operating Scissor  
Straight / Curved  
Length: 5" to 10"

SF-1113  
Sharp / Sharp Operating Scissor



Sims Uterine Scissors  
Length: 8", 9"  
Straight / Curved  
Sharp / Blunt  
Blunt / Blunt

SF-1114  
Sims Uterine Scissors



Mayo Scissor  
Straight / Curved  
Length: 5" to 10"

SF-1115  
Mayo Scissor



Blunt / Blunt Operating Scissor  
Straight / Curved  
Length: 5" to 10"

SF-1116  
Blunt / Blunt Operating Scissor

**Also Available:**  
Mayo - Stile 5.5", 6.75"  
Mayo Harrington 9"  
Straight / Curved  
Mayo Lexer 6.5"

# Dissecting & Delicate Scissors

Scissors are available with & without Tungsten Carbide tips

[www.surgiforce.com](http://www.surgiforce.com)



Steven Scissor  
Sharp and Blunt  
Length: 4" to 6"

**SF-1117**  
Steven Scissor



Angled Iris Scissor  
Length: 11.5 cm

**SF-1118**  
Angled Iris Scissor



Umbilical Bush Scissor  
Length: 5" to 8"

**SF-1119**  
Umbilical Bush Scissor



Braun Episiotomy Scissors  
Length: 5.5" to 8"

**SF-1120**  
Braun Episiotomy Scissors



LaGrange Scissor  
Length: 4", 5"

**SF-1121**  
LaGrange Scissor



Angled Metzenbaum Scissor  
Length: 12 cm

**SF-1122**  
Angled Metzenbaum Scissor

Scissors are available with & without Tungsten Carbide tips

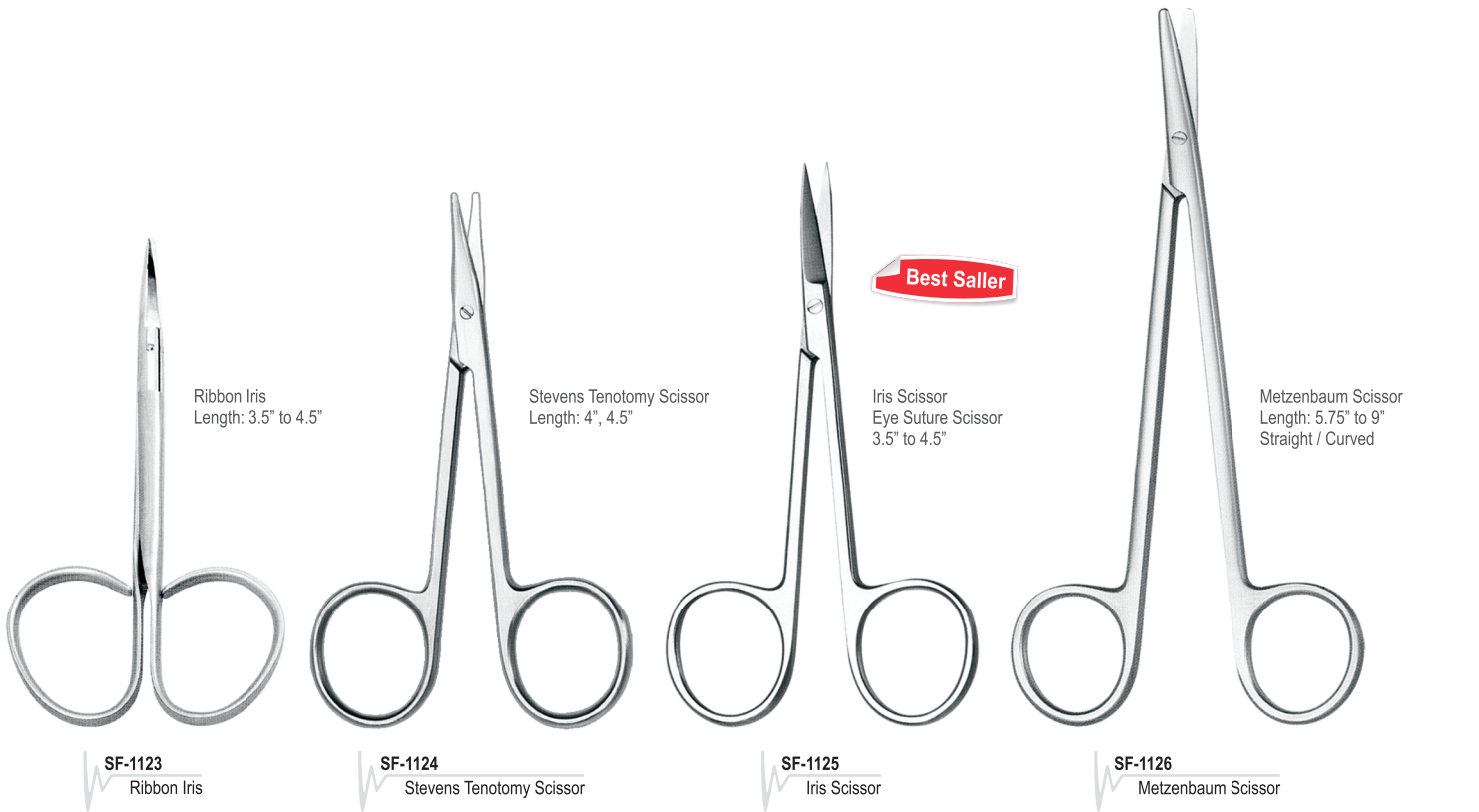

# Dissecting & Delicate Scissors

Scissors are available with & without Tungsten Carbide tips

[www.surgiforce.com](http://www.surgiforce.com)



Operating Scissor  
Length: 5" to 10"  
Straight / Curved

SF-1131  
Operating Scissor



TC Serrated Super Cut Iris  
Length: 5" to 10"  
Straight / Curved

SF-1132  
TC Serrated Super Cut Iris



Face Lift Scissor  
Length: 5" to 8"  
Straight / Curved

SF-1133  
Face Lift Scissor



Sharp / Sharp Operating Scissor  
Length: 5" to 10"  
Straight / Curved

SF-1134  
Sharp / Sharp Operating Scissor



Angled Iris 45° Scissor  
Length: 3.5" to 5"  
Straight / Curved

SF-1135  
Angled Iris 45° Scissor



Wire Scissor  
Length: 4.5"

SF-1136  
TC Wire Scissor



Mayo Scissor  
Straight / Curved  
Length: 5" to 10"

IM-S-1137  
TC Mayo Scissor



Kelly Scissor  
Length: 6", 7"  
Straight / Curved

SF-1138  
TC Kelly Scissor

Scissors are available with & without Tungsten Carbide tips



Olsen Hegar Needle Holder  
Length: 4.5" to 7.5"

SF-1139  
Olsen Hegar Needle holder



Derf Needle Holder  
Length: 4.5", 5"

SF-1140  
Derf Needle holder



Mathieu Needle Holder  
Length: 5" & 8"

SF-1141  
Mathieu Needle holder



Halsey Needle Holder  
Length: 4.75" to 5.5"

SF-1142  
Halsey Needle Holder



Crile Wood Needle Holder  
Length: 5.75" to 8"

SF-1143  
Crile Wood Needle Holder



Best Seller

Mayo Hegar Needle Holder  
Length: 6" to 12"

SF-1144  
Mayo Hegar Needle Holder



# Needle Holders

Scissors are available with & without Tungsten Carbide tips

[www.surgiforce.com](http://www.surgiforce.com)



Wire Twister  
Length: 8"

SF-1145  
Wire Twister



Martin Needle Holder  
Length: 6" to 10"

SF-1146  
Martin Needle Holder



Crile Wood Needle Holder  
Length: 6" to 10"

SF-1147  
Crile Wood Needle Holder



Mathieu Needle Holder  
Length: .5" & 8"

SF-1148  
Mathieu Needle Holder

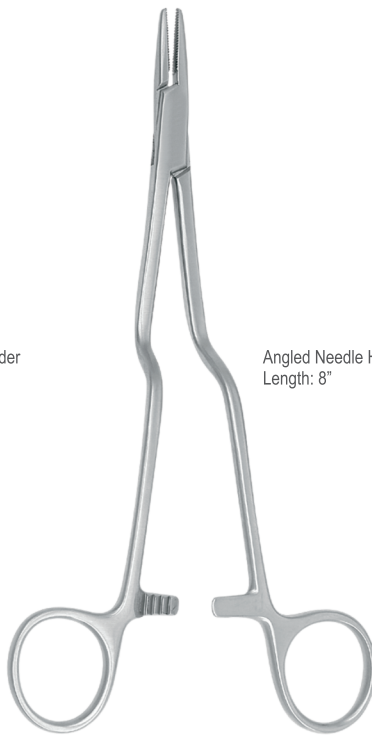

Angled Needle Holder  
Length: 8"

SF-1149  
Angled Needle Holder



Angled Needle Holder  
Length: 8"

SF-1150  
Angled Needle Holder



Adson Tissue Forcep  
Length: 4.75"

SF-1151  
Adson Tissue Forcep



Adson Dressing Forcep  
Length: 4.75"

SF-1152  
Adson Dressing Forcep



Delicate Dissecting  
Forcep  
Length: 3.5" to 5.75"

SF-1153  
Delicate Dissecting Forcep



Bonney Tissue Forcep  
Length: 7"

SF-1154  
Bonney Tissue Forcep



Gerald Forcep  
Length: 9"

SF-1155  
Gerald Forcep



Feilchenfeld Forcep  
Length: 7.5cm to 9.5cm

SF-1156  
Feilchenfeld Forcep



Bonaccolto Forcep  
Length: 4"

SF-1157  
Bonaccolto Forcep



Standard Dressing Forcep  
Length: 4" to 10"

SF-1158  
Standard Dressing Forcep



Delicate Dissecting  
Kocher Forcep  
Length: 4" to 8"

SF-1159  
Delicate Dissecting Kocher Forcep



Cushing Dissecting  
Forcep  
Length: 7" to 10"

SF-1160  
Cushing Dissecting Forcep

# Tissue, Dissecting & Dressing Forceps



Standard Dressing Forcep Slender Pattern Length: 4" to 10"

SF-1161 Standard Dressing Forcep Slender Pattern



Tissue Forcep Length: 4" to 12"

SF-1162 Tissue Forcep



Delicate Dissecting Forcep Length: 4"

SF-1163 Delicate Dissecting Forcep



Ferris Smith Forcep Length: 7"

SF-1164 Ferris Smith Forcep



Lung Dissecting Forcep Length: 9"

SF-1165 Lung Dissecting Forcep



Soft Tissue Forcep Length: 10.5cm

SF-1166 Soft Tissue Forcep

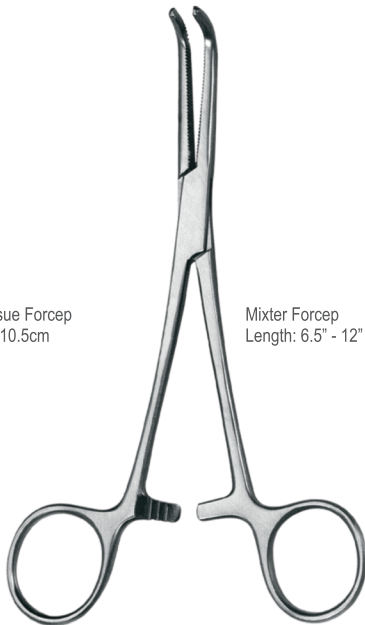

Mixer Forcep Length: 6.5" - 12"

SF-1167 Mixer Forcep



Hemostatic Crile Forcep Length: 5" to 6"

SF-1168 Hemostatic Crile Forcep



Lahey Clamp Length: 6" to 8"

SF-1169 Lahey Clamp



Hartman Mosquito Forcep  
Length: 3.5"  
Straight / Curved

SF-1170  
Hartman Mosquito Forcep



Best Seller

Halsted Mosquito Forcep  
Length: 5", 8"  
Straight / Curved

SF-1171  
Halsted Mosquito Forcep



Kelly Hemostatic Forcep  
Length: 5" to 6"  
Straight / Curved

SF-1172  
Kelly Hemostatic Forcep



Best Seller

Allis Forcep  
Teeth: 3x4, 4x5, 5x6, 6x7  
Length: 5" to 10"

SF-1173  
Allis Forcep

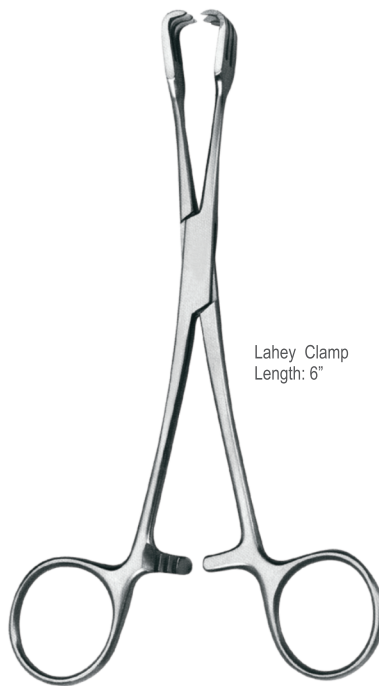

Lahey Clamp  
Length: 6"

SF-1174  
Lahey Clamp



Rochester Pean Forcep  
Length: 6.5", 7.5"

SF-1175  
Rochester Pean Forcep

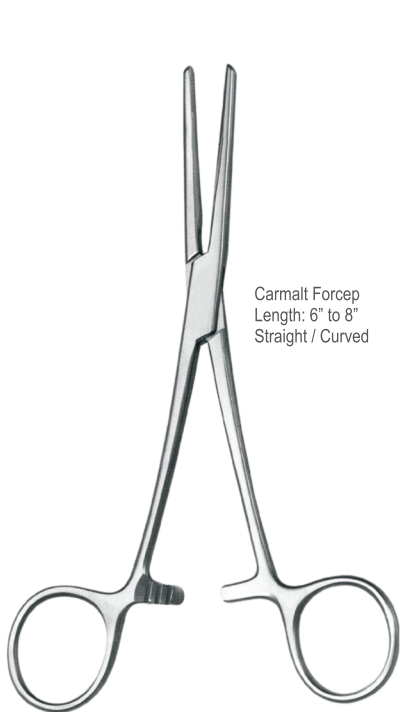

Carmalt Forcep  
Length: 6" to 8"  
Straight / Curved

SF-1176  
Carmalt Forcep



Kocher Forcep  
Length: 5" to 12"

SF-1177  
Kocher Forcep

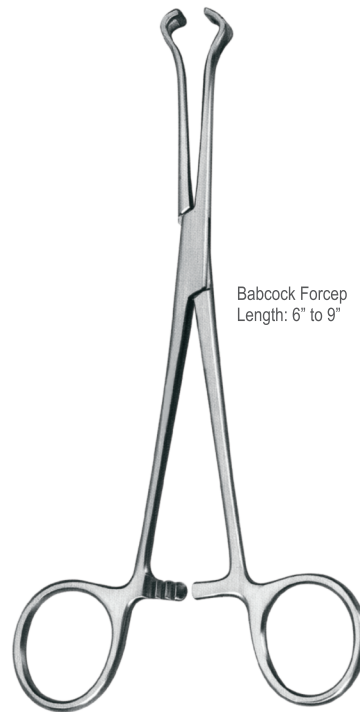

Babcock Forcep  
Length: 6" to 9"

SF-1178  
Babcock Forcep



Foerster Sponge Forcep  
Length: 7.5" to 9.5"

SF-1179  
Foerster Sponge Forcep

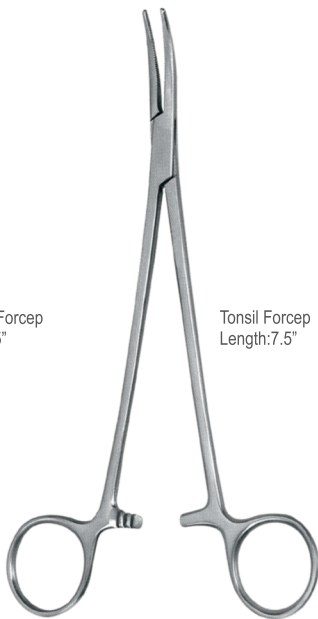

Tonsil Forcep  
Length: 7.5"

SF-1180  
Tonsil Forcep



Backhaus Towel Clamp  
Length" 3.5" to 5.5"

SF-1181  
Backhaus Towel Clamp



Jones Towel Forcep  
Length: 2.5" to 3.5"

SF-1182  
Jones Towel Forcep

Scalpel Blades (Removable)



SF-1183

No. 3, Solid  
Size: 4.75"



SF-1184

No. 3, Solid With Scale  
Size: 5"



SF-1185

No. 3, Solid  
Size: 5"



SF-1186

No. 4  
Size: 5"  
Blade that fit: 20,21,22,23



SF-1187

No. 7  
Size: 6.5"



SF-1188

Hollow Round



SF-1189

No. 3  
Angled Solid, Round



Debakey Tissue Forcep  
Length: 6"- 11"  
Jaw Width: 1.0mm, 1.5mm,  
2.0mm, 2.5mm, 3.0mm

SF-1190  
Debakey Tissue Forcep



Glover Bulldog Clamp  
Length: 7 cm, 8 cm, 9 cm, 11 cm  
Tip/Jaw: Straight and curved jaws (tips)

SF-1191  
Glover Bulldog Clamp



Debakey Bulldog Clamp  
Length: 7.5 cm, 8.5 cm, 10.5 cm,  
12 cm  
Tip/Jaw: Straight and curved jaws  
(tips)

SF-1192  
Debakey Bulldog Clamp



Debakey Ring Handled Clamp  
Length: 4", 4.5", 4.75", 5"  
Tip/jaws: Straight, curved, angled

SF-1193  
Debakey Ring Handled Clamp

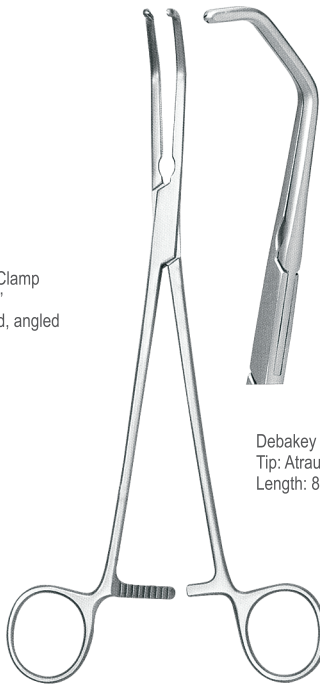

Debakey Tangential Occlusion Clamp  
Tip: Atraumatic jaws  
Length: 8", 10", 10.25", 10.5, 11"

SF-1194  
Debakey Tangential Occlusion Clamp

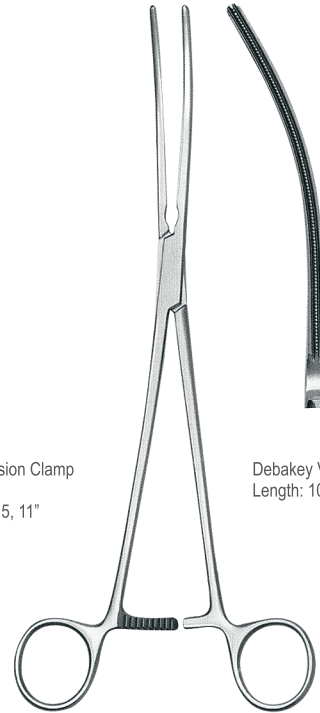

Debakey Vascular Clamp, Large  
Length: 10", 10.5", 12.25", 12.75"

SF-1195  
Debakey Vascular Clamp, Large



Allison Lung Retractor  
Length: 12.5", 2" wide blade

SF-1196  
Allison Lung Retractor

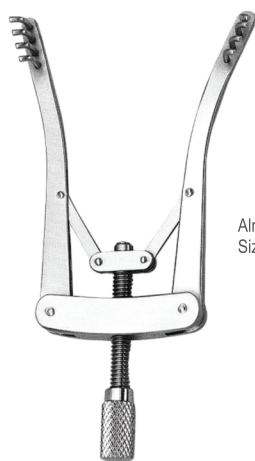

Alm Retractor  
Sizes: 2.5" & 3.5"

SF-1197  
Alm Retractor

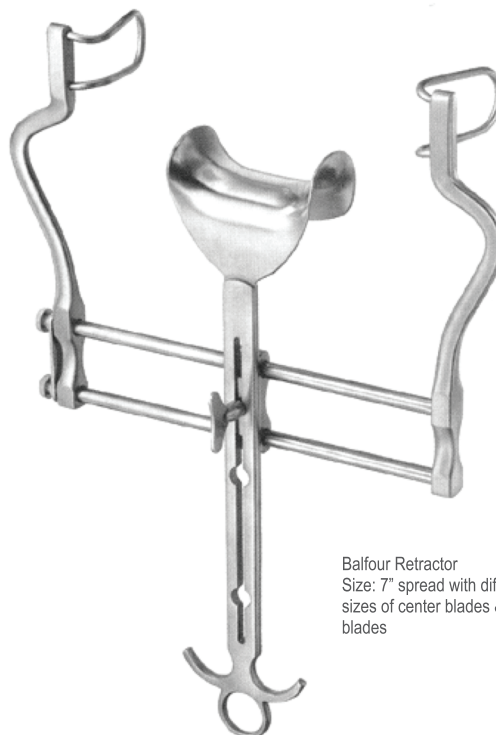

Balfour Retractor  
Size: 7" spread with different sizes of center blades & side blades

SF-1198  
Balfour Retractor



Meyering Finger Retractor  
Length: 7"  
Blade Size: 4 mm, 5 mm, 7 mm

SF-1199  
Meyering Finger Retractor



Volkman Retractor  
Size: 7.5" long with 2, 3, 4, 5, or 6 prongs - sharp or dull

SF-1200  
Volkman Retractor



Langenbeck  
Length: 22 cm  
28x10 mm, 28x14 mm  
28x16 mm, 33x14 mm  
40x11 mm, 40x13 mm

SF-1201  
Langenbeck



Roux  
Length: 14 cm, 15 cm, 17 cm

SF-1202  
Roux



# Retractors

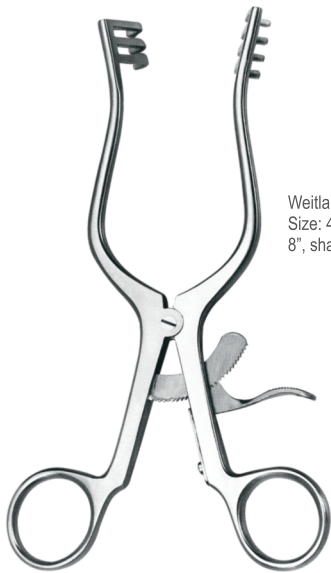

Weitlaner Retractor  
Size: 4.5", 5.5", 6.5", 7.5",  
8", sharp and blunt prongs

SF-1203  
Weitlaner Retractor



Gelpi Retractor  
Size: 3.5", 4.5", 5.5",  
and 7" with sharp  
singular prongs

SF-1204  
Gelpi Retractor



Deaver Retractor  
Size: .375", .75", .5", 1",  
1.5", 2", 3"  
Length: 7", 8", 9", 12", 13"

SF-1205  
Deaver Retractor

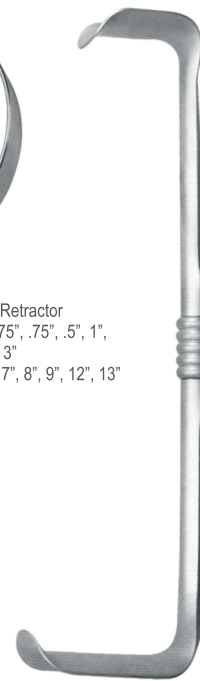

Richardson-eastman  
Retractor  
Length: 10", 11"  
49 X 28 / 63 X 49 mm  
28 X 20 / 35 X 28 mm

SF-1206  
Richardson-Eastman Retractor



Richardson Retractor &  
Kelly Retractor  
Length: 9.5" 10"  
Blades size is 2" Larger in  
Kelly Retractor

SF-1207  
Richardson Retractor



Richardson Retractor  
with Hollow Handle  
Length: 9.5" & 10"

SF-1208  
Richardson Retractor  
with Hollow Handle

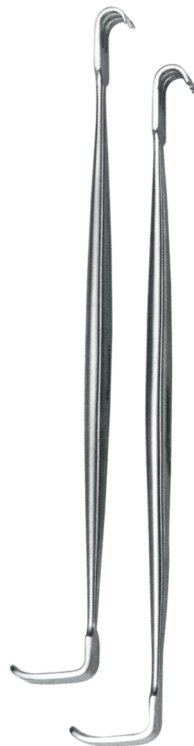

Senn-Miller Retractor  
Length: 6.5, sharp and blunt  
prongs 7 mm, 8 mm

SF-1209  
Senn-Miller Retractor



Crile Retractor  
Length: 4.5"

SF-1210  
Crile Retractor

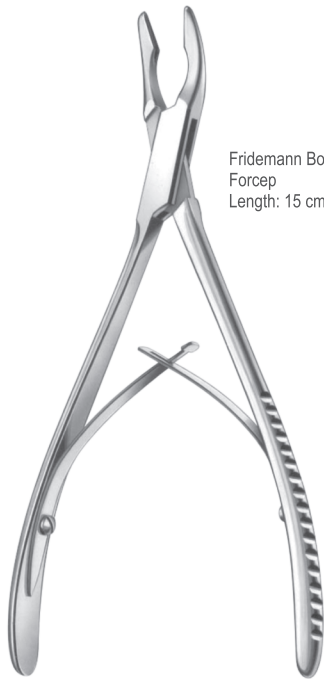

Fridemann Bone Rongeur  
Forcep  
Length: 15 cm

SF-1211  
Fridemann Bone Rongeur Forcep



Ruskin Bone Cutting Forcep  
Length: 5.5" & 7.5"

SF-1212  
Ruskin Bone Cutting Forcep



Ruskin Rongeur, Double Action  
Size: 6", 7.25"  
Tip: 3 mm, 5 mm, 7 mm

SF-1213  
Ruskin Rongeur, Double Action



Kern Bone Holding  
Forcep  
Length: 6cm, 24 cm

SF-1214  
Kern Bone Holding



Mead Mallet  
Length: 7.5", 8 oz. Head

SF-1215  
Mead Mallet



Gerzog Mallet  
Length: 7.5", 8oz. Head

SF-1216  
Gerzog Mallet



Doyen Elevator Rasp  
Length: 7", adult and child

SF-1217  
Doyen Elevator Rasp



Bailey Rib Contractor  
Tip: 3 prongs on two arms



Lowman Bone Holding Clamp  
Length: 5", 7", 8", calibrated on .125"  
Tip Measurement: 1 x 2 prong jaws 5" clamp has .75" wide jaws 7" clamp has 1" wide jaws 8" clamp has 1.25" wide jaws



Hibbs Gouge  
Length: 9", Straight / Curved  
Gouge Width: 1/4", 3/8", 1/2", 5/8", 3/4", 7/8", 1"



Hoke Osteotome  
Length: 5.5"  
Tip Measurement: Osteotome width: 1/8", 3/16", 1/4", 5/16", 3/8", 1/2"



Langenbeck Periosteal Elevator  
Other Names: Joker, Cushing Joker  
Length: 7.5"



Periosteal Elevator  
Length: 7", 8", 9"

SF-1218  
Bailey Rib Contractor

SF-1219  
Lowman Bone Holding Clamp

SF-1220  
Hibbs Gouge

SF-1221  
Hoke Osteotome

SF-1222  
Langenbeck

SF-1223  
Periosteal Elevator



Hohmann Retractor  
Length: 9.25" and 9.75"  
(6.5" define as Mini Hohman)



SF-1225  
Finocchio Rib Spreader

Finocchio Rib Spreader  
Length: 6", 8", 10", and 12"  
spread with straight arms 8", 10", and 12" spread with curved arms



Laminectomy Rongeurs  
Length: 7" to 8"  
Up-Bite: 1mm, 2mm, 3mm, 4mm, 5mm  
Down-Bite: 1mm, 2mm, 3mm, 4mm, 5mm  
Angle: 45° & 90° up & down

SF-1224  
Hohmann Retractor

SF-1226  
Laminectomy Rongeurs



SF-1227  
Poole Suction Tube

Poole Suction Tube  
Length: 9"



SF-1228  
Baron Suction Tube

Baron Suction Tube  
Length: 7.5cm



SF-1229  
Frazier Suction Tube

Frazier Suction Tube  
7FG, 8FG, 9FG, 10FG, 12FG,  
Length: 7"

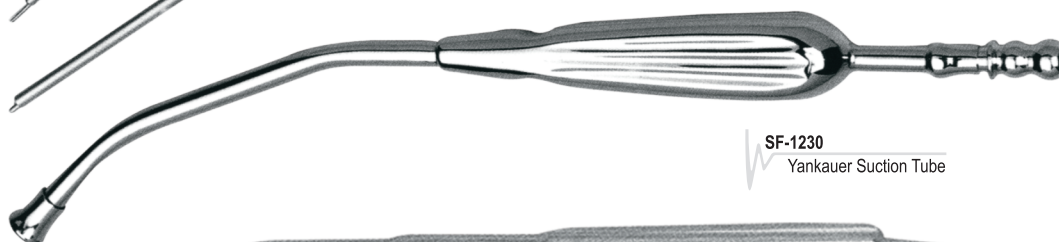

SF-1230  
Yankauer Suction Tube

Yankauer Suction Tube Complete  
Length: 12"



SF-1231  
Intercardiac Suction Devices

Intercardiac Suction Device  
Length: 10.5", Junior size 7"



SF-1232  
Spackman Cannula

Spackman Cannula  
Disposable and Latexfree Cone  
Surgical use: Dilator for assessing  
the depth of the uterus and to allow  
for gentle dilation of the cervix.



Fomon Retractor  
Length: 6.5"  
Tip: Two prongs 11mm wide  
with 2 ball prongs

SF-1233  
Fomon Retractor



Joseph Hook  
Length: 6.25"  
Tip: Single hook, double hook  
2mm, 5mm, 7mm, 10mm

SF-1234  
Joseph Hook



Fomon Periosteal Elevator  
Length: 6.25"

SF-1235  
Fomon Periosteal Elevator



Ballenger Swivel Knife  
Length: 7.75"  
Tip: Movable cutting edge  
3mm, 4mm, 5mm

SF-1236  
Ballenger Swivel Knife



Barnhill Adenoid Curette  
Length: 8.5"  
Tip: Cutting blades 11mm,  
13mm, 15mm, 17mm, 19mm

SF-1237  
Barnhill Adenoid Curette



Aufricht Retractor  
Length: 6.5"

SF-1238  
Aufricht Retractor



Jansen Ear Forcep  
Length: 5.5", 6.5"  
Tip: Serrated tips and 1x2  
teeth

SF-1239  
Jansen Ear Forcep



Killian Septum Speculum  
Length: 6"  
Tip/Jaw: Blades of 2", 2.5, 3", 3.5"

SF-1240  
Killian Septum Speculum

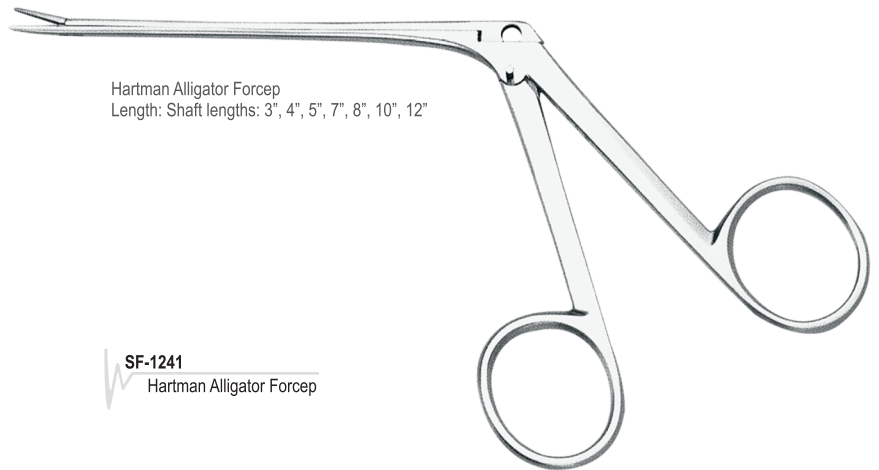

Hartman Alligator Forcep  
Length: Shaft lengths: 3", 4", 5", 7", 8", 10", 12"

SF-1241  
Hartman Alligator Forcep

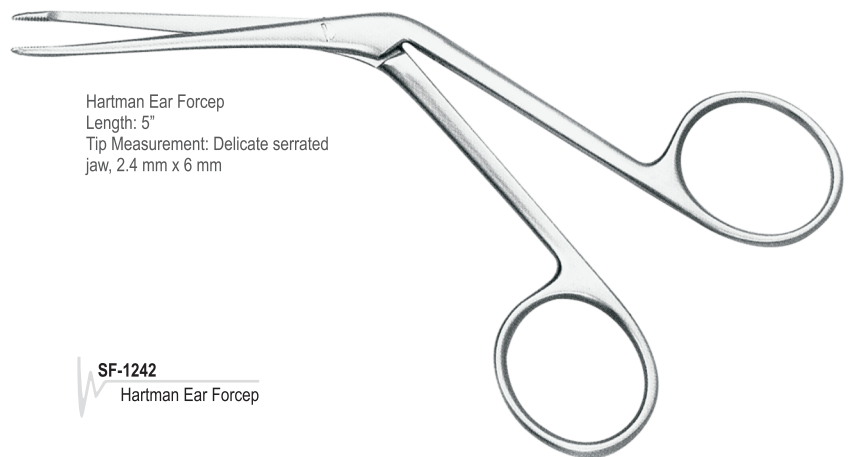

Hartman Ear Forcep  
Length: 5"  
Tip Measurement: Delicate serrated  
jaw, 2.4 mm x 6 mm

SF-1242  
Hartman Ear Forcep



Hartman Ear Specula  
Diameter: 3 mm, 4 mm, 5 mm

SF-1243  
Hartman Ear Specula

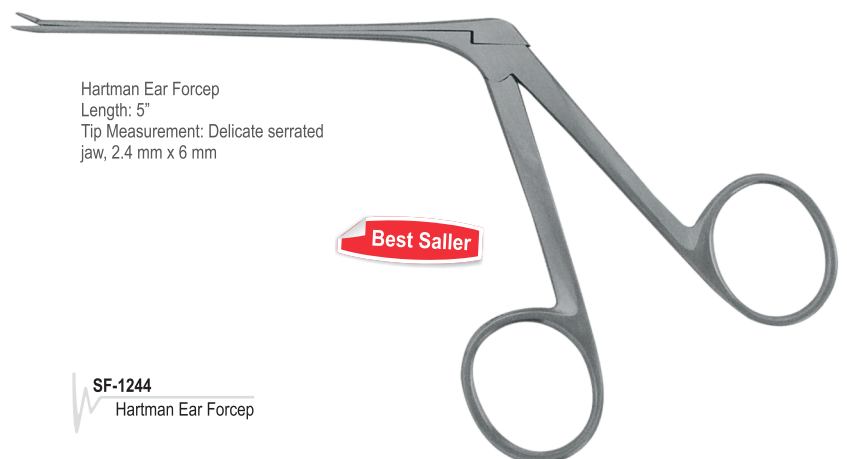

Hartman Ear Forcep  
Length: 5"  
Tip Measurement: Delicate serrated  
jaw, 2.4 mm x 6 mm

SF-1244  
Hartman Ear Forcep



Simpson Obstetrical Forcep  
Length: 12", 14"  
Tip: Open fenestrated

SF-1245  
Simpson Obstetrical

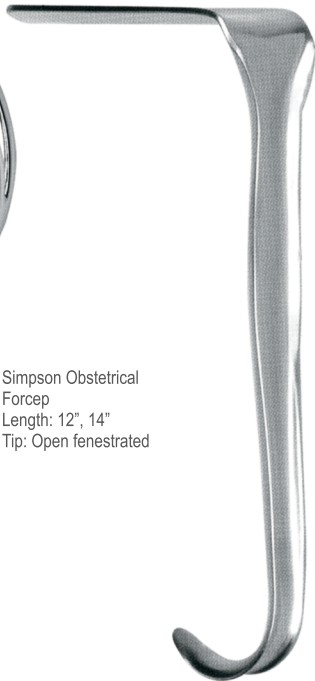

Jackson Vaginal Retractor  
Length: 7"  
Blade Measurement:  
1.5" W x 3" L  
1.5" W x 3.5" L  
1.5" W x 4" L

SF-1246  
Jackson Vaginal Retractor



Kavorkian - Younge Biopsy Curette  
Type: Curette with and without basket  
Length: 12"

SF-1247  
Kavorkian - Younge Biopsy Curette



Novak Uterine Curette  
Length: 9.75", 4mm or 2 mm diameter  
Tip: Slightly curved cannulated tip

SF-1248  
Novak Uterine Curette



Iowa Trumpet Pudendal Needle Guide  
Length: 5.5"

SF-1249  
Iowa Trumpet Pudendal Needle Guide

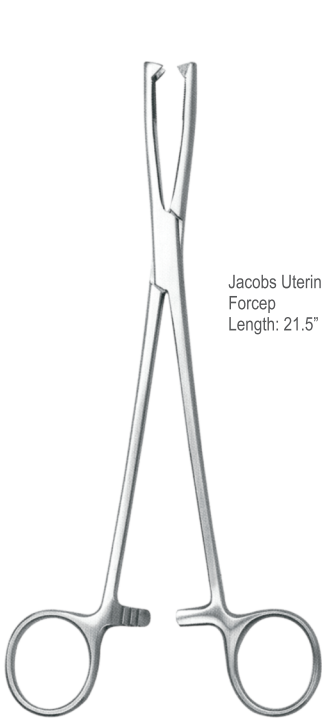

Jacobs Uterine Vulsellum Forcep  
Length: 21.5" cm

SF-1250  
Jacobs Uterine Vulsellum Forcep

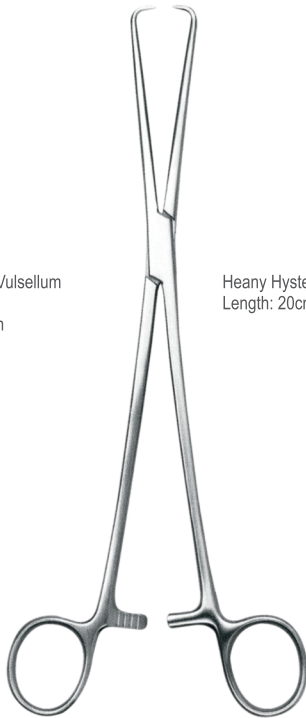

Heany Hysterectomy Forcep  
Length: 20cm to 24.5 cm

SF-1251  
Heany Hysterectomy Forcep

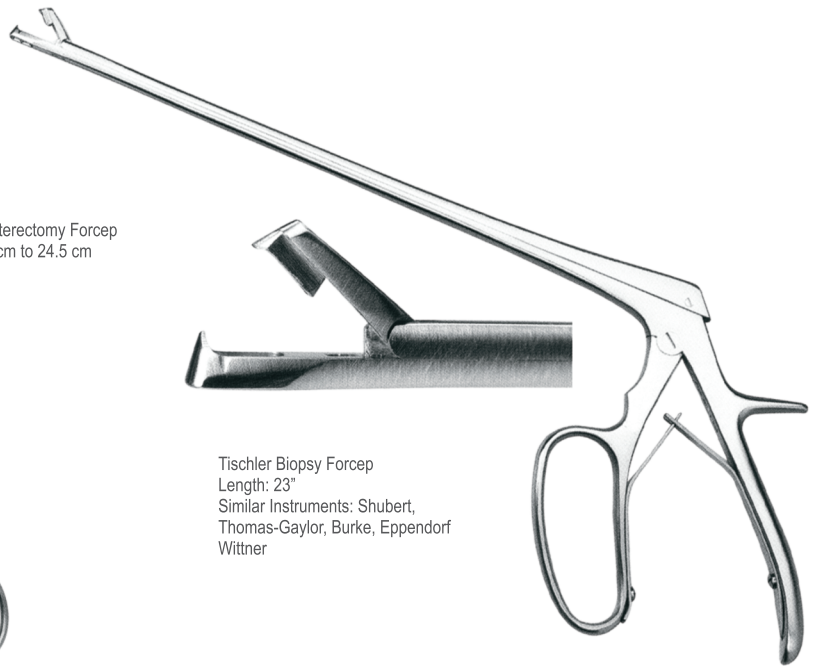

Tischler Biopsy Forcep  
Length: 23"  
Similar Instruments: Shubert, Thomas-Gaylor, Burke, Eppendorf Wittner

SF-1252  
Tischler Biopsy Forcep



Castroviejo Corneal Scissor  
Length: 4"

SF-1253

Castroviejo Corneal Scissor



Castroviejo Needle holder with Tungsten Carbide Tip  
Jaw Description: Smooth or Serrated  
Length: 5.5", 7", 8.5"

SF-1254

Castroviejo Needle Holder

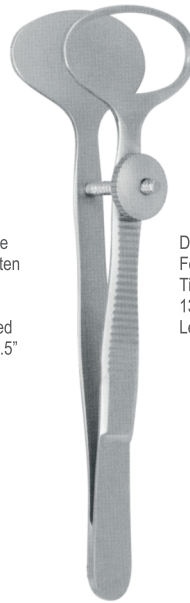

Desmarres Chalazian Forcep  
Tip/Blades: 11 mm, 13 mm, 15 mm, 18 mm  
Length: 9 cm

SF-1255

Desmarres Chalazian Forcep

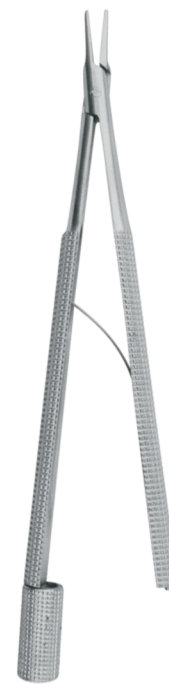

Blade Breaker Holder  
Length: 4.75", 5.5"

SF-1256

Blade Breaker Holder

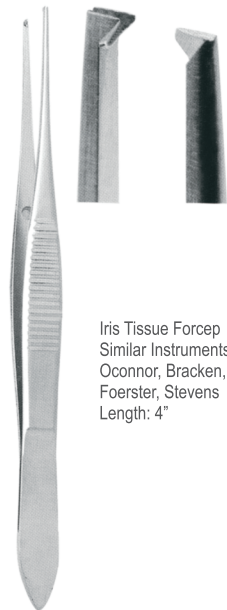

Iris Tissue Forcep  
Similar Instruments: Oconnor, Bracken, Foerster, Stevens  
Length: 4"

SF-1257

Iris Tissue Forcep



Graefe Fixation Forcep  
Similar Instruments: Waldean, Guyton Noyes  
Length: 4 3/8"

SF-1258

Graefe Fixation Forcep



Castroviejo Suturing Forcep with Teeth  
Similar Instruments: Troutman, Barraquer, Pierser  
Length: 4"

SF-1259

Castroviejo Suturing Forcep



Castroviejo Eye Speculum  
Similar Instruments: Lancaster, Knapp, Lange, Williams  
Length: 3.75", 4"

SF-1260

Castroviejo Eye Speculum





Iris Spring Scissor  
Length: 10 cm, 12 cm

SF-1261  
Iris Spring Scissor



Westcott Scissor  
Length: 11 cm, 12 cm

SF-1262  
Westcott Scissor



Mcperson Forcep  
Length: 11 cm

SF-1263  
Mcperson Forcep



Bishop-Harmann  
Length: 8.5 cm

SF-1264  
Bishop-Harmann



Bonn Forcep  
Length: 10 cm

SF-1265  
Bonn Forcep



S.T. Martin Forcep  
Length: 10 cm

SF-1266  
S.T. Martin Forcep



Lambert Chalazian Forcep  
Length: 9 cm

SF-1267  
Lambert Chalazian Forcep



Colibri Forcep  
Length: 7 cm

SF-1268  
Colibri Forcep



Jwellery Forcep No. 5  
Length: 11 cm

SF-1269  
Jwellery Forcep



Azar Lens Manipulator Hook  
Similar Instruments: Kuglen, Fenzi, Lester  
Length: 12 cm

SF-1270  
Azar Lens Manipulator Hook



Micro Scissor  
Length: 10 cm

SF-1271  
Micro Scissor



Micro Needle Holder  
Length: 14 cm, 18 cm

SF-1272  
Micro Needle Holder



Spring Needle Holder  
with Tungsten Carbide  
Tip  
Length: 15 cm, 18 cm

SF-1273  
Spring Needle Holder



Gomel Micro Scissor  
Length: 14 cm, 18 cm

SF-1274  
Gomel Micro Scissor



Castroviejo, Genon  
with Tungsten Carbide  
Tip  
Length: 15 cm, 18 cm

SF-1275  
Castroviejo, Genon



Micro Forcep  
Length: 17.5 cm

SF-1276  
Micro Forcep



Yasargil Micro Forcep  
Length: 18 cm, 20 cm,  
22 cm

SF-1277  
Yasargil Micro Forcep



Muller Forcep  
Length: 10 cm

SF-1278  
Muller Forcep

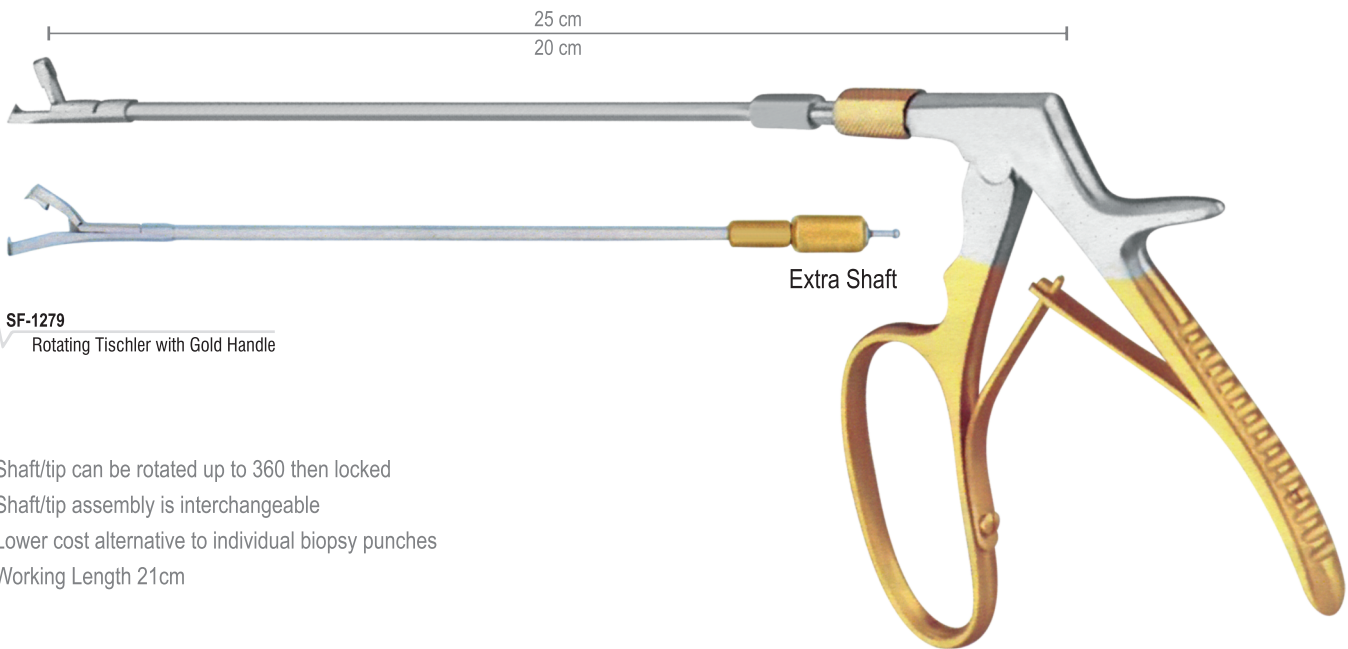

**SF-1279**  
Rotating Tischler with Gold Handle

- Shaft/tip can be rotated up to 360 then locked
- Shaft/tip assembly is interchangeable
- Lower cost alternative to individual biopsy punches
- Working Length 21cm

**Bite size: 7mm x 3mm**

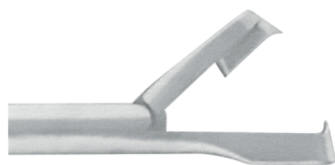

Tischler, Straight



Tischler, Down



Tischler, Up

**Bite size: 4.2mm x 2.3mm**

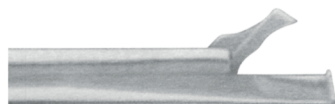

Mini-Tischler, Straight

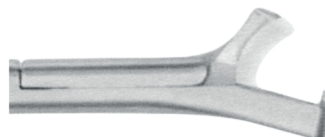

Mini-Tischler, Down

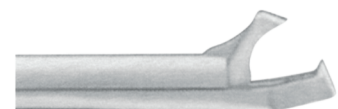

Mini-Tischler, Up

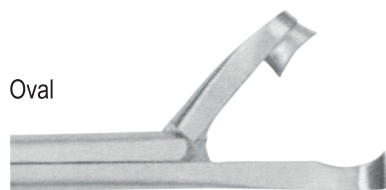

Oval

**Bite size: 5mm x 3mm**



Kevorkian

**Bite size: 8mm x 3mm**



Sizes:  
3mm tip  
4mm tip  
5mm tip  
7mm tip

**SF-1280**  
Kogan Endocervical Speculum  
Ratchet Handle or No Lock Handle

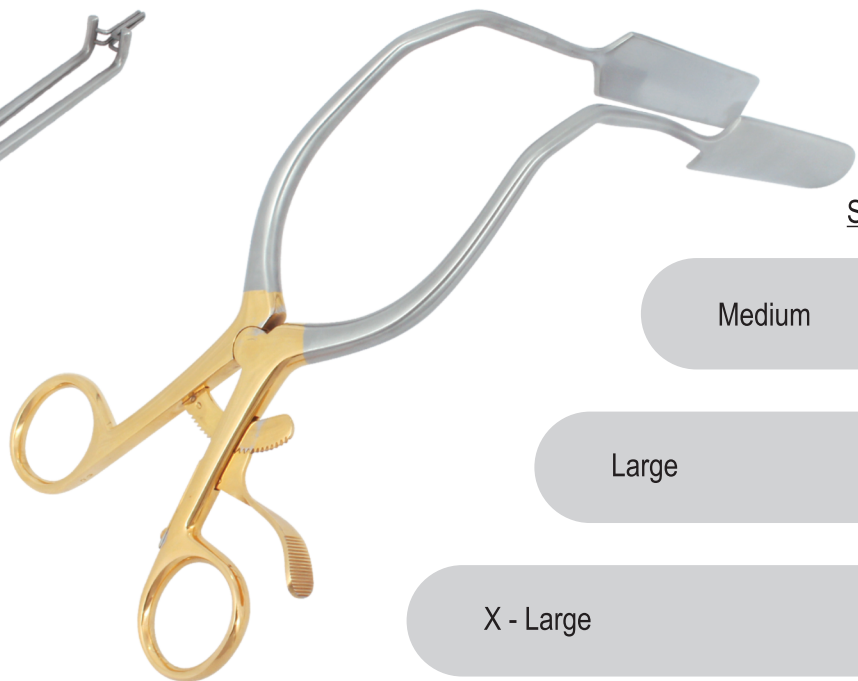

Sizes

Medium

Large

X - Large

**SF-1281**  
Lateral Vaginal Retractor



Sizes:  
Length: 25 cm  
Length: 30 cm



Foerster Sponge Forceps  
Straight / Angled Handle

**SF-1282**  
Foerster Sponge Forceps

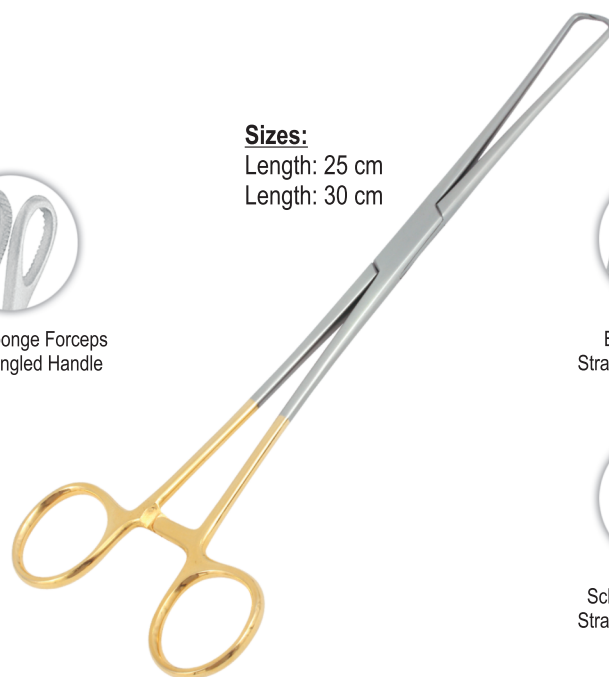

Sizes:  
Length: 25 cm  
Length: 30 cm



Braun Tenaculum  
Straight / Angled Handle



Schroeder Tenaculum  
Straight / Angled Handle

**SF-1283**  
Schroeder-Braun Tenaculum



31cm

SF-1284  
Endocervical Curettes

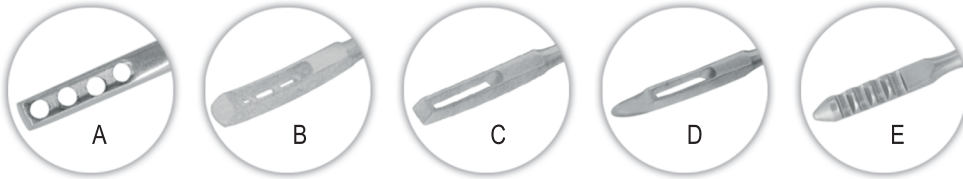

31cm

SF-1285  
Endocervical Curettes

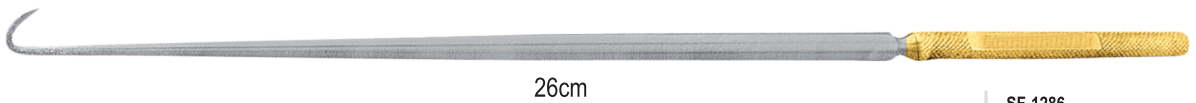
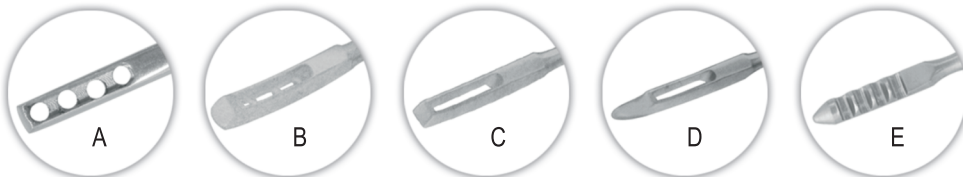

26cm

SF-1286  
Hooks

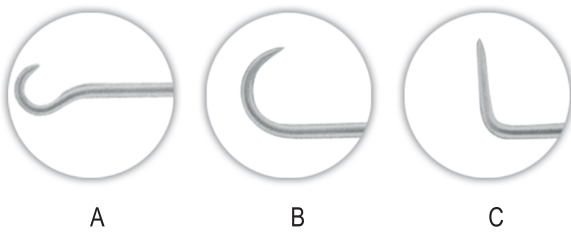

SF-1287  
Vulvar key Punches

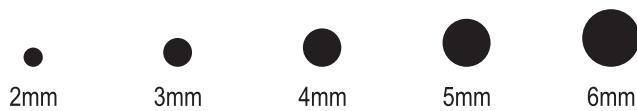

2mm

3mm

4mm

5mm

6mm

Size



2mm, 3mm, 4mm

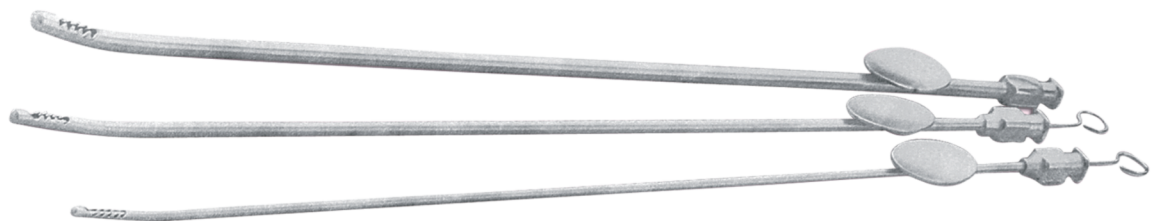

SF-1288  
Novak Curettes

## Conventional Laryngoscopes



### Macintosh Conventional

Blade Ref.	Size	Working Length (mm)
SF - 1300 - 55	0	55
SF - 1300 - 70	1	70
SF - 1300 - 78	2	78
SF - 1300 - 90	2	90
SF - 1300 - 10	3	108
SF - 1300 - 13	4	133
SF - 1300 - 15	5	150

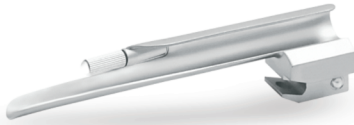

### Miller Conventional

Blade Ref.	Size	Working Length (mm)
SF - 1305 - 45	00	45
SF - 1305 - 55	0	55
SF - 1305 - 80	1	80
SF - 1305 - 13	2	130
SF - 1305 - 17	3	170
SF - 1305 - 18	4	180

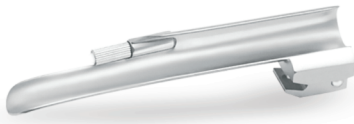

### Wisconsin Conventional

Blade Ref.	Size	Working Length (mm)
SF - 1310 - 71	1	71
SF - 1310 - 90	2	90
SF - 1310 - 11	3	110
SF - 1310 - 13	4	137



### Macintosh Flexible Tip Conventional

Blade Ref.	Size	Working Length (mm)
SF - 1315 - 90	2	90
SF - 1315 - 10	3	108
SF - 1315 - 13	4	133
SF - 1315 - 15	5	150

## Fiberoptic Laryngoscopes Interchangeable



### Macintosh Fiber Optic (Cold Light Guide Interchangeable)

Blade Ref.	Size	Working Length (mm)
SF - 1400 - 55	0	55
SF - 1400 - 70	1	70
SF - 1400 - 78	2	78
SF - 1400 - 90	2	90
SF - 1400 - 10	3	108
SF - 1400 - 13	4	133
SF - 1400 - 15	5	150



### Miller Fiber Optic (Cold Light Guide Interchangeable)

Blade Ref.	Size	Working Length (mm)
SF - 1405 - 45	00	45
SF - 1405 - 55	0	55
SF - 1405 - 80	1	80
SF - 1405 - 13	2	130
SF - 1405 - 17	3	170
SF - 1405 - 18	4	180



### Wisconsin Fiber Optic (Cold Light Guide Interchangeable)

Blade Ref.	Size	Working Length (mm)
SF - 1410 - 71	1	71
SF - 1410 - 90	2	90
SF - 1410 - 11	3	110
SF - 1410 - 13	4	137



### Macintosh Flexible Tip - Fiber Optic (Cold Light Guide Interchangeable)

Blade Ref.	Size	Working Length (mm)
SF - 1415 - 90	2	90
SF - 1415 - 10	3	108
SF - 1415 - 13	4	133
SF - 1415 - 15	5	150

## Fiberoptic Laryngoscopes Fixed



### Macintosh Fiber Optic (Cold Light Guide Fixed)

Blade Ref.	Size	Working Length (mm)
SF - 1350 - 55	0	55
SF - 1350 - 70	1	70
SF - 1350 - 78	2	78
SF - 1350 - 90	2	90
SF - 1350 - 10	3	108
SF - 1350 - 13	4	133
SF - 1350 - 15	5	150



### Miller Fiber Optic (Cold Light Guide Fixed)

Blade Ref.	Size	Working Length (mm)
SF - 1355 - 45	00	45
SF - 1355 - 55	0	55
SF - 1355 - 80	1	80
SF - 1355 - 13	2	130
SF - 1355 - 17	3	170
SF - 1355 - 18	4	180



### Wisconsin Fiber Optic (Cold Light Guide Fixed)

Blade Ref.	Size	Working Length (mm)
SF - 1360 - 71	1	71
SF - 1360 - 90	2	90
SF - 1360 - 11	3	110
SF - 1360 - 13	4	137



### Macintosh Flexible Tip (Cold Light Guide Fixed)

Blade Ref.	Size	Working Length (mm)
SF - 1365 - 90	2	90
SF - 1365 - 10	3	108
SF - 1365 - 13	4	133
SF - 1365 - 15	5	150



### Mega Fiber Optic (Cold Light Guide Fixed)

Blade Ref.	Size	Working Length (mm)
SF - 1370 - 80	0	80
SF - 1370 - 90	1	93
SF - 1370 - 11	2	114
SF - 1370 - 13	3	135
SF - 1370 - 15	4	155
SF - 1370 - 17	5	175

## Single Use Laryngoscopes Conventional



### Macintosh Conventional (Metal heal)

Blade Ref.	Size	Working Length (mm)
SF - 1500 - 55	0	55
SF - 1500 - 70	1	70
SF - 1500 - 78	2	78
SF - 1500 - 90	2	90
SF - 1500 - 10	3	108
SF - 1500 - 13	4	133
SF - 1500 - 15	5	150



### Miller Conventional (Metal heal)

Blade Ref.	Size	Working Length (mm)
SF - 1505 - 45	00	45
SF - 1505 - 55	0	55
SF - 1505 - 80	1	80
SF - 1505 - 13	2	130
SF - 1505 - 17	3	170
SF - 1505 - 18	4	180



### Macintosh Conventional (Plastic molded heal)

Blade Ref.	Size	Working Length (mm)
SF - 1510 - 55	0	55
SF - 1510 - 70	1	70
SF - 1510 - 78	2	78
SF - 1510 - 90	2	90
SF - 1510 - 10	3	108
SF - 1510 - 13	4	133
SF - 1510 - 15	5	150



### Miller Conventional (Plastic molded heal)

Blade Ref.	Size	Working Length (mm)
SF - 1515 - 45	00	45
SF - 1515 - 55	0	55
SF - 1515 - 80	1	80
SF - 1515 - 13	2	130
SF - 1515 - 17	3	170
SF - 1515 - 18	4	180



## Conventional Handles:

- ISO 7376 Fiber Optic Fitting.
- Powerful xenon illumination.
- Knurled Finish for secure & positive grip.
- Batteries not included.

Ref #	Size	Batteries
SF - 1600 - 01	Large	2 x "D"
SF - 1600 - 02	Medium/Standard	2 x "C"
SF - 1600 - 03	Small/PenLight	2 x "AA"
SF - 1600 - 04	Stubby	2 x "AA"
SF - 1600 - 05	Micro	Lithium 123



SF-1651  
Mini Otoscope

**Conventional**  
(pocket Style)

Mini Standard Otoscope Compact Design with extra bright light 2.5 v. Designed to be suitable for both students and doctors.

Requires: 2x AA Batteries ( not included with set ) .

Packing: In Gray or Black pouch with 10 disposable Specula

Dia 2.5mm & 4.0 mm

Available Colours: ■ ■ ■ ■



SF-1652  
Metal Otoscope

**Fiber Optic**  
Metal Otoscope

Equipped with an easy to use Bayonet connecting system with high quality professional metal head and chrome plated knurled battery handle making the surface a secure grip in the hand with extra bright light of 2.5v LED bulb illumination provided through Fiber Optic system. Three times High Quality magnifying Lens.

Requires: 2xC batteries ( Not included with set )

Packing: In Black soft zipper pouch with 10 Specula having Dia 2.5mm & 4.0mm



SF-1653  
Metal Otoscope

**Conventional**  
Metal Otoscope

Standard metal Otoscope with bayonet connecting head fitting. Ideal for pneumatic tympanic membrane test and every day ENT use. 2.5 v LED white Light. Available in Satin & polish Finish.

Requires: 2xC batteries ( Not included with set )

Packing: In Black soft zipper pouch with 10 Specula having Dia 2.5mm & 4.0mm



SF-1654  
Veterinary Otoscope

**Conventional**

Veterinary Metal Otoscope

Open system with rotatable lens and optional speculum for convenient procedures. 2.5v Otoscope.

Requires: 2xC batteries ( Not included with set )

Packing: In Black soft zipper pouch with 3 VET reusable Specula

Dia 4.0, 5.0, 7.0 mm



SF-1655  
Ophthalmoscope

**Ophthalmoscope**

Veterinary Metal Otoscope

Lock system Ophthalmoscope set . Lens selection wheel permits choice of corrective lenses from 0 to -25 and 0 to +25 single large circle aperture. Rheostat for adjustment of illumination .

Requires: 2xC batteries ( Not included in set )

Supply: Soft Pouch or Plastic hard case



SF-1656  
Dermatoscope

**Dermatoscope**

Bayonet locking system for easy engagement and disengagement from the handle. 2.5v Xenon/Halogen illumination of the examination field. High resolution achromatic lenses system with 10x magnification. Adjustable focusing Eyepiece for a large correction range. Lens with scale from 0-10mm for exact measurement of pigmented skin lesions. Soft eyepiece protection. Available in Polish and Sand finish.

Requires: 2xC batteries.

Supply: Soft black zipper pouch or hard case packing with extra glass plate (Scale 0- 10).



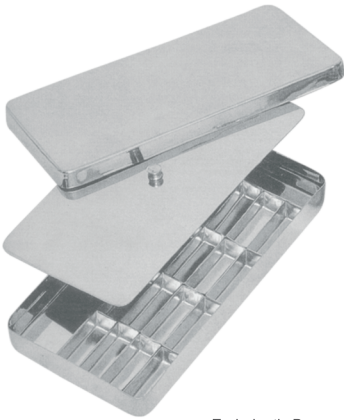

**SF-1700**  
Endodontic Box  
Endodontic Box  
17X17X3 cm / 20X10X4 cm  
25X12X6 cm / 30X14X6 cm

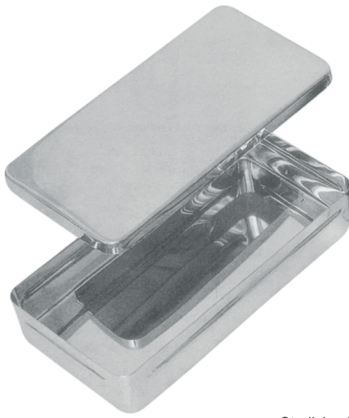

**SF-1701**  
Sterilizing Box  
Sterilizing Box  
17X17X3 cm / 20X10X4 cm  
25X12X6 cm / 30X14X6 cm



**SF-1702**  
Endo Tray Box  
Endo Tray Box



**SF-1703**  
Instrument Box With Lock  
Instrument Box With Lock  
8" X 4" X 1/2" / 8" X 6" X 2"  
10" X 6" X 2" / 12" X 6" X 2"  
12" X 8" X 2"



**SF-1704**  
Instrument Box  
Instrument Box  
8" X 4" X 1 / 8" X 6" X 2"  
10" X 6" X 2" / 12" X 6" X 2"  
12" X 8" X 2"



**SF-1705**  
Perforated Sterilizing Box  
Perforated Sterilizing Box  
8" X 4" X 1 / 8" X 6" X 2"  
10" X 6" X 2" / 12" X 6" X 2"  
12" X 8" X 2"



**SF-1706**  
Sterilizing Drum  
Sterilizing Drum  
6"x5"



**SF-1707**  
Sterilizing Drum  
Sterilizing Drum  
6"x6"



**SF-1708**  
Sterilizing Drum  
Sterilizing Drum  
8"x8"



**SF-1709**  
Irrigator (Douch Can)  
Irrigator (Douch Can)  
1000 ml / 1500 ml / 2000 ml



**SF-1710**  
Graduated Jug  
Graduated Jug  
500 ml / 1000 ml / 2000 ml



**SF-1711**  
Kidney Tray  
Kidney Tray  
Emesis Basins (Deep)  
5" 6" 8" 10" 11" 12" 14"



**SF-1712**  
Ounce

Ounces  
10, 20, 40, 60, 80



**SF-1713**  
Ounce

Ounce  
40

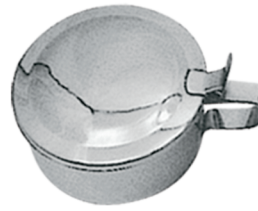

**SF-1714**  
Spitten Mug

Spitten Mug



**SF-1715**  
Spirit Lamp

Spirit Lamp

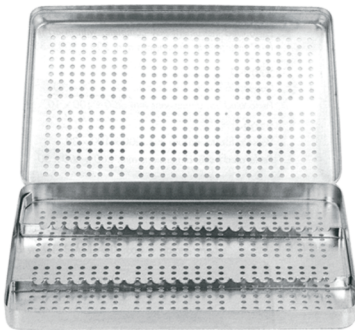

**SF-1716**  
Perforated Tray

Perforated Tray  
288 X 187 X 40 mm  
180 X 140 X 40 mm



**SF-1717**  
Perforated Base

Perforated Base  
288 X 187 X 40 mm  
180 X 140 X 40 mm

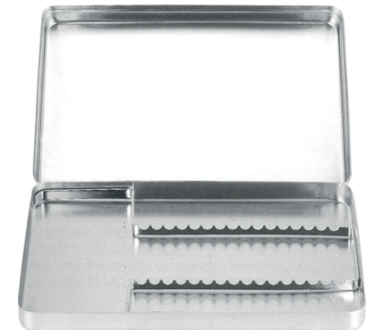

**SF-1718**  
Solid Base

Solid Base  
288 X 187 X 40 mm  
180 X 140 X 40 mm



**SF-1719**  
Instruments Tray

Instruments Tray  
8" X 4" X 1"



**SF-1720**  
Instruments Tray with Cover

Instruments Tray with Cover  
8" X 6" X 2"  
10" X 8" X 2"  
12" X 7" X 2"



**SF-1721**  
Instruments Tray Perforated

Instruments Tray Perforated  
12" X 6" X 1"



**SF-1722**  
Instruments Tray Shallow Mayo

Instruments Tray Shallow Mayo  
8" X 6" X 1 1/2"  
9" X 6" X 1 1/2"  
12" X 8" X 2"



**SF-1723**  
Scaler Tray

Scaler Tray  
200 X 100 X 15 mm  
200 X 150 X 15 mm



**SF-1724**  
Catheter Tray

Catheter Tray  
222 X 82 X 40 mm  
225 X 125 X 50 mm  
325 X 90 X 50 mm



# Surgiforce Instruments



Opposite Surgical Association,  
Malkay Kalan, Marala Road,  
Sialkot-51050 Pakistan.



+92 523 559131



info@surgiforce.com  
sales@surgiforce.com



www.surgiforce.com



## Our Certifications:

ISO 9001

CE Certified

EN 13485:2012

ISO 7153-1

ISO 7151

ISO 17664:2004

ISO 13402

ISO 15223



No.3012922148